

NOBLE
91 mm

NOB 1251 / نوب ١٢٥١

Kasa Profili	Ağırlık :1790 gr/m.
Frame Profile	Weight :1790 gr/m.
Рама	Bec :1790 gr/m
بروفيل الإطار	الوزن : ١٧٩٠ غ /م

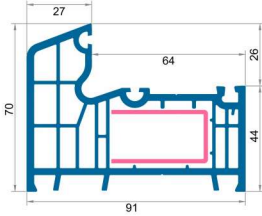

NOB 1252 / نوب ١٢٥٢

Kanat Profili	Ağırlık :2060 gr/m.
Sash profile Profile	Weight :2060 gr/m.
Створка	Bec :2060 rp/m
بروفيل الضلعة	الوزن : ٢٠٦٠ غ /م

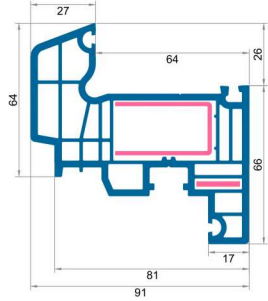

NOB1253 / نوب ١٢٥٣

Ortakayıt Profili	Ağırlık :2120 gr/m.
Mullion Profile	Weight :2120 gr/m.
Импост	Bec :2120 rp/m
بروفيل تي	الوزن : ٢١٢٠ غ /م

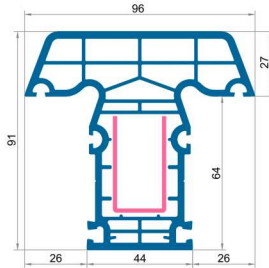

NOB 1255 / ١٢٥٥ نوب

Diş Açılım Kapı Kanadı Profili	Ağırlık : 2720 gr/m.
Out turn Door Sash Profile	Weight : 2720 gr/m.
дверная створка открытие наружу	Вес : 2720 гр/м
بروفيل ضلقة الباب الفتح إلى الخارج	الوزن : ٢٧٢٠ غ / م

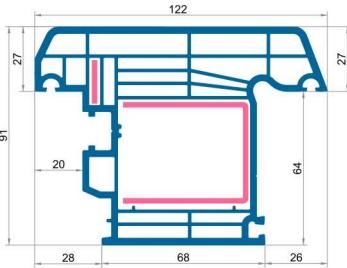

ADV 1159 / ١١٥٩ نوب

Hareketli Ortakayıt Profili	Ağırlık : 1380 gr/m.
False Mullion Profile	Weight : 1380 gr/m.
Штупельный профиль	Вес : 1380 гр/м
بروفيل تي المتحركة	الوزن : ١٣٨٠ غ / م

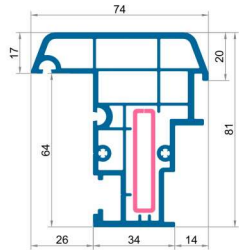

NOB 1254 / ١٢٥٤ نوب

İçe Açılım Damlalıklı Kapı Kanadı Profili	Ağırlık : 2650 gr/m.
In turn door sash Profile	Weight : 2650 gr/m.
Дверная створка открытие вовнутрь с водоотливом	Вес : 2650 гр/м
بروفيل ضلقة الباب فتح إلى الداخل بمسيل المطر	الوزن : ٢٦٥٠ غ / م

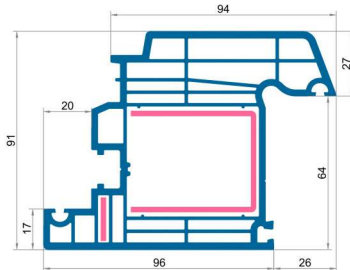

Çıtalar - Glazing Beads - Штапики - مثبت الزجاج

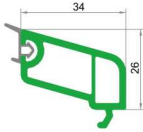
**NOB 1256 / ١٢٥٦** نوب

24 mm. Çift Cam Çıtası	Ağırlık : 340 gr/m.
Double Glazing bead for 24mm.	Weight : 340 gr/m.
Штапик 24 мм стеклопакета	Вес : 340 гр/м
مثبت الزجاج للزجاج المزدوج ٢٤ ملم	الوزن : ٣٤٠ غ / م .

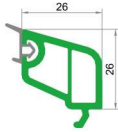
**NOB 1257 / ١٢٥٧** نوب

32 mm. Cam Çıtası	Ağırlık : 300 gr/mt
Double Glazing bead for 32 mm.	Weight : 300 gr/mt
Штапик 32 мм стеклопакета	Вес : 300 гр/м
مثبت الزجاج للزجاج المزدوج ٣٢ ملم	الوزن : ٣٠٠ غ / م .

**NOB 1258 / ١٢٥٨** نوب

44 mm. Cam Çıtası	Ağırlık : 230 gr/mt
Double Glazing bead for 44 mm.	Weight : 230 gr/mt
Штапик 44 мм стеклопакета	Вес : 230 гр/м
مثبت الزجاج للزجاج المزدوج ٤٤ ملم	الوزن : ٢٣٠ غ / م .

Kasa - Kanat Uygulaması

Frame - Sash, cross - section / Применение рама-створка / تطبيق الإطار مع الضلعة

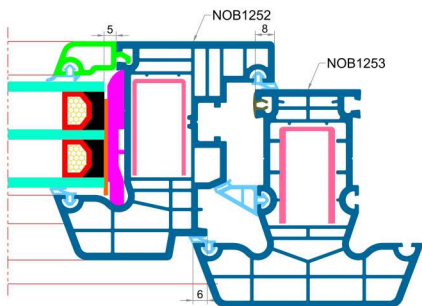
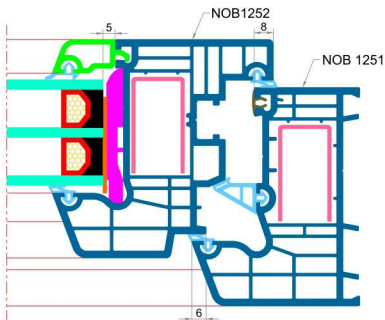

Kasa - Kanat Uygulaması

Frame - Sash, cross - section / Применение рама-створка / تطبيق الإطار مع الضلعة

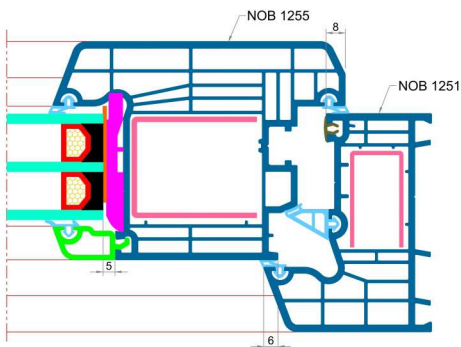
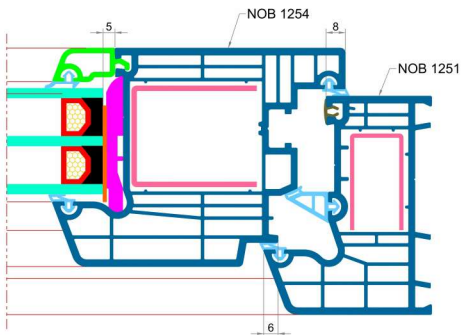

Sabit Ortakayıt Uygulaması

Fixed mullion cross - section / Применение неподвижного импоста / تطبيق بروفيل تي

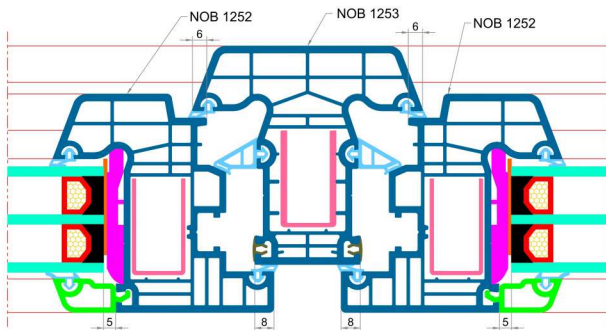

Hareketli Ortakayıt Uygulaması

False mullion cross - section / Применение шульпового профиля / تطبيق بروفيل تي المتحرك

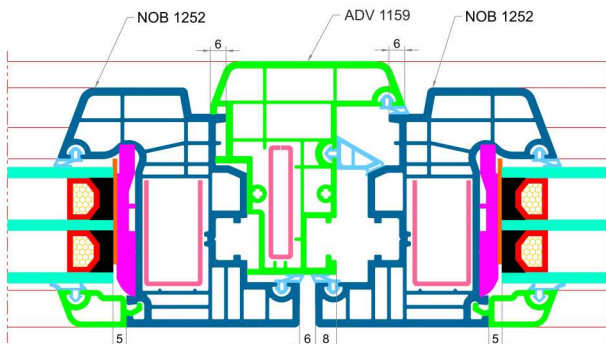

Bağ Profili Uygulaması

Coupling profile cross - section / Применение соединительного профиля / تطبيق بروفيل الربط

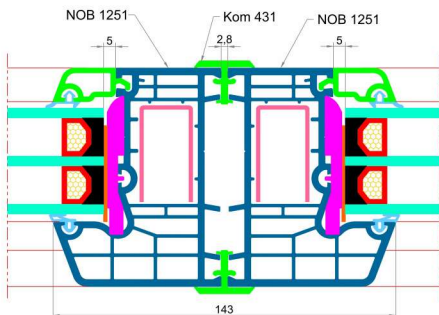

Griyaj Uygulaması

Support cross - section / Применение профиля поддержки / تطبيق بروفيل تأييد تي

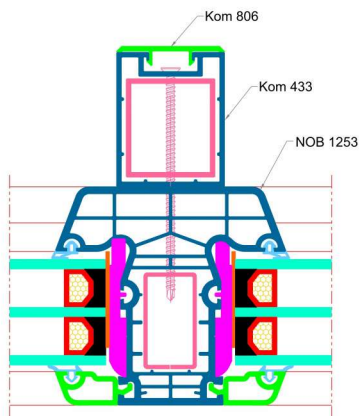

Destek Sacı - Reinforcement profile - Усилитель - حديد التسليح

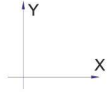

NOB
1251
1252
1253

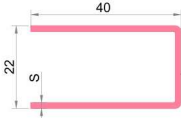

Kalınlık Thickness	Ağırlık Weight	Ix	Iy
1.20 mm	850 g/m	1.10 cm ⁴	1.97 cm ⁴
1.50 mm	1060 g/m	1.34 cm ⁴	2.43 cm ⁴
2.00 mm	1400 g/m	1.69 cm ⁴	3.17 cm ⁴

NOB
1251
1252
1253

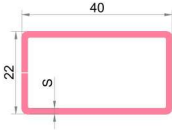

Kalınlık Thickness	Ağırlık Weight	Ix	Iy
1.20 mm	1010 g/m	1.17 cm ⁴	2.95 cm ⁴
1.50 mm	1250 g/m	1.41 cm ⁴	3.62 cm ⁴
2.00 mm	1650 g/m	1.78 cm ⁴	4.63 cm ⁴

NOB
1254
1255

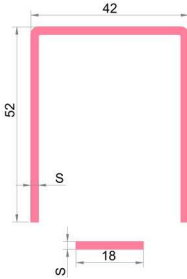

Kalınlık Thickness	Ağırlık Weight	Ix	Iy
1.20 mm	1250 g/m	5.29 cm ⁴	6.03 cm ⁴
1.50 mm	1560 g/m	6.55 cm ⁴	7.42 cm ⁴
2.00 mm	2070 g/m	8.60 cm ⁴	9.61 cm ⁴

Kalınlık Thickness	Ağırlık Weight	Ix	Iy
2.00 mm	270 g/m	0.01 cm ⁴	0.09 cm ⁴

ADV
1159

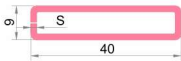

Kalınlık Thickness	Ağırlık Weight	Ix	Iy
1.20 mm	790 g/m	0.15 cm ⁴	1.78 cm ⁴
1.50 mm	890 g/m	0.17 cm ⁴	2.17 cm ⁴
2.00 mm	1280 g/m	0.20 cm ⁴	2.75 cm ⁴

ADV
1159

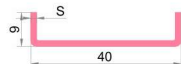

Kalınlık Thickness	Ağırlık Weight	Ix	Iy
1.20 mm	480 g/m	0.04 cm ⁴	1.30 cm ⁴
1.50 mm	590 g/m	0.05 cm ⁴	1.60 cm ⁴
2.00 mm	780 g/m	0.06 cm ⁴	2.04 cm ⁴