

advance
81 mm

ADV 1151 / ١١٥١ آدو

| | |
|---------------|---------------------|
| Kasa Profili | Ağırlık :1600 gr/m. |
| Frame Profile | Weight :1600 gr/m. |
| Pama | Bec :1600 rp/m |
| بروفيل الإطار | الوزن : م / غ ١٦٠٠ |

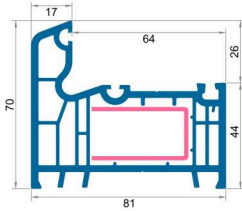

NOB 1252 / ١٢٥٢ نوب

| | |
|---------------|---------------------|
| Kanat Profili | Ağırlık :2060 gr/m. |
| Sash Profile | Weight :2060 gr/m. |
| Створка | Bec :2060 rp/m |
| بروفيل الضلعة | الوزن : م / غ ٢٠٦٠ |

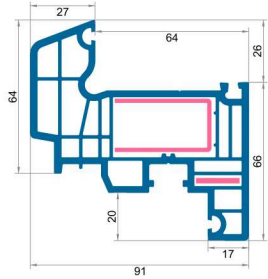

ADV 1153 / ١١٥٣ آدو

| | |
|-------------------|---------------------|
| Ortakayıt Profili | Ağırlık :1870 gr/m. |
| Mullion Profile | Weight :1870 gr/m. |
| Импост | Bec :1870 rp/m |
| بروفيل تي | الوزن : م / غ ١٨٧٠ |

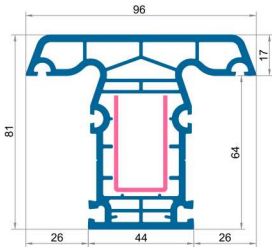

NOB 1254 / ١٢٥٤ نوب

| | |
|---|---------------------|
| İçe Açılım Damlalıklı Kapı Kanadı Profili | Ağırlık :2650 gr/m. |
| In turn door sash Profile | Weight :2650 gr/m. |
| Дверная створка открытие вовнутрь с водоотливом | Bec :2650 rp/m |
| بروفيل ضلعة الباب فتح الى الداخل بمسيل المطر | الوزن : م / غ ٢٦٥٠ |

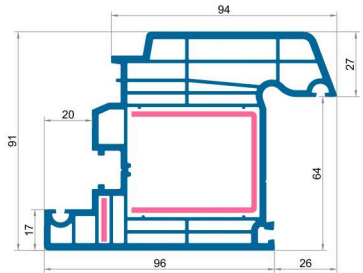

NOB 1255 / نوب ١٢٥٥

| | |
|------------------------------------|----------------------|
| Dışa Açılım Kapı Kanadı Profili | Ağırlık : 2720 gr/m. |
| Out turn Door Sash Profile | Weight : 2720 gr/m. |
| дверная створка открытие наружу | Вес : 2720 гр/м |
| بروفیل ضلقة الباب الفتح إلى الخارج | الوزن : ٢٧٢٠ غ / م |

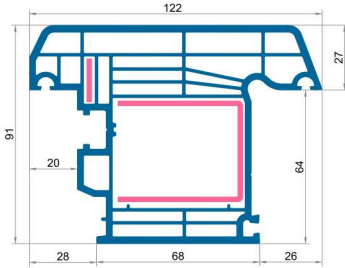

ADV 1159 / أدو ١١٥٩

| | |
|-----------------------------|----------------------|
| Hareketli Ortakayıt Profili | Ağırlık : 1380 gr/m. |
| False Mullion Profile | Weight : 1380 gr/m. |
| Штупельный профиль | Вес : 1380 гр/м |
| بروفیل تی المتحرکه | الوزن : ١٣٨٠ غ / م |

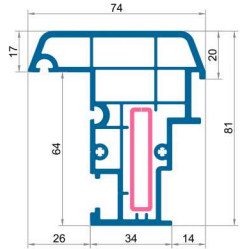

ADV 1158 / أدو ١١٥٨

| | |
|----------------------------|----------------------|
| Pervazlı Kasa Profili | Ağırlık : 1940 gr/m. |
| Frame with Cornice Profile | Weight : 1940 gr/m. |
| Рама с откосом | Вес : 1940 гр/м |
| بروفیل الإطار بكشف | الوزن : ١٩٤٠ غ / م |

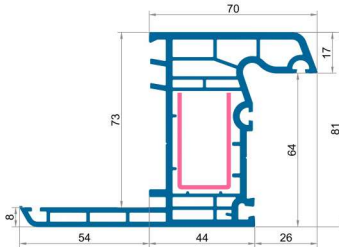

Çıtalar - Glazing Beads - Штапики - مثبت الزجاج

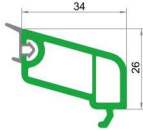
**NOB 1256 / ١٢٥٦** نوب

| | |
|-----------------------------------|---------------------|
| 24 mm. Çift Cam Çıtası | Ağırlık : 340 gr/m. |
| Double Glazing bead for 24mm. | Weight : 340 gr/m. |
| Штапик 24 мм стеклопакета | Bec : 340 gr/m |
| مثبت الزجاج للزجاج المزدوج ٢٤ ملم | الوزن : ٣٤٠ غ / م |

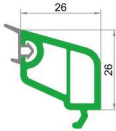
**NOB 1257 / ١٢٥٧** نوب

| | |
|-----------------------------------|---------------------|
| 32 mm. Cam Çıtası | Ağırlık : 300 gr/mt |
| Double Glazing bead for 32 mm. | Weight : 300 gr/mt |
| Штапик 32 мм стеклопакета | Bec : 300 gr/m |
| مثبت الزجاج للزجاج المزدوج ٣٢ ملم | الوزن : ٣٠٠ غ / م |

**NOB 1258 / ١٢٥٨** نوب

| | |
|-----------------------------------|---------------------|
| 44 mm. Cam Çıtası | Ağırlık : 230 gr/mt |
| Double Glazing bead for 44 mm. | Weight : 230 gr/mt |
| Штапик 44 мм стеклопакета | Bec : 230 gr/m |
| مثبت الزجاج للزجاج المزدوج ٤٤ ملم | الوزن : ٢٣٠ غ / م |

Kasa - Kanat Uygulaması

Frame - Sash, cross - section / Применение рама-створка / تطبيق الإطار مع الضلفة

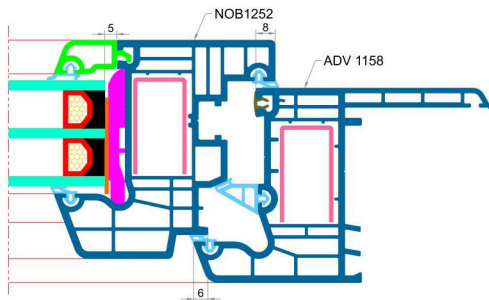
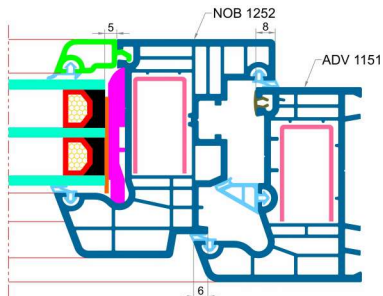

Kasa - Kanat Uygulaması

Frame - Sash, cross - section / Применение рама-створка / تطبيق الإطار مع الضلعة

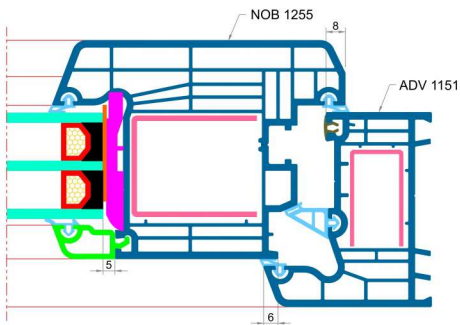
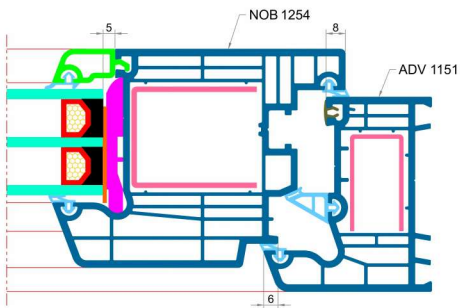

Sabit Ortakayıt Uygulaması

Fixed mullion cross - section / Применение неподвижного импоста / تطبيق بروفييل تي

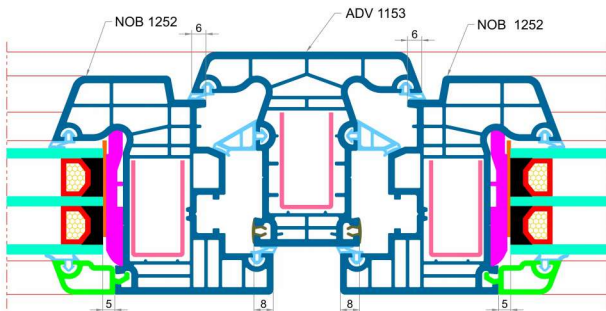

Hareketli Ortakayıt Uygulaması

False mullion cross - section / Применение штупльового профиля / تطبيق بروفييل تي المتحرك

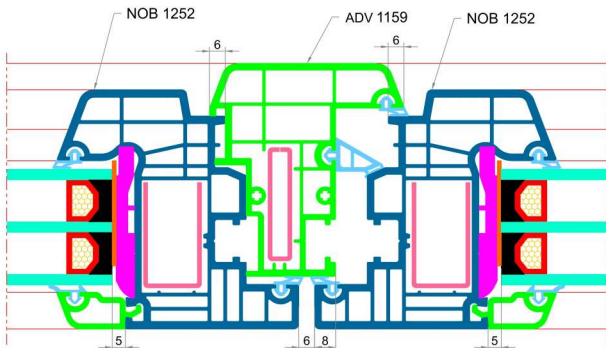

Bağ Profili Uygulaması

Coupling profile cross - section / Применение соединительного профиля / تطبيق بروفيل الربط

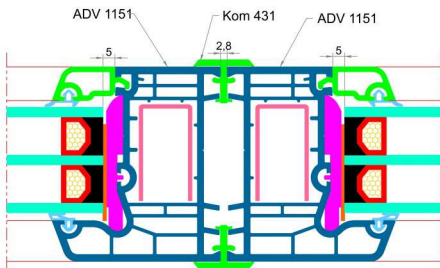

Griyaj Uygulaması

Support cross - section / Применение профиля поддержки / تطبيق بروفيل تأييد تي

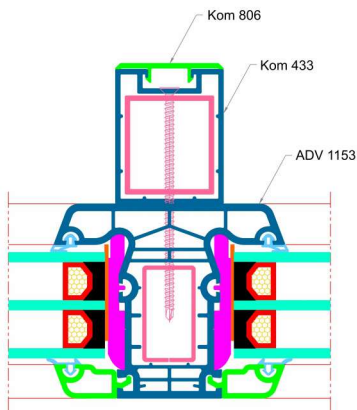

Destek Sacı - Reinforcement profile - Усилитель - حديد التسليح

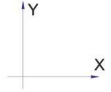

ADV
1151
1152
1153

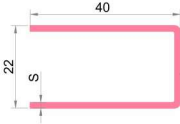

| Kalınlık Thickness | Ağırlık Weight | Ix | Iy |
|-----------------------|-------------------|----------------------|----------------------|
| 1.20 mm | 850 g/m | 1.10 cm ⁴ | 1.97 cm ⁴ |
| 1.50 mm | 1060 g/m | 1.34 cm ⁴ | 2.43 cm ⁴ |
| 2.00 mm | 1400 g/m | 1.69 cm ⁴ | 3.17 cm ⁴ |

ADV
1151
1152
1153

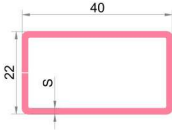

| Kalınlık Thickness | Ağırlık Weight | Ix | Iy |
|-----------------------|-------------------|----------------------|----------------------|
| 1.20 mm | 1010 g/m | 1.17 cm ⁴ | 2.95 cm ⁴ |
| 1.50 mm | 1250 g/m | 1.41 cm ⁴ | 3.62 cm ⁴ |
| 2.00 mm | 1650 g/m | 1.78 cm ⁴ | 4.63 cm ⁴ |

NOB
1254
1255

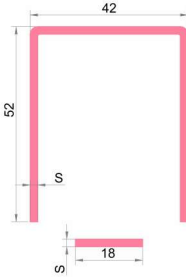

| Kalınlık Thickness | Ağırlık Weight | Ix | Iy |
|-----------------------|-------------------|----------------------|----------------------|
| 1.20 mm | 1250 g/m | 5.29 cm ⁴ | 6.03 cm ⁴ |
| 1.50 mm | 1560 g/m | 6.55 cm ⁴ | 7.42 cm ⁴ |
| 2.00 mm | 2070 g/m | 8.60 cm ⁴ | 9.61 cm ⁴ |

| Kalınlık Thickness | Ağırlık Weight | Ix | Iy |
|-----------------------|-------------------|----------------------|----------------------|
| 2.00 mm | 270 g/m | 0.01 cm ⁴ | 0.09 cm ⁴ |

ADV
1159

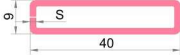

| Kalınlık Thickness | Ağırlık Weight | Ix | Iy |
|-----------------------|-------------------|----------------------|----------------------|
| 1.20 mm | 790 g/m | 0.15 cm ⁴ | 1.78 cm ⁴ |
| 1.50 mm | 890 g/m | 0.17 cm ⁴ | 2.17 cm ⁴ |
| 2.00 mm | 1280 g/m | 0.20 cm ⁴ | 2.75 cm ⁴ |

ADV
1159

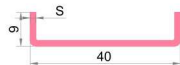

| Kalınlık Thickness | Ağırlık Weight | Ix | Iy |
|-----------------------|-------------------|----------------------|----------------------|
| 1.20 mm | 480 g/m | 0.04 cm ⁴ | 1.30 cm ⁴ |
| 1.50 mm | 590 g/m | 0.05 cm ⁴ | 1.60 cm ⁴ |
| 2.00 mm | 780 g/m | 0.06 cm ⁴ | 2.04 cm ⁴ |