

MPG
METALPLAST GROUP

PROFİL KATALOĐU SİSTEM SERİLERİ

www.metalplastgroup.com



METALPLAST GROUP

İÇİNDEKİLER INDEX



GXY H58 ISI YALITIMLI KAPI VE PENCERE SİSTEMLERİ	19
<i>GXY H58 THERMAL INSULATED DOOR & WINDOW SYSTEMS</i>	
GXY H63 ISI YALITIMLI KAPI VE PENCERE SERİLERİ	97
<i>GXY H63 THERMAL INSULATED DOOR & WINDOW SYSTEMS</i>	
GXY H77 ISI YALITIMLI KAPI VE PENCERE SİSTEMLERİ	173
<i>GXY H77 THERMAL INSULATED DOOR & WINDOW SYSTEMS</i>	
GXY 55 HEBESCHIEBE SÜRME SERİ	243
<i>GXY 55 HEBESCHIEBE SLIDING SERIES</i>	
GXY H43 ISI YALITIMLI SÜRME SERİ	279
<i>GXY H43 THERMAL INSULATED DOOR & WINDOW SYSTEMS</i>	
GXY HEKO SERİ	301
<i>HEKO SLIDING SERIES</i>	
HEKO SİNEKLİK SÜRME SERİ	321
<i>GXY HEKO SLIDING WINDOW WITH SCREEN</i>	
GXY KAPAKLI VE SİLİKON CEPHE	343
<i>GXYCURTAIN WALL SYSTEMS [STRUCTURAL SILICON SYSTEM / STRUCTURAL CLIPS SYSTEM]</i>	
GXY H50 SG CAM İÇİ KİLİTME SİSTEMLERİ	427
<i>INTERLOCKING GLASS SYSTEMS</i>	
GXY H45 ISI YALITIMSIZ KAPI VE PENCERE SİSTEMİ	467
<i>GXY H45 THERMAL UNINSULATED DOOR & WINDOW SYSTEMS</i>	
GXY H55 ISI YALITIMSIZ KAPI VE PENCERE SİSTEMLERİ	501
<i>GXY H55 THERMAL UNINSULATED DOOR & WINDOW SYSTEMS</i>	
GXY H57 ISI YALITIMSIZ KAPI VE PENCERE SİSTEMLERİ	531
<i>GXY H57 THERMAL UNINSULATED DOOR & WINDOW SYSTEMS</i>	
GXY HEKO DOĞRAMA SERİSİ	569
<i>GXY HEKO DOOR&WINDOW SERIES</i>	



PROFİL KATALOĐU

GXY H58 ISI YALITIMLI KAPI VE PENCERE SİSTEMLERİ

*GXY H58 THERMAL INSULATED DOOR &
WINDOW SYSTEMS*













* Profil Ađırlıkları Teorik Olup Teslim Anındaki Ađırlık Geerlidir

* *Weight of profiles are theoretical, net weight will valid at the time of delivery.*















★ Yandaki profil birim ağırlıkları, bilgisayarda hesaplanmış teorik ağırlıklardır.

PROFİL KESİTİ	PROFİL KODU	PROFİL ADI	AĞIRLIK	ATALET MOMENTLERİ		SAYFA NO
				J_x (cm ⁴)	J_y (cm ⁴)	
	2909/10 (1.6 mm)	Dar Kasa Profili	1,319 kg/m	17,20	5,99	
	2909/13 (1.6mm)	Dar Orta Kayıt Profili	1,424 kg/m	18,67	9,51	
	2911/12 (1.6mm)	Dar Kanat Profili	1,435 kg/m	28,76	6,52	
	2650/51 (1.4mm)	Geniş Kasa Profili	1,387 kg/m	18,86	10,22	
	2650/51 (1.6mm)	Geniş Kasa Profili	1,510 kg/m	20,94	12,69	
	2650/51 (1.8mm)	Geniş Kasa Profili	1,595 kg/m	22,44	13,22	
	4718/19 (1.4mm)	Oval Kasa Profili	1,845 kg/m	37,22	24,55	
	4452/53 (1.6mm)	Geniş Kasa Profili	1,702 kg/m	24,67	17,95	
	4452/53 (1.8mm)	Geniş Kasa Profili	1,779 kg/m	26,12	19,00	
	4894/4895 (1.4mm)	Pervazlı Kasa Profili	1,569 kg/m	32,90	12,65	
	2651/52 (1.4mm)	Geniş Orta Kayıt Profili	1,492 kg/m	20,10	16,6	
	2651/52 (1.6mm)	Geniş Orta Kayıt Profili	1,628 kg/m	21,63	16,70	
	2651/52 (1.8mm)	Geniş Orta Kayıt Profili	1,700 kg/m	23,44	18,13	
	2933/34 (1.6mm)	Baza Orta Kayıt Profili	2,038 kg/m	47,83	28,20	















★ Yandaki profil birim ağırlıkları, bilgisayarda hesaplanmış teorik ağırlıklardır.

PROFİL KESİTİ	PROFİL KODU	PROFİL ADI	AĞIRLIK	ATALET MOMENTLERİ		SAYFA NO
				J_x (cm ⁴)	J_y (cm ⁴)	
	2651/4513 (1.6mm)	Takviyeli Orta Kayıt Profili	1,714 kg/m	65,26	21,77	
	2653/54 (1.4mm)	Geniş Kanat Profili	1,529 kg/m	32,93	12,19	
	2653/54 (1.6mm)	Geniş Kanat Profili	1,632 kg/m	34,58	12,95	
	2653/54 (1.8mm)	Geniş Kanat Profili	1,736 kg/m	36,24	13,69	
	4720/21 (1.4mm)	Oval Kanat Profili	1,538 kg/m	33,89	12,24	
	3478/79 (1.3mm)	Pvc Kanallı Pencere Kanadı	1,504 kg/m	31,52	9,46	
	2932/2654 (1.5mm)	Pvc Kanallı Pencere Kanadı	1,799 kg/m	49,45	15,02	
	2661/62 (1.6mm)	İçe Açılır Kapı Kanadı	2,169 kg/m	57,18	31,70	
	2661/62 (1.8mm)	İçe Açılır Kapı Kanadı	2,233 kg/m	58,55	32,97	
	3483/ 84 (1.3mm)	Pvc Kanallı Kapı Kanadı	1,886 kg/m	66,99	31,52	
	3483/ 84 (1.3mm)	Oval Kapı Kanadı	1,855 kg/m	55,07	26,19	
	2663/64 (1.6mm)	Dışa Açılır Kapı Kanadı	2,186 kg/m	53,73	39,61	
	2663/64 (1.8mm)	Dışa Açılır Kapı Kanadı	2,293 kg/m	55,90	42,58	
	2659 /60 (1.4mm)	Dışa Açılır Çift Kanat Adaptörü	1,229 kg/m	16,40	7,86	



★ Yandaki profil birim ağırlıkları, bilgisayarda hesaplanmış teorik ağırlıklardır.

PROFİL KESİTİ	PROFİL KODU	PROFİL ADI	AĞIRLIK	ATALET MOMENTLERİ		SAYFA NO
				J_x (cm ⁴)	J_y (cm ⁴)	
	2655 /56 (1.4mm)	Dışa Açılır Kanat Adaptörü	1,129 kg/m	14,39	4,66	
	2815 /16 (1.5mm)	İçe Açılır Çift Kanat Adaptörü	1,230 kg/m	16,48	7,92	
	3556 /57 (1.4mm)	PVC Kanallı Çift Kapı Adaptör Profili	1,315 kg/m	19,01	7,60	
	4899/4900 (1.5mm)	Pivot Kapı Adaptör Profili	1,354 kg/m	20,78	8,86	
	1909 /10 (1.5mm)	Etek Profili	2,123 kg/m	54,89	32,02	
	4733/34 (1.8mm)	Köşe Profili	1,943 kg/m	32,61	32,09	
	2935/36 (1.4mm)	Eşik Profili	0,860 kg/m	11,31	1,24	
	3154/55 (1.4mm)	Ek Profil	1,388 kg/m	43,27	3,20	
	4120	Eşik-Kanat Adaptör Profili-İç	0,245 kg/m	
	4121	Eşik-Kanat Adaptör Profili-Dış	0,279 kg/m	
	1404	Fugalı T Bini	0,399 kg/m	
	2260	Pervaz Profili	0,625 kg/m	
	2259	Pervaz Profili	0,486 kg/m	
	1210	İspanyolet Çubuğu	0,112 kg/m	



★ Yandaki profil birim ağırlıkları, bilgisayarda hesaplanmış teorik ağırlıklardır.

PROFİL KESİTİ	PROFİL KODU	PROFİL ADI	AĞIRLIK	ATALET MOMENTLERİ		SAYFA NO
				J_x (cm ⁴)	J_y (cm ⁴)	
	2660	Köşe Dönüş Adaptörü Dış	0,181 kg/m	
	2667	Köşe Dönüş Adaptörü İç	0,179 kg/m	
	4756	Cam Çıtası	0,300 kg/m	
	4124	Cam Çıtası	0,308 kg/m	
	2668	Cam Çıtası	0,330 kg/m	
	2657	Cam Çıtası	0,332 kg/m	
	2914	Cam Çıtası	0,349 kg/m	
	3136	Cam Çıtası	0,364 kg/m	
	3183	Cam Çıtası	0,377 kg/m	
	1416	45'lik Boru Profil	0,732 kg/m	
	2181	Damlalık Profili	0,168 kg/m	
	4125	Çektirme Takozu	1,099 kg/m	
	4133	Çektirme Takozu	0,566 kg/m	
	2929	Köşe Takozu	3,341 kg/m	











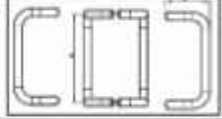

★ Yandaki profil birim ağırlıkları, bilgisayarda hesaplanmış teorik ağırlıklardır.

PROFİL KESİTİ	PROFİL KODU	PROFİL ADI	AĞIRLIK	ATALET MOMENTLERİ		SAYFA NO
				J_x (cm ⁴)	J_y (cm ⁴)	
	3545	Köşe Takoza	4,616 kg/m	
	2917	Köşe Takoza	3,469 kg/m	
	3546	Köşe Takoza	6,304 kg/m	

★ Yandaki profil birim ağırlıkları, bilgisayarda hesaplanmış teorik ağırlıklardır.

AKSESUAR KESİTİ	AKSESUAR KODU	AKSESUAR ADI	AĞIRLIK	PAKETLEME	SAYFA NO
	HL38	Orta Bini Fiteli	174 gr/m	15 kg/ 86m	
	HL48	Kanat Fiteli	73 gr/m	15 kg/ 205m	
	HL32	Dış Cam Fiteli	46 gr/m	15 kg/ 326m	
	HL31(2mm)	Kama Fiteli	40 gr/m	15 kg/ 375m	
	HL04(3mm)	Kama Fiteli	60 gr/m	15 kg/ 250m	
	HL07(4mm)	Kama Fiteli	63 gr/m	15 kg/ 238m	
	HL73	Eşik Fiteli	30 gr/m	15 kg/ 500m	
	HL38/VK	Köşe Fiteli (Vulkanize Köşe Contası)	20 gr/m	100 Ad/ Paket	
	MP-56-04/3-1	Köşe Gönye	...	100 Ad/ Paket	
	MP-HG58	Çift Kapı Adaptör Kapağı 1 Takım (Sağ- Sol)	...	25Sağ 25Sol/ 1 Paket	
	MP-6-36138 -20-LR-0-1	Menteşe	...	100 Ad/ 1 Paket	
	MP26-03/2	Menteşe	...	150 Ad/ 1 Paket	
	MP56-07/5H	Seri Sistem Mentese	...	200 Ad/ 1 Paket	

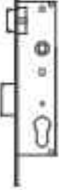

★ Yandaki profil birim ağırlıkları, bilgisayarda hesaplanmış teorik ağırlıklardır.

AKSESUAR KESİTİ	AKSESUAR KODU	AKSESUAR ADI	AĞIRLIK	PAKETLEME	SAYFA NO
	00535	Kapı Menteşe	...	200 Ad/ 1 Paket	
	MP31-02/09-1	Paslanmaz Tek Büküm Oval Yale Kol	...	30 Ad/ 1 Paket	
	MP31-11	Boru Kol	...	10 Ad/ 1 Paket	
	MP29-04	Alüminyum Pencere Kolu	...	100 Ad/ 1 Paket	
	MP32-01/1	Boyunlu Eksenel Kol Tek Dilli	...	50 Ad/ 1 Paket	
	MP31-01	Yaylı Sosis Kol	...	50 Ad/ 1 Paket	
	MP31-09/13	Yaylı Dar Aynalı Sosis Kol	...	30 Ad/ 1 Paket	
	MP31-07/2Y	Yaylı Düz Rozetli Sosis Kol	...	50 Ad/ 1 Paket	
	MP31-24/2H	Akbank Havuzlu Kol Aparatı	...	30 Ad/ 1 Paket	
	MP31-24/20	Akbank 40'lık Kol Aparatı	...	30 Ad/ 1 Paket	
	MP34-04/5	Dilli Kilit (153-35)	...	30 Ad/ 1 Paket	
	MP34-02/7	Makaralı Kilit (155-35)	...	30 Ad/ 1 Paket	

★ Yandaki profil birim ağırlıkları, bilgisayarda hesaplanmış teorik ağırlıklardır.

AKSESUAR KESİTİ	AKSESUAR KODU	AKSESUAR ADI	AĞIRLIK	PAKETLEME	SAYFA NO
	MP34-254/96	96 mm Barel	...	30 Ad/ 1 Paket	
	MP33-12	Isı yalıtımlı Uzun Sürgü	...	100 Ad/ 1 Paket	
	MP56-01/6/3-1	Dilli Kilit Karşılığı	...	50 Ad/ 1 Paket	
	MP56-01/6/6	Makaralı Kilit Karşılığı	...	50 Ad/ 1 Paket	
	MP28-02	(40,60,80,100,120) (140,160,180,200cm) 7,5 mm göbekli ispanyolet	...	50 Ad/ 1 Paket 30 Ad/ 1 Paket	
	MP32-34/3	İspanyolet Pim Takımı	...	100 Ad/ 1 Paket	
	MP33-09/4-3	Vasistas Makası	...	100 Ad/ 1 Paket	
	MP33-15/5	Cico Avrupa Vasistas Çitçit	...	50 Ad/ 1 Paket	
	MP32-33/1	Ayarlı Karşılık	...	500 Ad/ 1 Paket	
	TS 71	Kapı Hidroliği	...	10 Ad/ 1 Paket	
	MP33-04/2	Kapı Altı Fırçası	...	100 Ad/ 1 Paket	
	MP33-04/3	Y Kapı Alt Fırçası	...	100 Ad/ 1 Paket	
	MP26-05	Su Tahliye Tapası	...	2000 Ad/ 1 Paket	

★ Yandaki profil birim ağırlıkları, bilgisayarda hesaplanmış teorik ağırlıklardır.

AKSESUAR KESİTİ	AKSESUAR KODU	AKSESUAR ADI	AĞIRLIK	PAKETLEME	SAYFA NO
	HE-9991	Pvc Tij	...	200 m / 1 Paket	
	MP-9998	Kesme ve Delme Makinası	...	1 Ad/ Paket	

★ Yandaki profil birim ağırlıkları, bilgisayarlı hesaplanmış teorik ağırlıklardır.

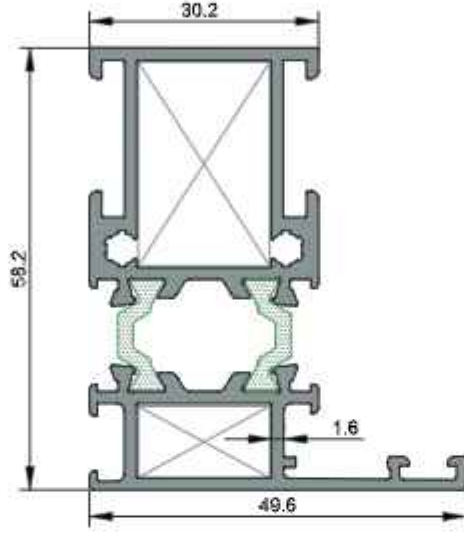

2909/10
Dar Kasa Profili
1,319 kg/m
Jx=17,20 cm ⁴ Jy=5,99 cm ⁴

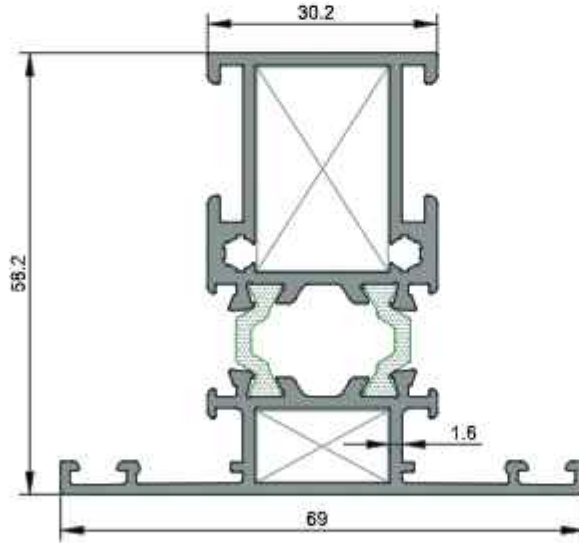

2909/13
Dar Orta Kayıt Profili
1,424 kg/m
Jx=18,67 cm ⁴ Jy=9,51 cm ⁴

★ Yandaki profil birim ağırlıkları, bilgisayarla hesaplanmış teorik ağırlıklardır.

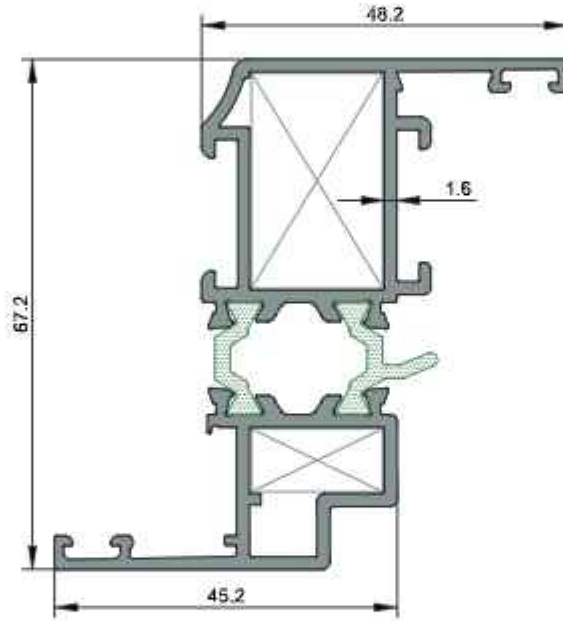

2911/12
Dar Kanat Profili
1,435 kg/m
Jx=28,76 cm ⁴ Jy=6,52 cm ⁴

★ Yandaki profil birim ağırlıkları, bilgisayarla hesaplanmış teorik ağırlıklardır.

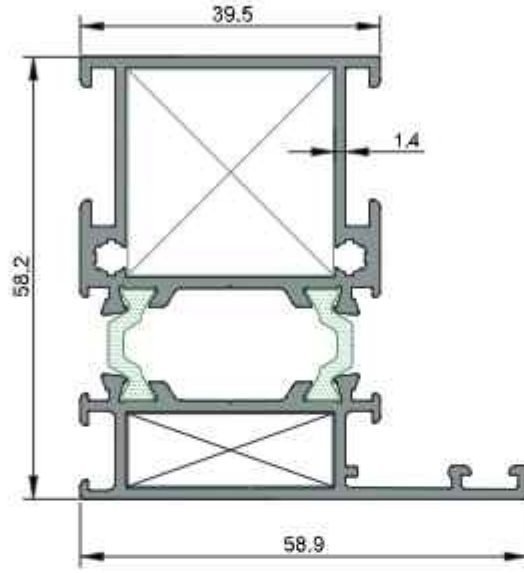

2650/51(1.4mm)
Geniş Kasa Profili
1,387 kg/m
Jx=18,86 cm ⁴ Jy=10,22 cm ⁴

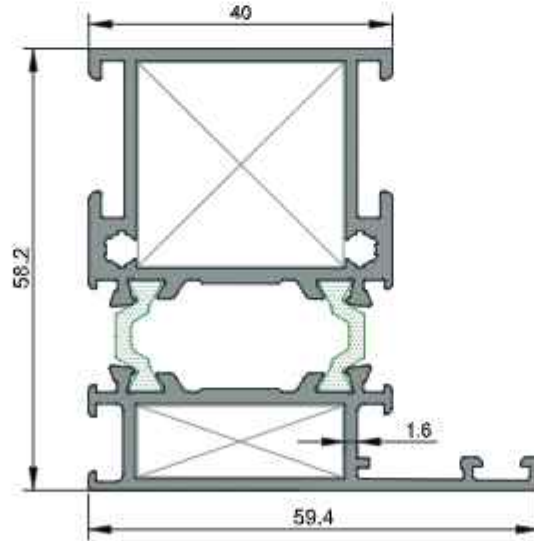

2650/51(1.6mm)
Geniş Kasa Profili
1,510 kg/m
Jx=20,94 cm ⁴ Jy=12,69 cm ⁴

★ Yandaki profil birim ağırlıkları, bilgisayarla hesaplanmış teorik ağırlıklardır.

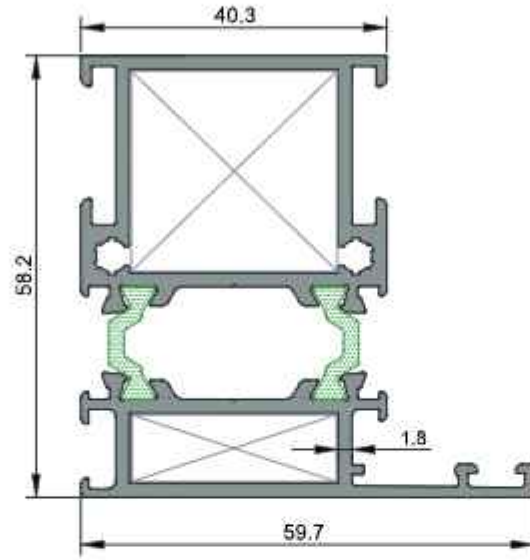

2650/51 (1.8mm)
Geniş Kasa Profili
1,595 kg/m
Jx=22,44 cm ⁴ Jy=13,22cm ⁴

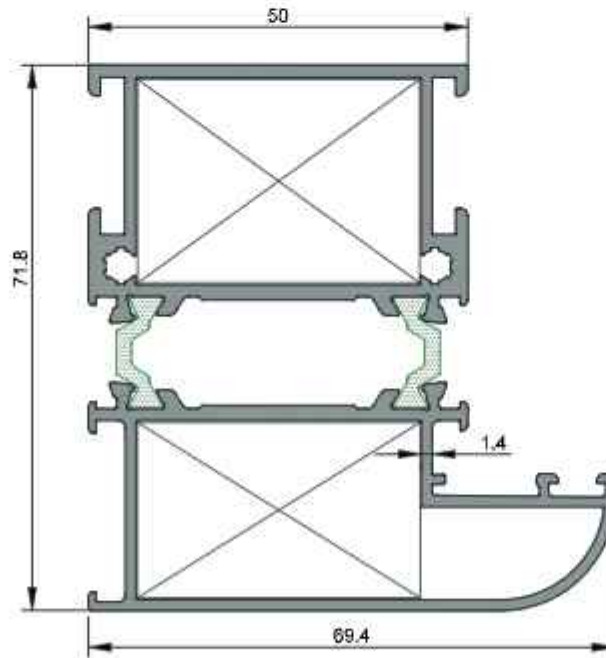

4718/4719 (1.4mm)
Oval Kasa Profili
1,845 kg/m
Jx=37,22 cm ⁴ Jy=24,55 cm ⁴

★ Yandaki profil birim ağırlıkları, bilgisayarla hesaplanmış teorik ağırlıklardır.

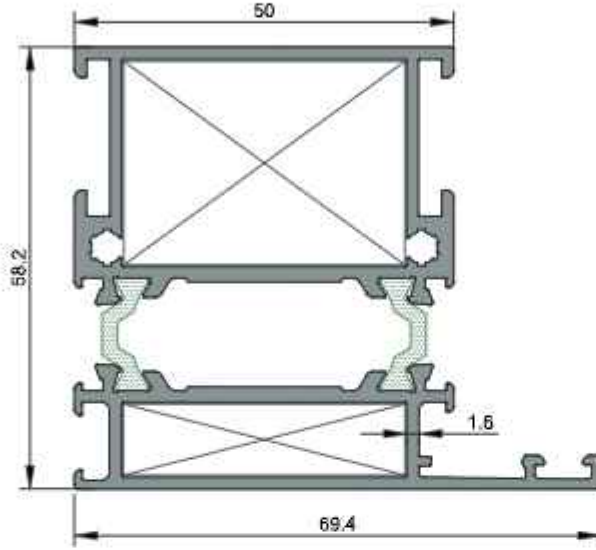

4452/53(1.6mm)
Geniş Kasa Profili
1,702 kg/m
$J_x=24,67 \text{ cm}^4$ $J_y=17,95 \text{ cm}^4$

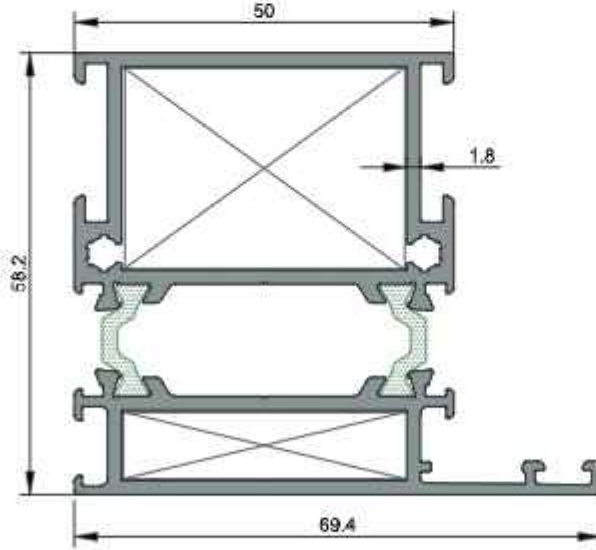

4452/53(1.8mm)
Geniş Kasa Profili
1,779 kg/m
$J_x=26,12 \text{ cm}^4$ $J_y=19,00 \text{ cm}^4$

★ Yandaki profil birim ağırlıkları, bilgisayarda hesaplanmış teorik ağırlıklardır.

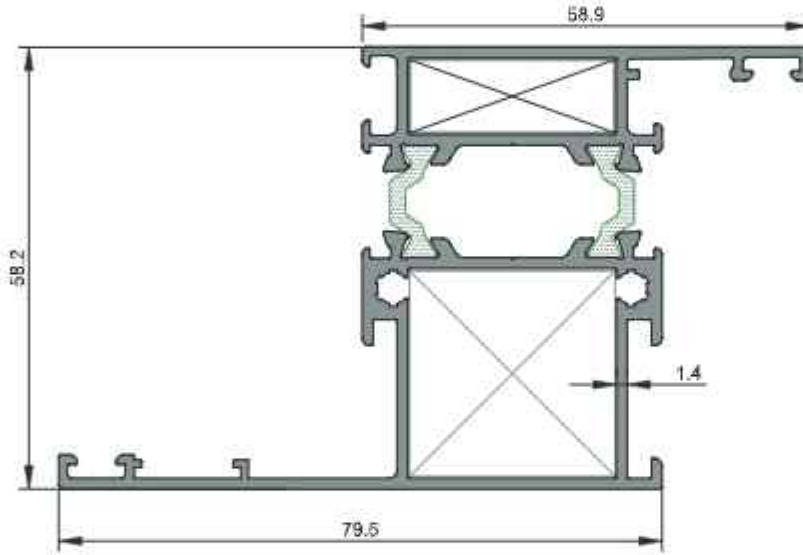

4894/4895
Pervazlı Kasa Profili
1,569 kg/m
$J_x=32,90 \text{ cm}^4$ $J_y=12,65 \text{ cm}^4$

★ Yandaki profil birim ağırlıkları, bilgisayarla hesaplanmış teorik ağırlıklardır.

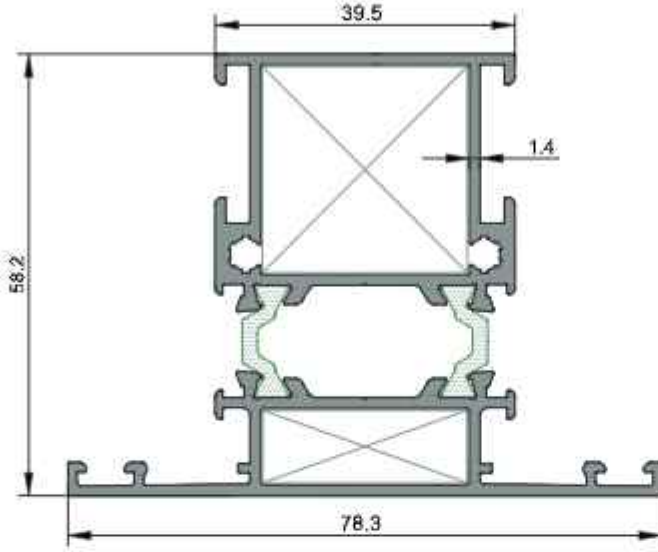

2651/52(1.4mm)
Geniş Orta Kayıt Profili
1,492 kg/m
Jx= 20,10 cm ⁴ Jy= 16,6 cm ⁴

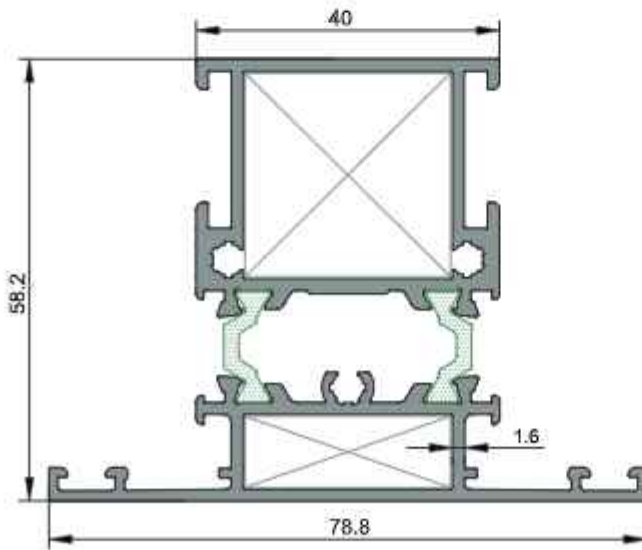

2651/52(1.6mm)
Geniş Orta Kayıt Profili
1,628 kg/m
Jx=21,63 cm ⁴ Jy=16,70cm ⁴

★ Yandaki profil birim ağırlıkları, bilgisayarla hesaplanmış teorik ağırlıklardır.

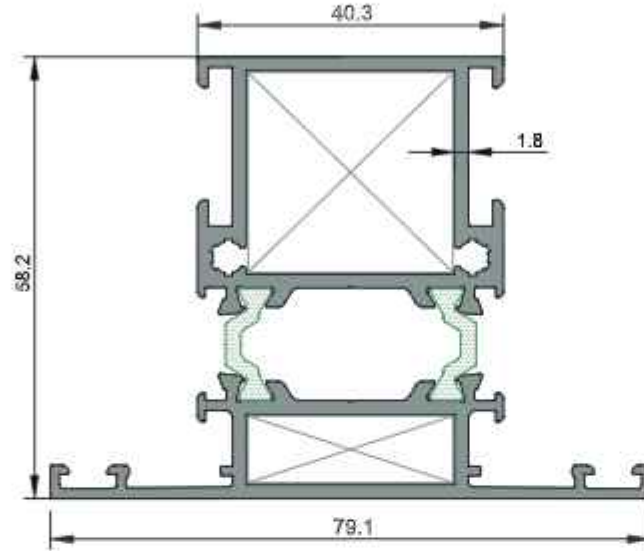

2651/52(1.8mm)
Geniş Orta Kayıt Profili
1,700 kg/m
Jx= 23,44 cm ⁴ Jy= 18,13 cm ⁴

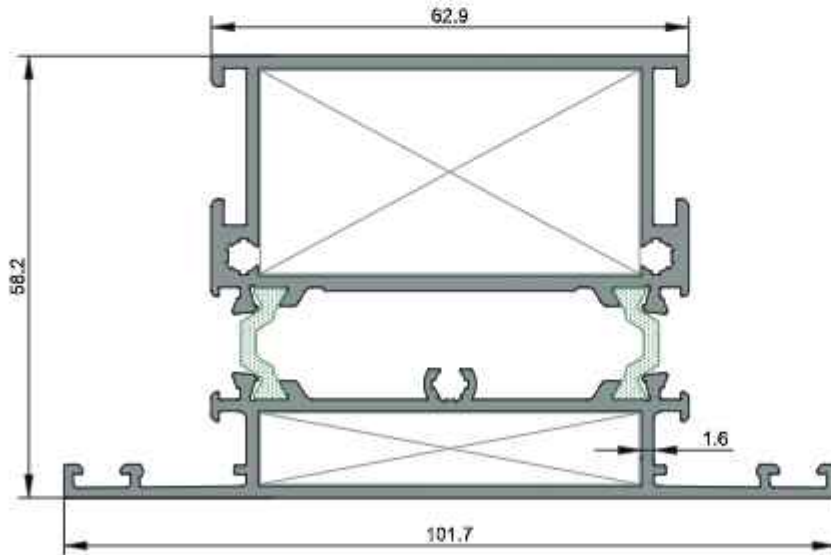

2933/34
Baza Orta Kayıt Profili
2,038 kg/m
Jx= 47,83 cm ⁴ Jy=28,20 cm ⁴

★ Yandaki profil birim ağırlıkları, bilgisayarda hesaplanmış teorik ağırlıklardır.

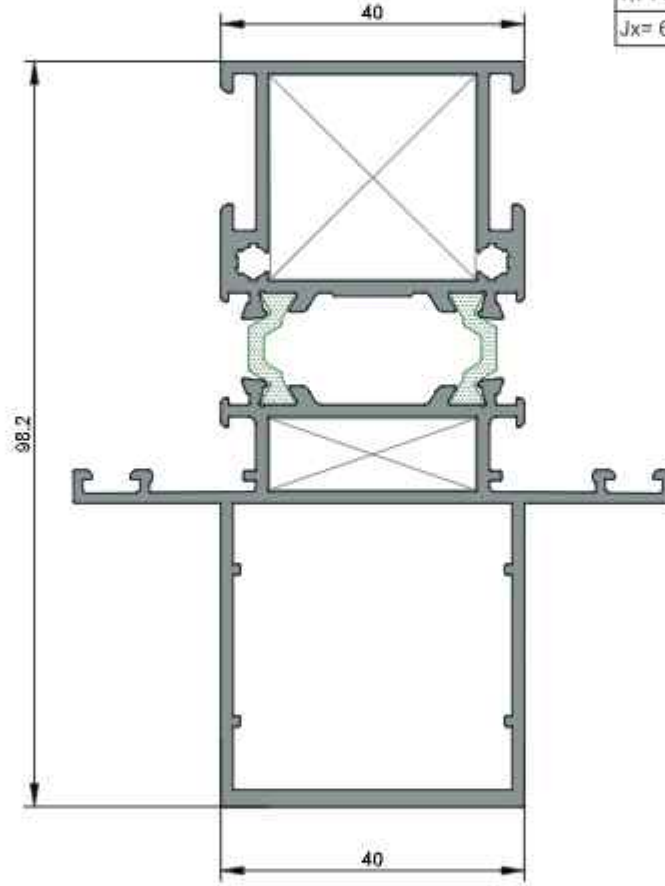

2651/4513
Takviyeli Orta Kayıt Profili
1,714 kg/m
$J_x=65,26 \text{ cm}^4$ $J_y=21,77 \text{ cm}^4$

★ Yandaki profil birim ağırlıkları, bilgisayarla hesaplanmış teorik ağırlıklardır.

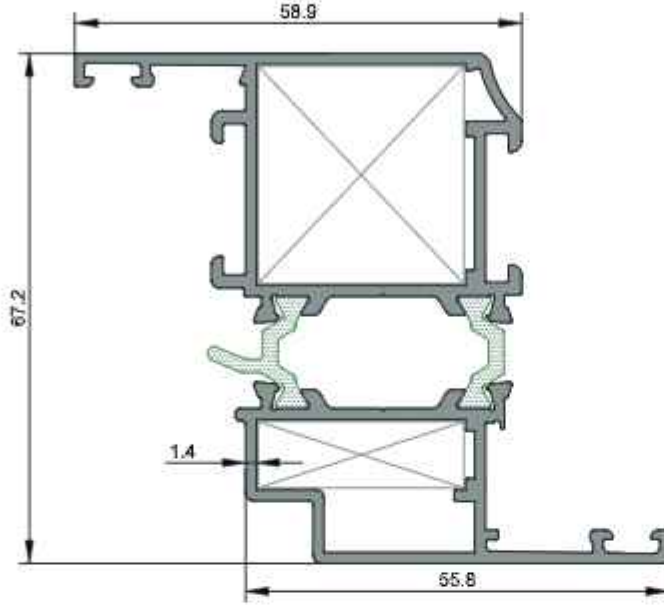

2653/54(1.4mm)
Geniş Kanat Profili
1,529 kg/m
Jx= 32,93cm ⁴ Jy=12,19cm ⁴

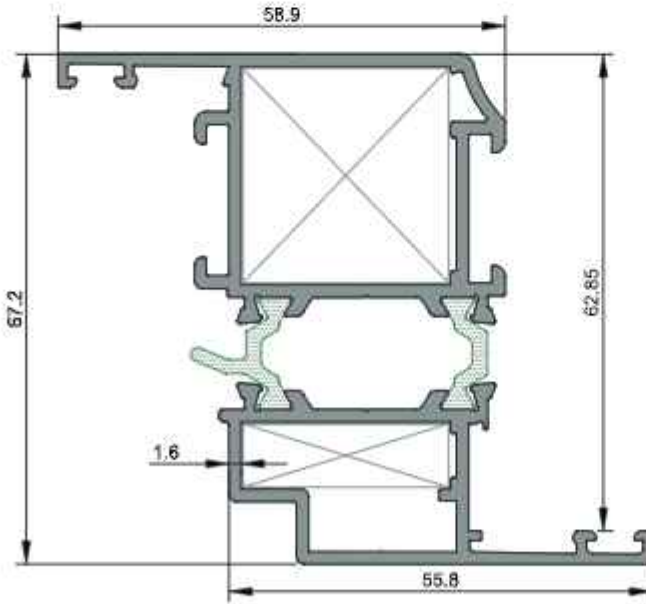

2653/54(1.6mm)
Geniş Kanat Profili
1,632 kg/m
Jx= 34,58 cm ⁴ Jy=12,95 cm ⁴

★ Yandaki profil birim ağırlıkları, bilgisayarda hesaplanmış teorik ağırlıklardır.

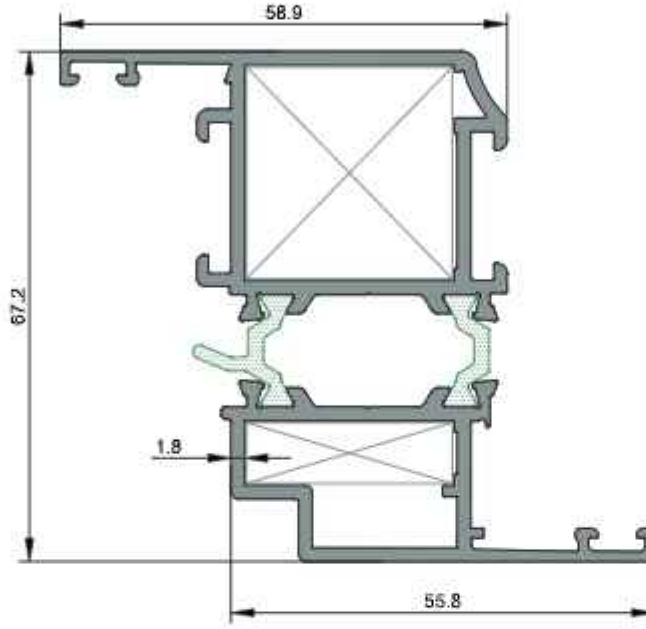

2653/54(1.8mm)
Geniş Kanat Profili
1,736 kg/m
$J_x=36,24\text{cm}^4$ $J_y=13,69\text{cm}^4$

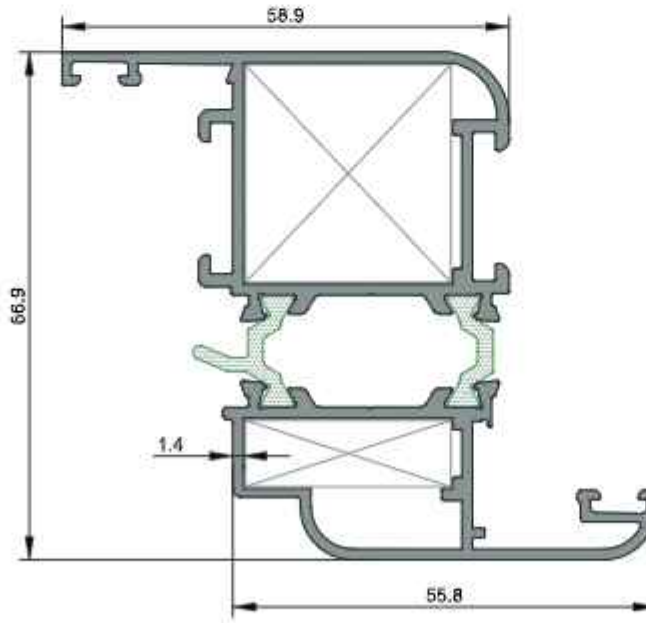

4720/4721
Oval Kanat Profili
1,538 kg/m
$J_x=33,89\text{cm}^4$ $J_y=12,24\text{cm}^4$

★ Yandaki profil birim ağırlıkları, bilgisayarla hesaplanmış teorik ağırlıklardır.

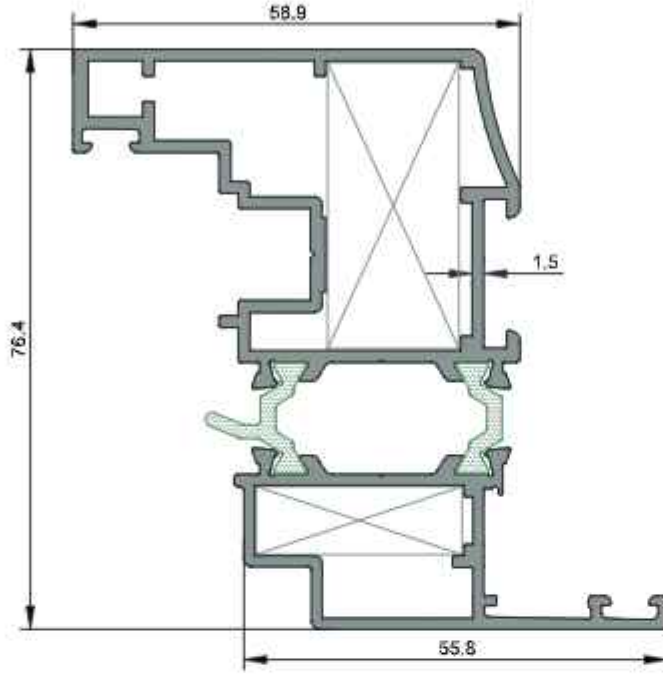

2932/2654
PVC Kanallı Pencere Kanadı
1,799 kg/m
Jx=49,45 cm ⁴ Jy=15,02 cm ⁴

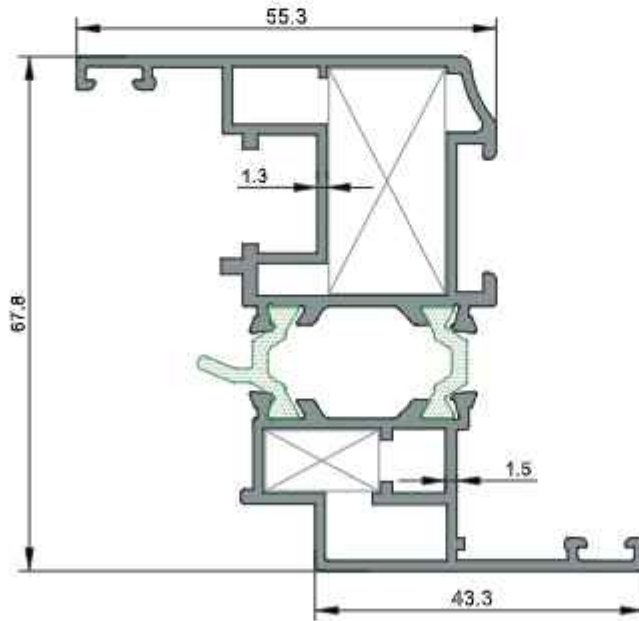

3478/79(1.3 mm)
PCV Kanallı Kanat Profili
1,504 kg/m
Jx= 31,52 cm ⁴ Jy=9,46 cm ⁴

★ Yandaki profil birim ağırlıkları, bilgisayarla hesaplanmış teorik ağırlıklardır.

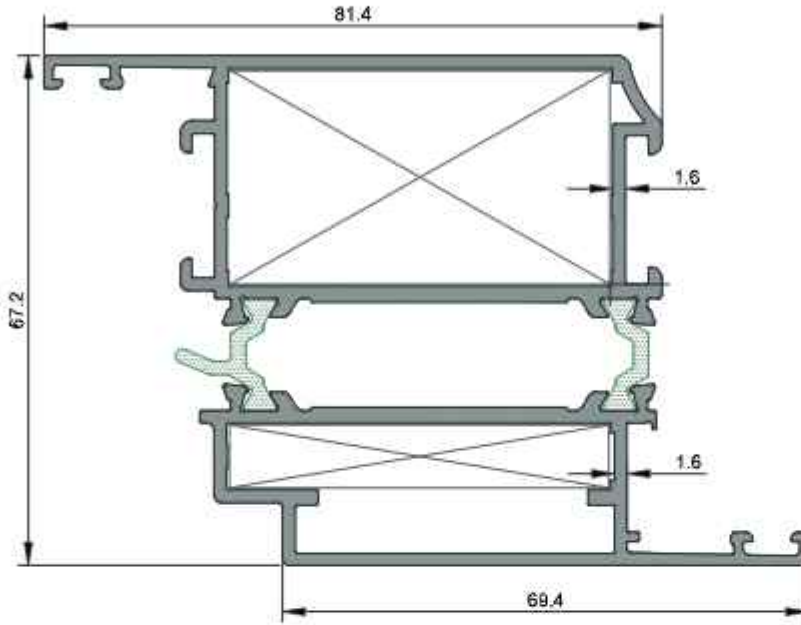

2661/62(1.6mm)
Kapı Kanadı
2,169 kg/m
Jx= 57,18 cm ⁴ Jy=31,70 cm ⁴

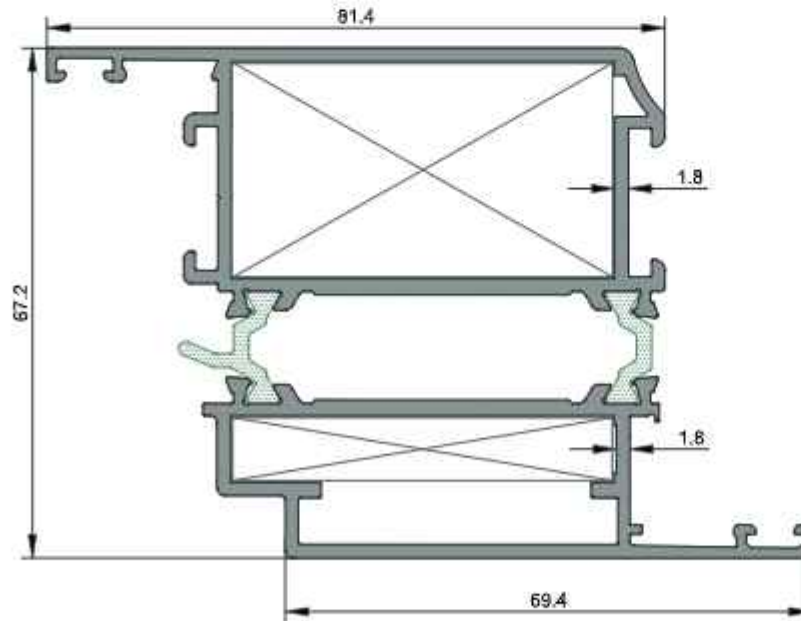

2661/62(1.8mm)
Kapı Kanat Profili
2,233 kg/m
Jx= 58,55 cm ⁴ Jy=32,97 cm ⁴

★ Yandaki profil birim ağırlıkları, bilgisayarla hesaplanmış teorik ağırlıklardır.

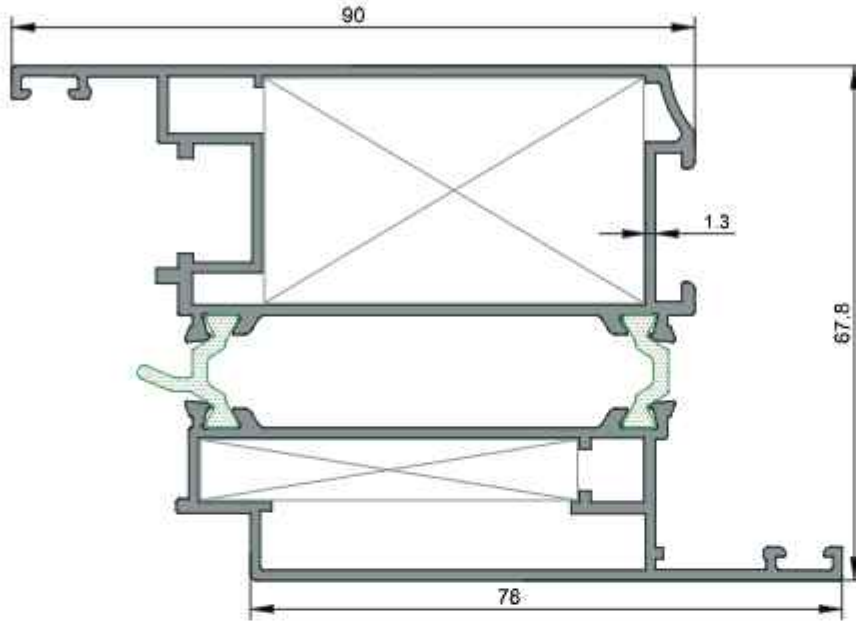

3483/84
PCV Kanallı Kapı Kanadı
1,886 kg/m
$J_x = 66,99 \text{ cm}^4$ $J_y = 31,52 \text{ cm}^4$

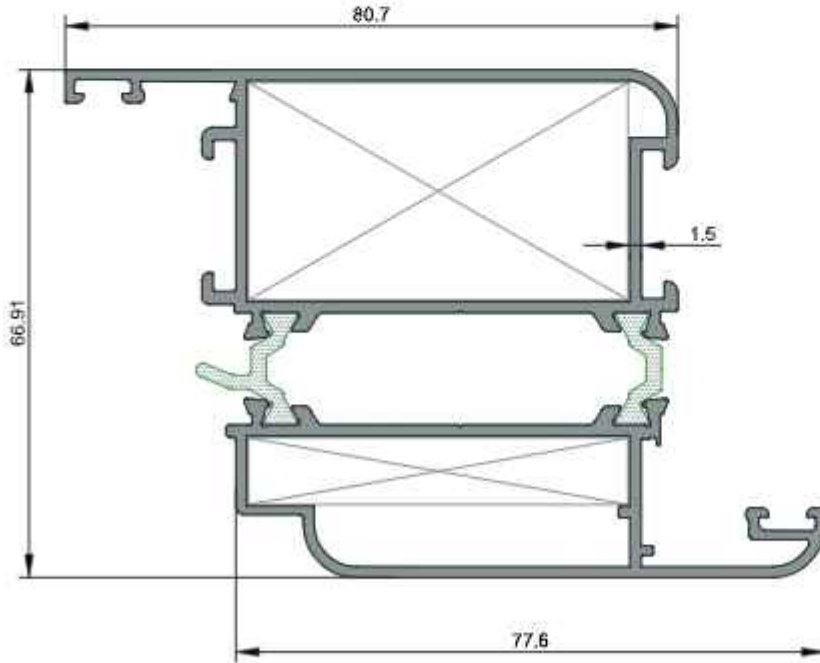

4722/4723
Oval Kapı Kanat Profili
1,855 kg/m
$J_x = 55,07 \text{ cm}^4$ $J_y = 26,19 \text{ cm}^4$

★ Yandaki profil birim ağırlıkları, bilgisayarla hesaplanmış teorik ağırlıklardır.

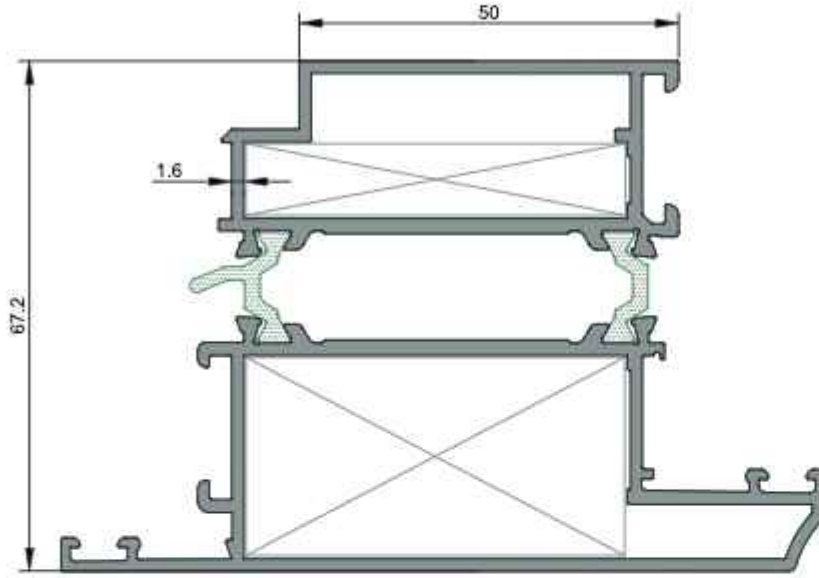

2663/64(1.6mm)
Kapı Kanat Profili(Dışa Açılır)
2,186 kg/m
Jx=53,73 cm ⁴ Jy=39,61 cm ⁴

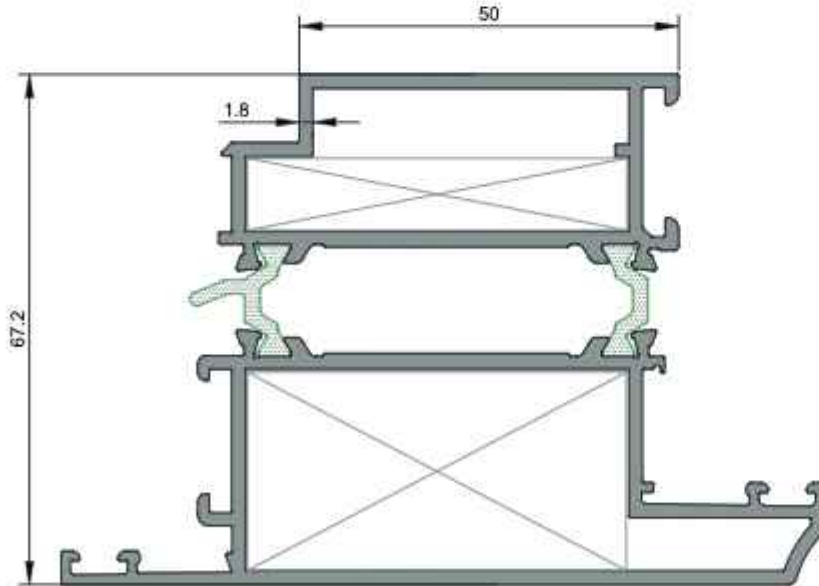

2663/64(1.8mm)
Kapı Kanat Profili(Dışa Açılır)
2,293 kg/m
Jx= 55,90 cm ⁴ Jy=42,58 cm ⁴

★ Yandaki profil birim ağırlıkları, bilgisayarda hesaplanmış teorik ağırlıklardır.

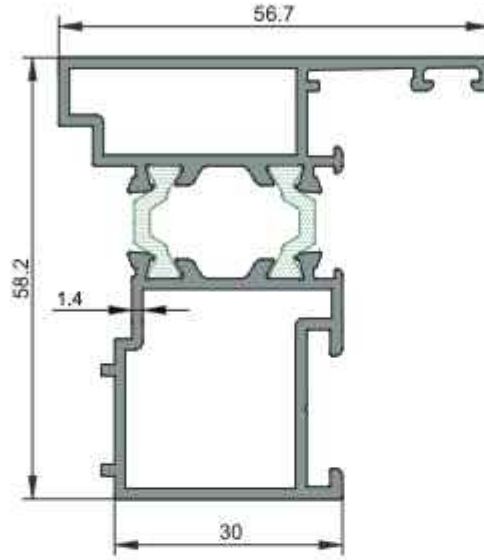

2659/60
Dışa Açılır Çift Kanat Adaptörü
1,229 kg/m
$J_x=16,40 \text{ cm}^4$ $J_y=7,86 \text{ cm}^4$

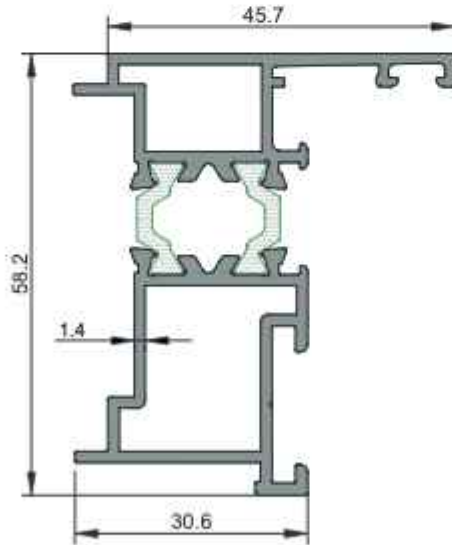

2655/56
Dışa Açılır Kapı Adaptörü
1,129 kg/m
$J_x=14,39 \text{ cm}^4$ $J_y=4,66 \text{ cm}^4$

★ Yandaki profil birim ağırlıkları, bilgisayarda hesaplanmış teorik ağırlıklardır.

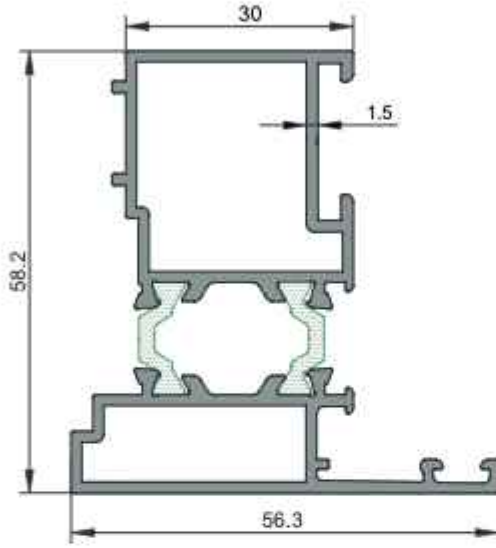

2815/16
İçe Açılır Çift Kanat Adaptörü
1,230 kg/m
$J_x=16,48 \text{ cm}^4$ $J_y=7,92 \text{ cm}^4$

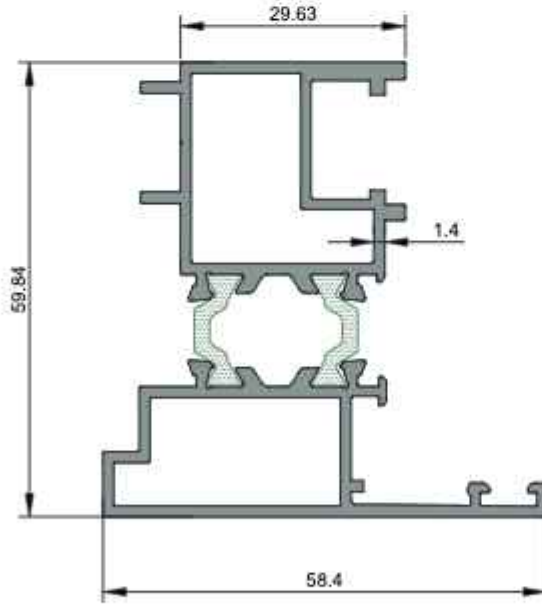

3556/57
PVC Kanallı Çift Kapı Adaptör Profili
1,315 kg/m
$J_x=19,01 \text{ cm}^4$ $J_y=7,60 \text{ cm}^4$

★ Yandaki profil birim ağırlıkları, bilgisayarda hesaplanmış teorik ağırlıklardır.

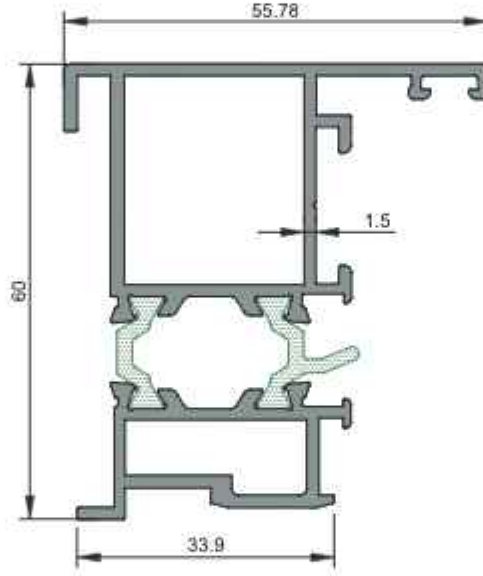

4899/4900
Pivot Kanat Adaptörü
1,354 kg/m
$J_x=20,78 \text{ cm}^4$ $J_y=8,86 \text{ cm}^4$

★ Yandaki profil birim ağırlıkları, bilgisayarda hesaplanmış teorik ağırlıklardır.

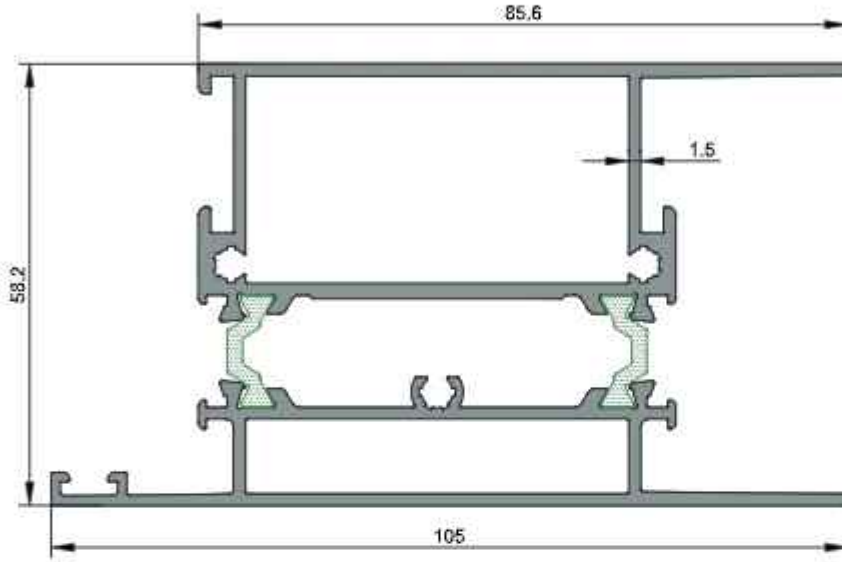

1909/10
Etek Profili
2,123 kg/m
Jx=54,89 cm ⁴ Jy=31,02 cm ⁴

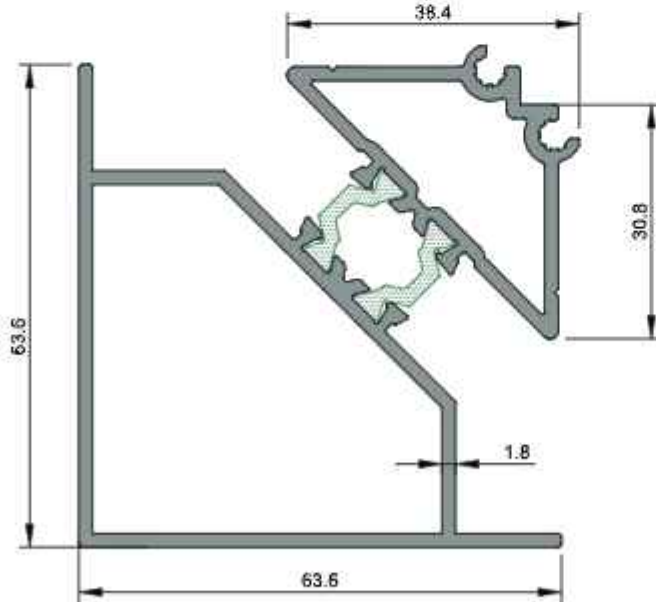

4733/34
Köşe Profili
1,823 kg/m
Jx=32,58 cm ⁴ Jy=24,95 cm ⁴

★ Yandaki profil birim ağırlıkları, bilgisayarda hesaplanmış teorik ağırlıklardır.

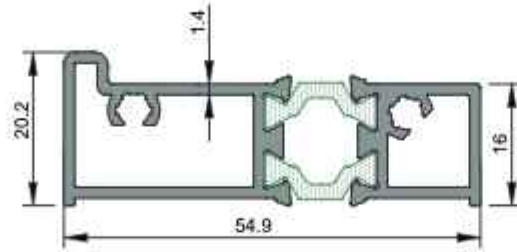

2935/36
Eşik Profili
0,813kg/m
Jx=8,69 cm ⁴ Jy=1,12 cm ⁴

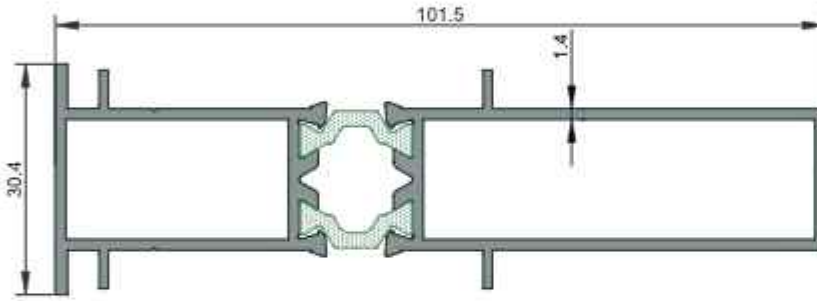

H3154/55
Ek Profil
1,269 kg/m
Jx=43,27 cm ⁴ Jy=3,20 cm ⁴

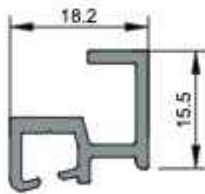

4120
Eşik-Kanat Adaptör Profili (İç)
0,245 kg/m

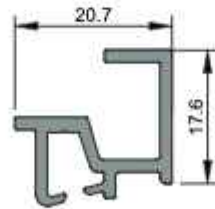

4121
Eşik-Kanat Adaptör Profili (Dış)
0,279 kg/m

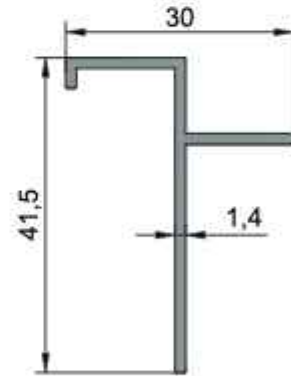

1404
Fugalı Te Bini
0,399 kg/m

★ Yandaki profil birim ağırlıkları, bilgisayarla hesaplanmış teorik ağırlıklardır.

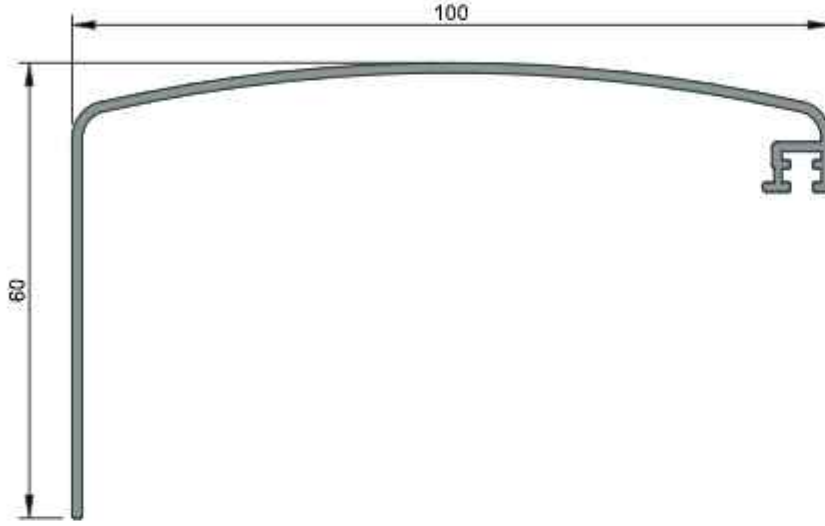

2260
Pervaz Profili
0,625 kg/m

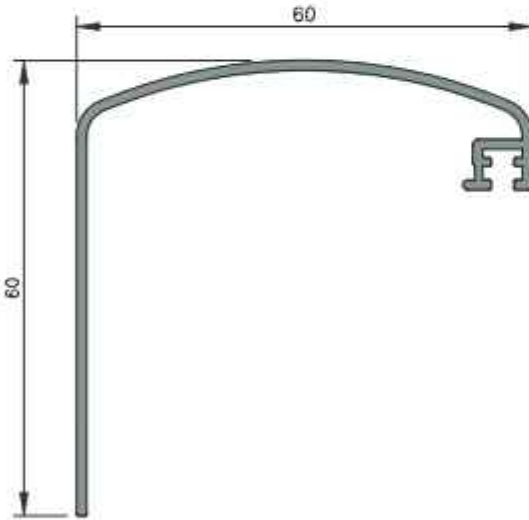

2259
Pervaz Profili
0,486 kg/m

★ Yandaki profil birim ağırlıkları, bilgisayarda hesaplanmış teorik ağırlıklardır.

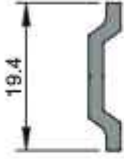

1210
İspanyollet Çubuğu
0,112 kg/m

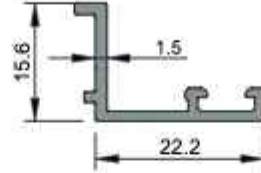

2660
Köşe Dönüş Adaptörü (Dış)
0,181 kg/m

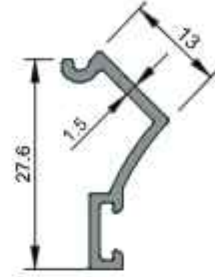

2667
Köşe Dönüş Adaptörü (İç)
0,179 kg/m

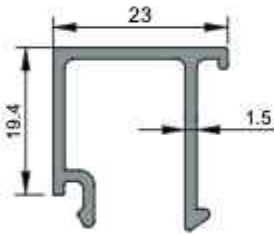

4124
Cam Çıtası
0,308 kg/m

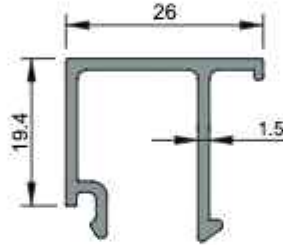

2668
Cam Çıtası
0,330 kg/m

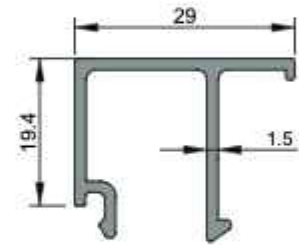

2657
Cam Çıtası
0,332 kg/m

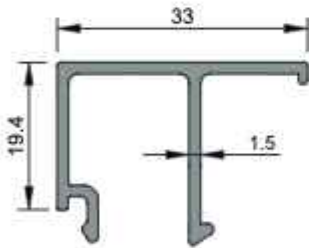

2914
Cam Çıtası
0,349 kg/m

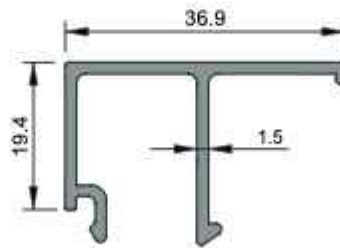

3136
Cam Çıtası
0,364 kg/m

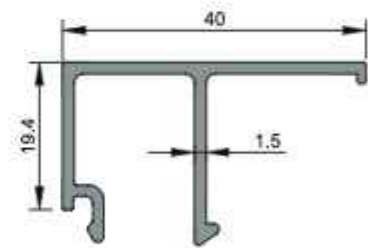

3183
Cam Çıtası
0,377 kg/m

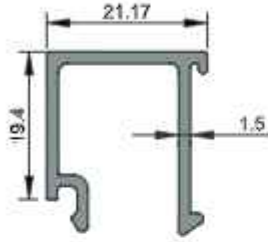

4756

Cam Çıtası
0,300 kg/m

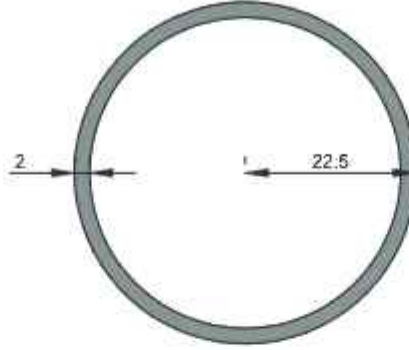

1416

45'lik Boru Profil
0,732 kg/m
 $J_x=6,25 \text{ cm}^4$ · $J_y=6,25 \text{ cm}^4$

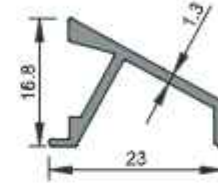

2181

Damlalık Profili
0,168 kg/m

★ Yandaki profil birim ağırlıkları, bilgisayarda hesaplanmış teorik ağırlıklardır.

ÇEKİRME TAKOZU KESİM ÖLÇÜLERİ

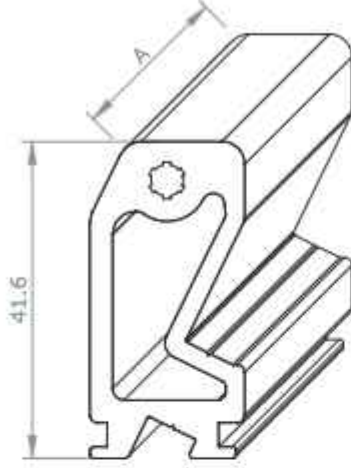

4125

Çekirme Takozu

1,099 kg/m

Aksesuar Kodu	Profil Kodu	Kesim Ölçüsü A(mm)
C4125 271	2651/52	27.1
C4125 271	2909/13	17.3

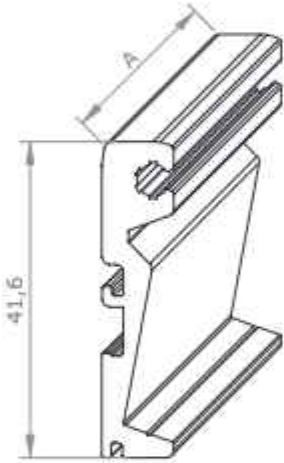

4133

Çekirme Takozu

0,566 kg/m

Aksesuar Kodu	Profil Kodu	Kesim Ölçüsü A(mm)
C4125 271	2651/52	27.1
C4125 271	2909/13	17.3

★ Yandaki profil birim ağırlıkları, bilgisayarda hesaplanmış teorik ağırlıklardır.

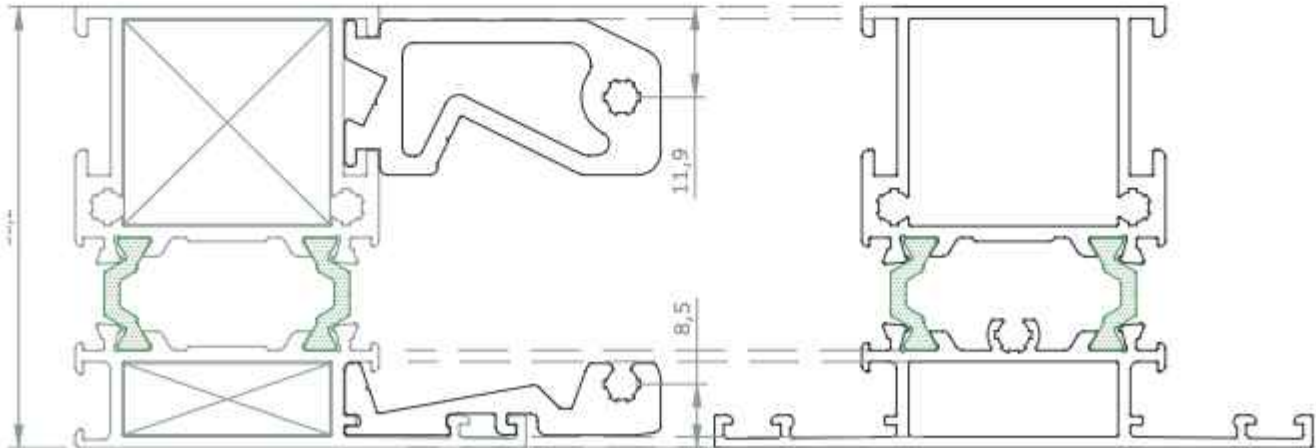

ORTA KAYIT KERTME DETAYI

★ Yandaki profil birim ağırlıkları, bilgisayarla hesaplanmış teorik ağırlıklardır.

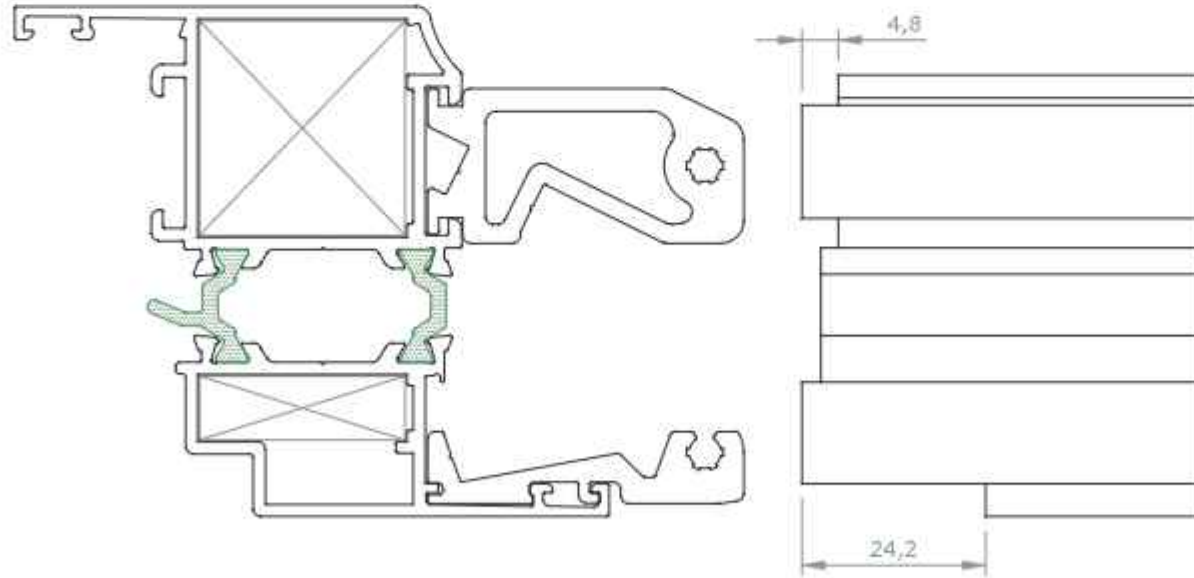
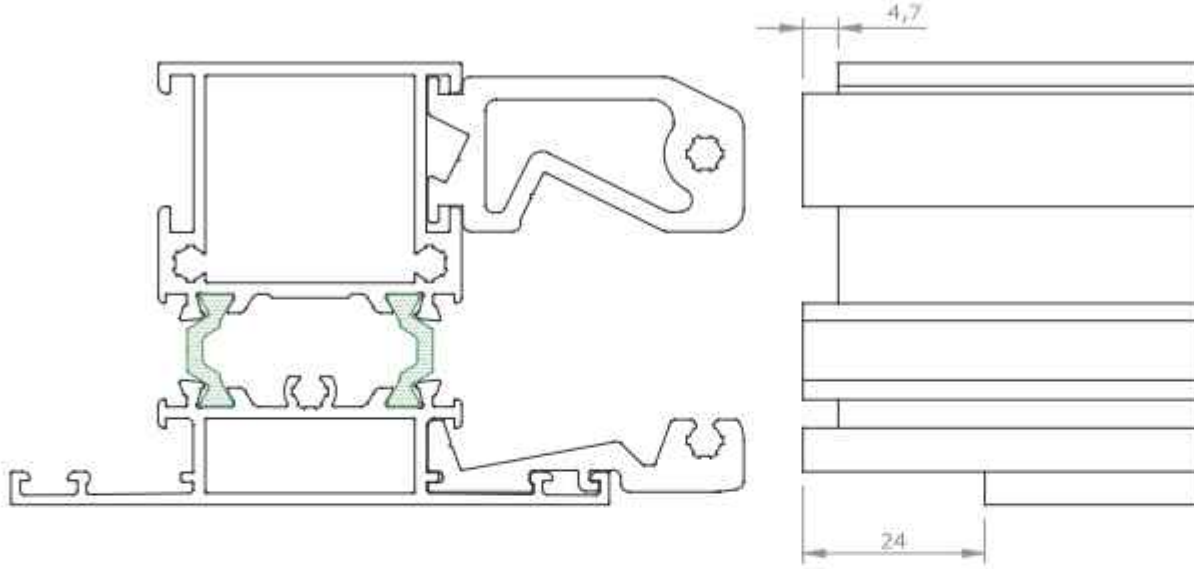

KÖŞE TAKOZU KESİM ÖLÇÜLERİ

3545

Köşe Takozu

4,616 kg/m

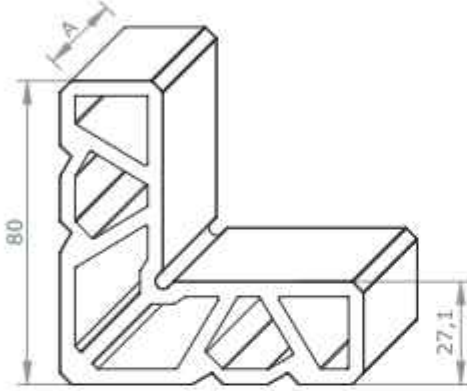

Aksesuar Kodu	Profil Kodu	Kesim Ölçüsü A(mm)
K3545 271	2650/2651-1,4	27.1
K3545 096	2650/2651-1,4	9.6
K3545 268	2650/2651-1,6	26.8
K3545 094	2650/2651-1,6	9.4
K3545 263	2650/2651-1,8	26.3
K3545 088	2650/2651-1,8	8.8
K3545 271	2651/2652-1,4	27.1
K3545 096	2651/2652-1,4	9.6
K3545 268	2651/2652-1,6	26.8
K3545 094	2651/2652-1,6	9.4
K3545 263	2651/2652-1,8	26.3
K3545 088	2651/2652-1,8	8.8
K3545 287	2653/2654-1,4	28.7
K3545 088	2653/2654-1,4	8.8
K3545 283	2653/2654-1,6	28.3
K3545 083	2653/2654-1,6	8.3
K3545 279	2653/2654-1,8	27.9
K3545 080	2653/2654-1,8	8.0
K3545 263	4452/4453-1,6	26.3
K3545 088	4452/4453-1,6	8.8
K3545 263	4452/4453-1,8	26.3
K3545 088	4452/4453-1,8	8.8
K3545 268	4718/4719	26.8
K3545 231	4718/4719	23.1
K3545 268	2651/4513	26.8
K3545 231	2651/4513	23.1
K3545 287	4720/4721	28.7
K3545 087	4720/4721	8.7
K3545 088	2654	8.8

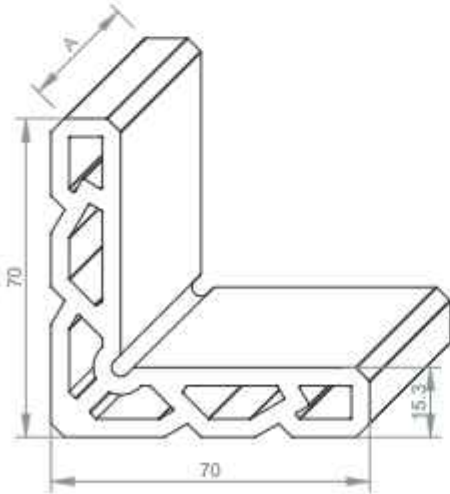

2929

Köşe Takozu

3,341 kg/m

Aksesuar Kodu	Profil Kodu	Kesim Ölçüsü A(mm)
K2929 297	3478/3479	29.7
K2929 080	3478/3479	8.0

★ Yandaki profil birim ağırlıkları, bilgisayarda hesaplanmış teorik ağırlıklardır.

KÖŞE TAKOZU KESİM ÖLÇÜLERİ

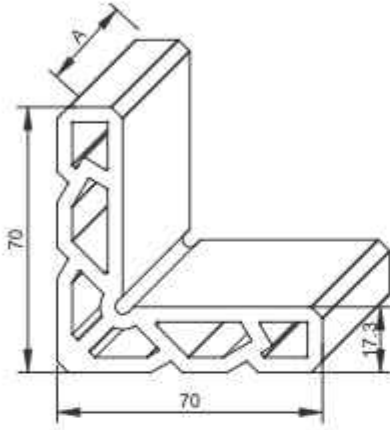

2917
Köşe Takozu
3,469 kg/m

Aksesuar Kodu	Profil Kodu	Kesim Ölçüsü A(mm)
K2917 268	2909/2910	26.8
K2917 094	2909/2910	9.4
K2917 268	2909/2913	26.8
K2917 094	2909/2913	9.4
K2917 283	2911/2912	28.3
K2917 083	2911/2912	8.3
K2917 377	2932	37.7

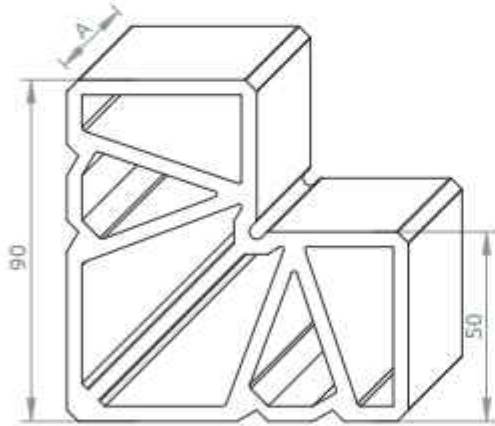

3546
Köşe Takozu
6,304 kg/m

Aksesuar Kodu	Profil Kodu	Kesim Ölçüsü A(mm)
K3546 263	2663/2664-1,6	26.3
K3546 096	2663/2664-1,6	9.6
K3546 261	2663/2664-1,8	26.1
K3546 094	2663/2664-1,8	9.4
K3546 283	2661/2662-1,6	28.3
K3546 083	2661/2662-1,6	8.3
K3546 284	2661/2662-1,8	28.4
K3546 085	2661/2662-1,8	8.5
K3546 297	3483/3484	29.7
K3546 080	3483/3484	8.0
K3546 268	2933/2934	26.8
K3546 080	2933/2934	8.0
K3546 377	4722/4723	37.7
K3546 088	4722/4723	8.8

★ Yandaki profil birim ağırlıkları, bilgisayarda hesaplanmış teorik ağırlıklardır.

CAMLAMA SEÇENEK TABLOSU

ÖLÇEK:1/1

★ Yandaki profil birim ağırlıkları, bilgisayarla hesaplanmış teorik ağırlıklardır.

	Cam Kalınlığı - Cam Çıtası Yüksekliği	Fitil Kodu	Profil
6	40	HL 07	3183
7		HL 04	
8		HL 31	
9	36.9	HL 07	3136
10		HL 04	
11		HL 31	
13	33	HL 07	2914
14		HL 04	
15		HL 31	
17	29	HL 07	2657
18		HL 04	
19		HL 31	
20	26	HL 07	2668
21		HL 04	
22		HL 31	
23	23	HL 07	4124
24		HL 04	
25		HL 31	

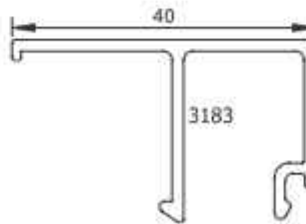
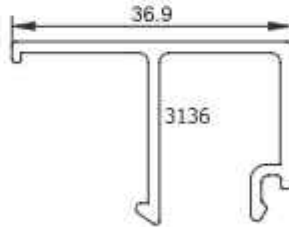
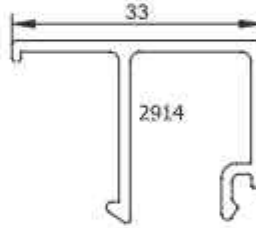
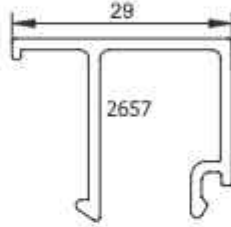
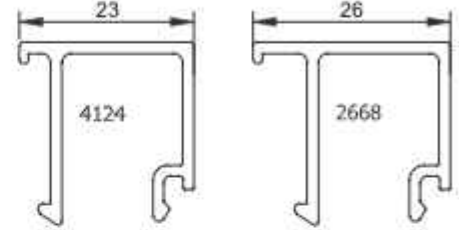

CAMLAMA SEÇENEK TABLOSU

ÖLÇEK:1/1

★ Yandaki profil birim ağırlıkları, bilgisayarda hesaplanmış teorik ağırlıklardır.

	Cam Kalınlığı - Cam Çıtası Yüksekliği	Fitel Kodu	Profil
5	40	HL 07	3183
7		HL 04	
8		HL 31	
9	36.9	HL 07	3136
10		HL 04	
11		HL 31	
13	33	HL 07	2914
14		HL 04	
15		HL 31	
17	29	HL 07	2657
18		HL 04	
19		HL 31	
20	26	HL 07	2668
21		HL 04	
22		HL 31	
23	23	HL 07	4124
24		HL 04	
25		HL 31	

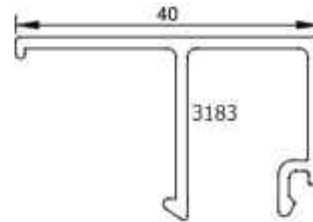
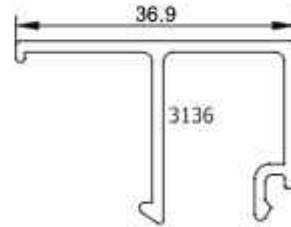
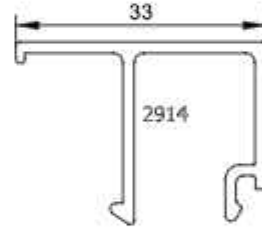
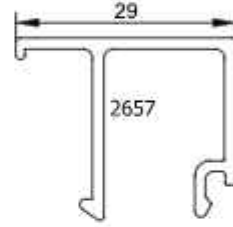
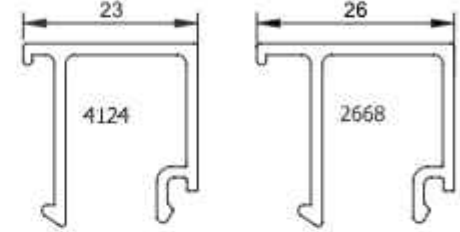

CAMLAMA SEÇENEK TABLOSU

ÖLÇEK:1/1

★ Yandaki profil birim ağırlıkları, bilgisayararda hesaplanmış teorik ağırlıklardır.

Cam Kalınlığı - Cam Çıtası Yüksekliği	Fital Kodu	Profil
36.9	HL 07	3136
	HL 04	
	HL 31	
33	HL 07	2914
	HL 04	
29	HL 07	2657
	HL 04	
	HL 31	
26	HL 07	2668
	HL 04	
	HL 31	
23	HL 04	4124
	HL 31	
21.2	HL 07	4756
	HL 04	
	HL 31	

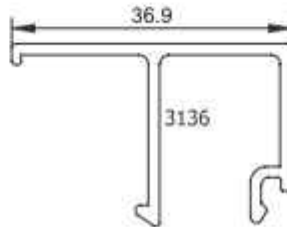
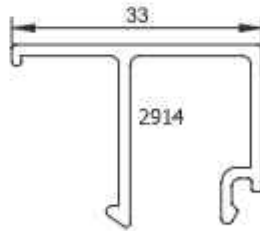
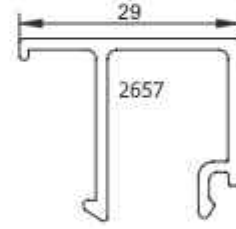
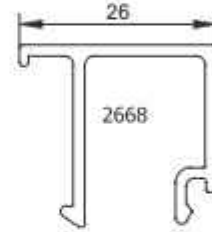
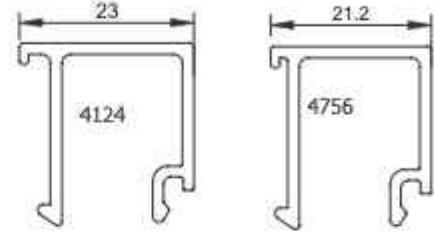

PENCERE UYGULAMA TİPLERİ

★ Yandaki profil birim ağırlıkları, bilgisayarda hesaplanmış teorik ağırlıklardır.

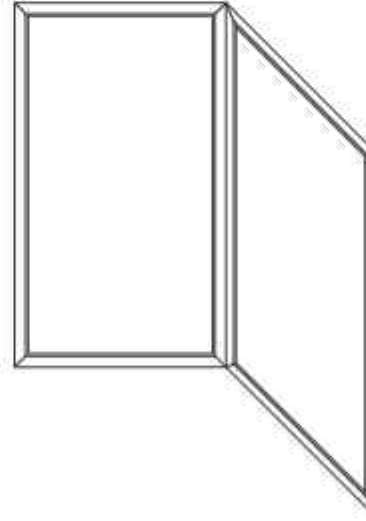
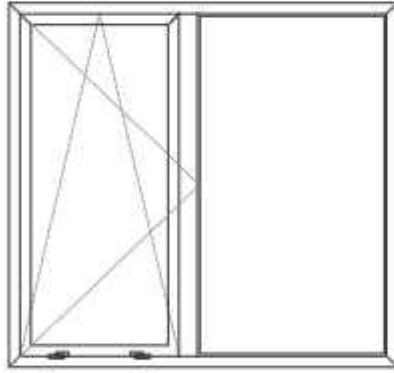
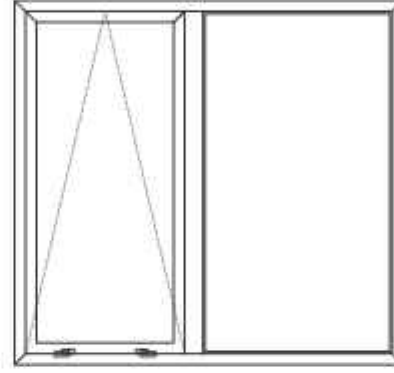
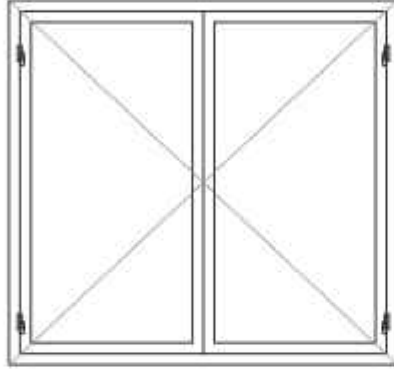

DETAY-1a
ÖLÇEK:1/1

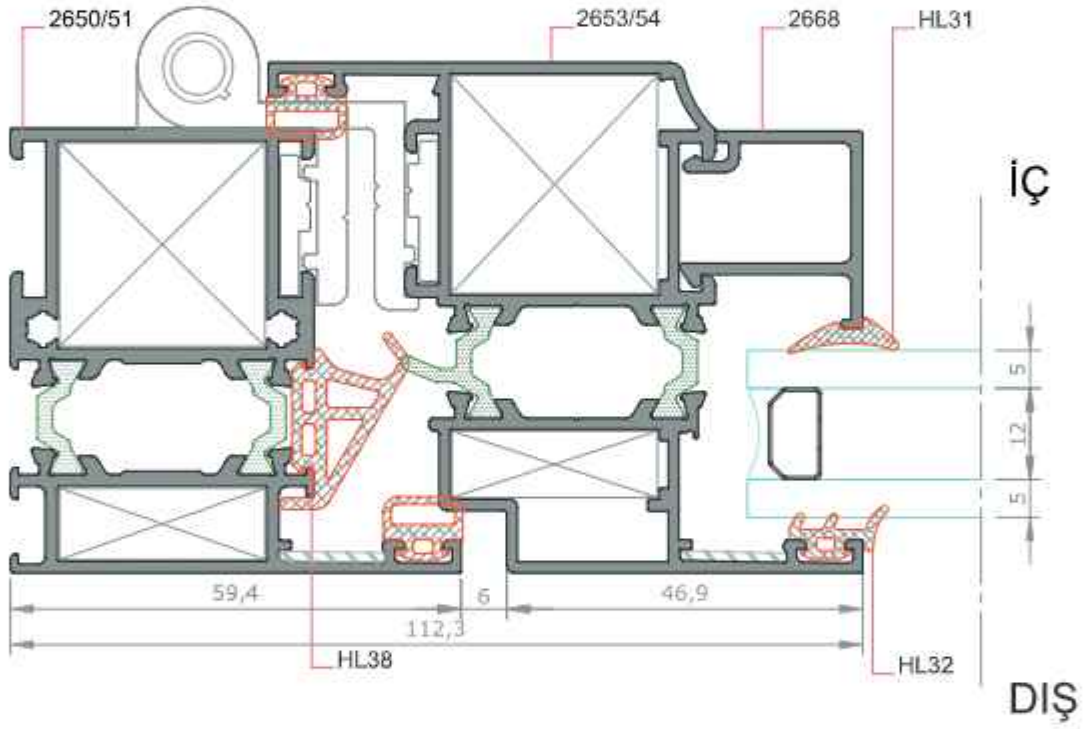
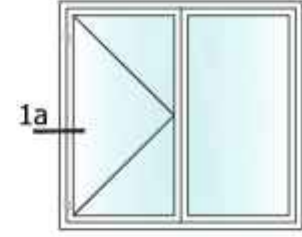

★ Yandaki profil birim ağırlıkları, bilgisayarla hesaplanmış teorik ağırlıklardır.

DETAY-1b
ÖLÇEK:1/1

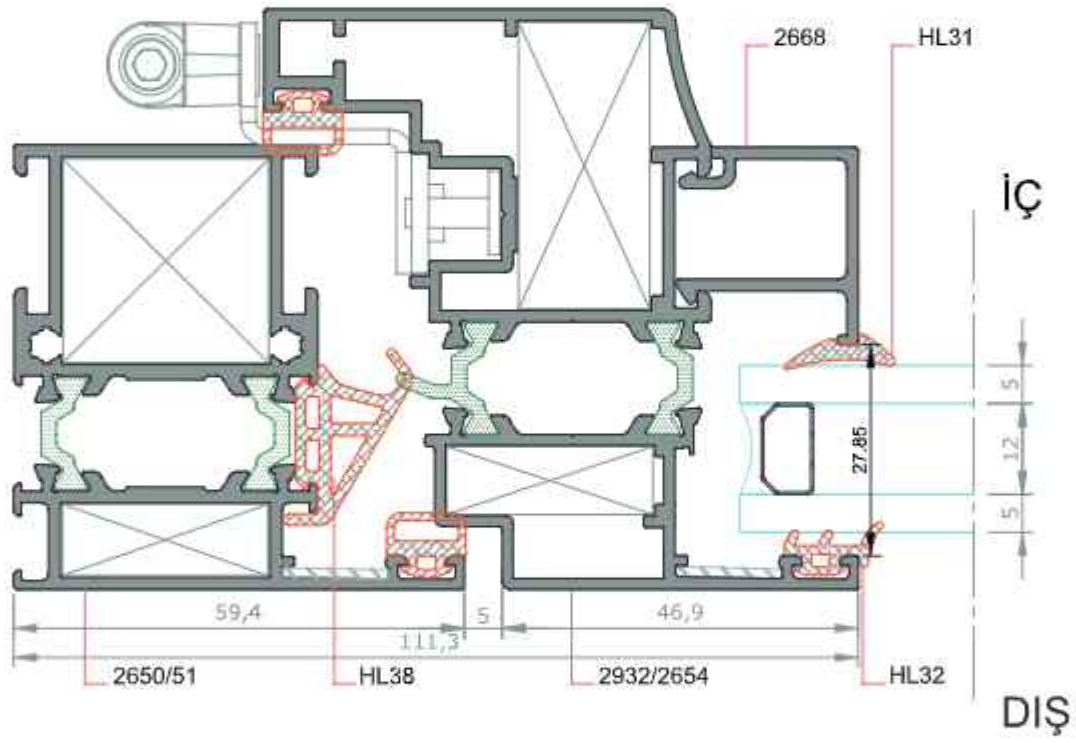
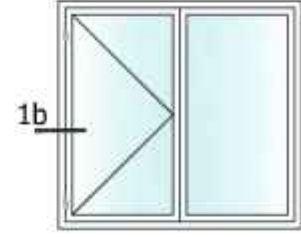

★ Yandaki profil birim ağırlıkları, bilgisayarla hesaplanmış teorik ağırlıklardır.

DETAY-1c

ÖLÇEK: ÖLÇEKSİZ

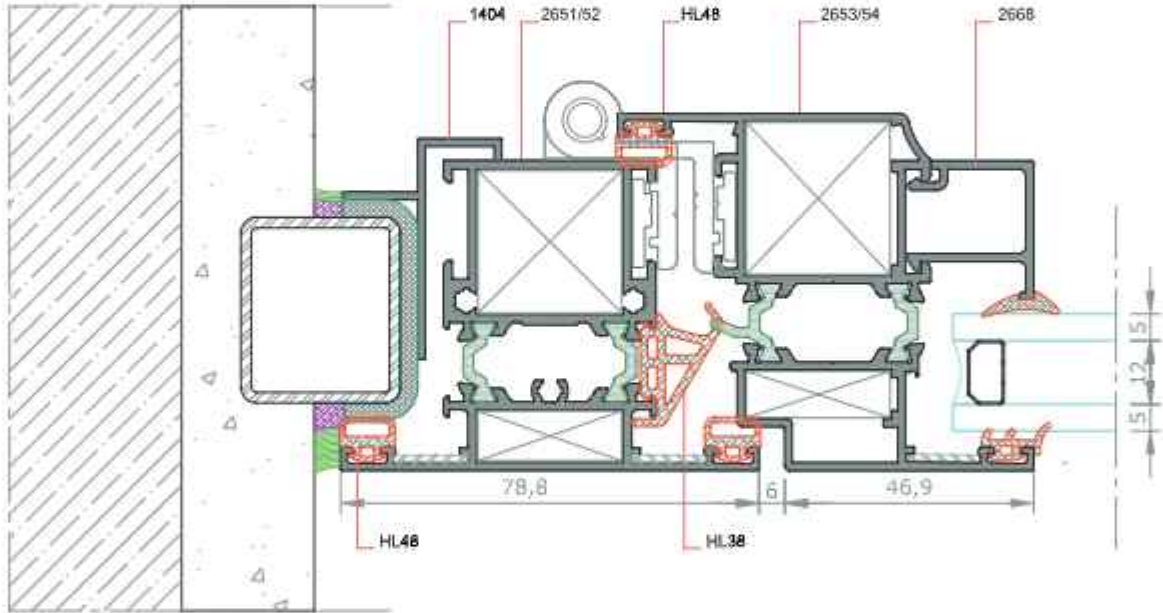
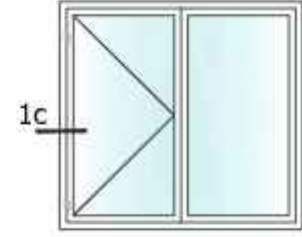

★ Yandaki profil birim ağırlıkları, bilgisayarla hesaplanmış teorik ağırlıklardır.

DETAY-1d
ÖLÇEK:1/1

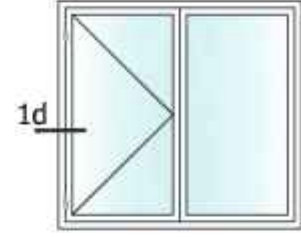

★ Yandaki profil ağırlıkları, bilgisayarla hesaplanmış teorik ağırlıklardır.

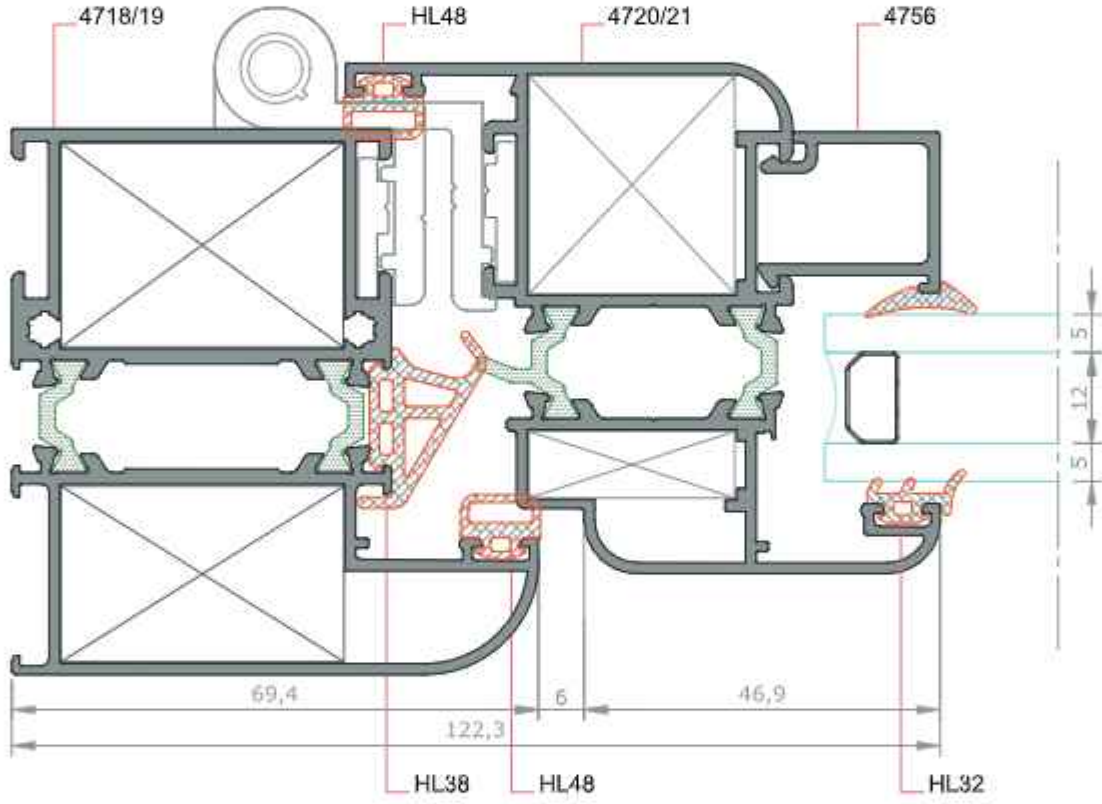

DETAY-1e

ÖLÇEK: ÖLÇEKSİZ

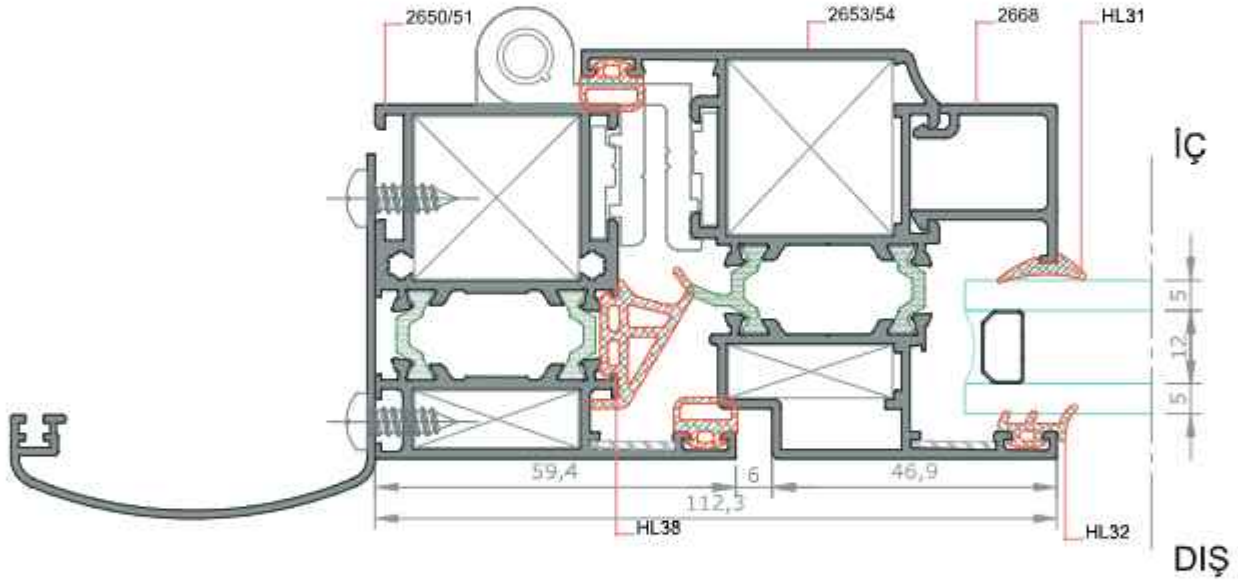
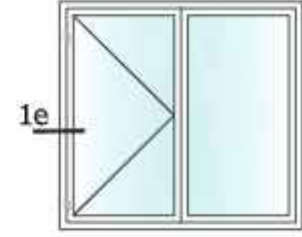

★ Yandaki profil birim ağırlıkları, bilgisayarla hesaplanmış teorik ağırlıklardır.

DETAY-2
ÖLÇEK:1/1

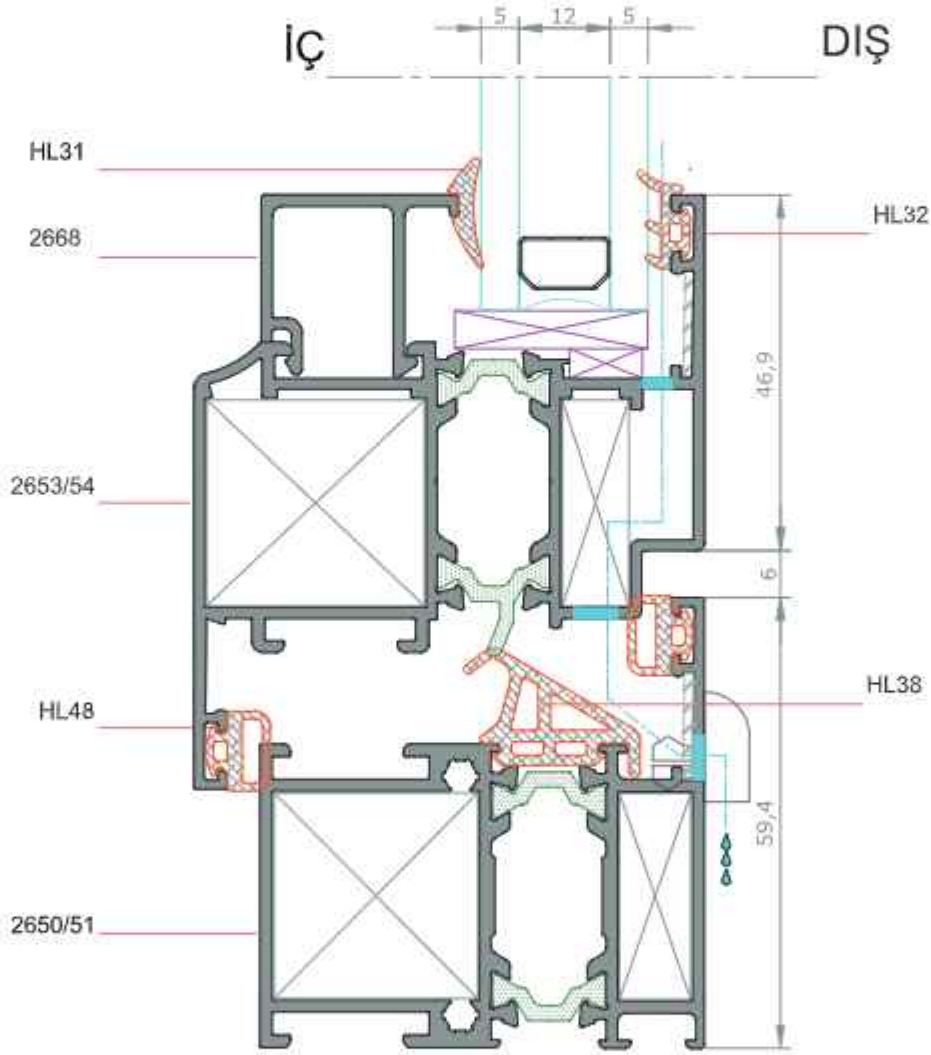
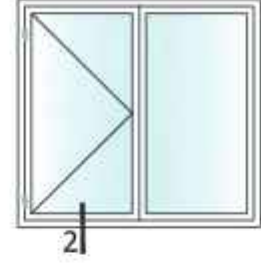

★ Yandaki profil ağırlıkları, bilgisayarla hesaplanmış teorik ağırlıklardır.

DETAY-3
ÖLÇEK:1/1

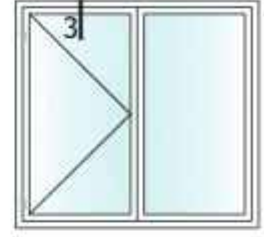

★ Yandaki profil birim ağırlıkları, bilgisayarla hesaplanmış teorik ağırlıklardır.

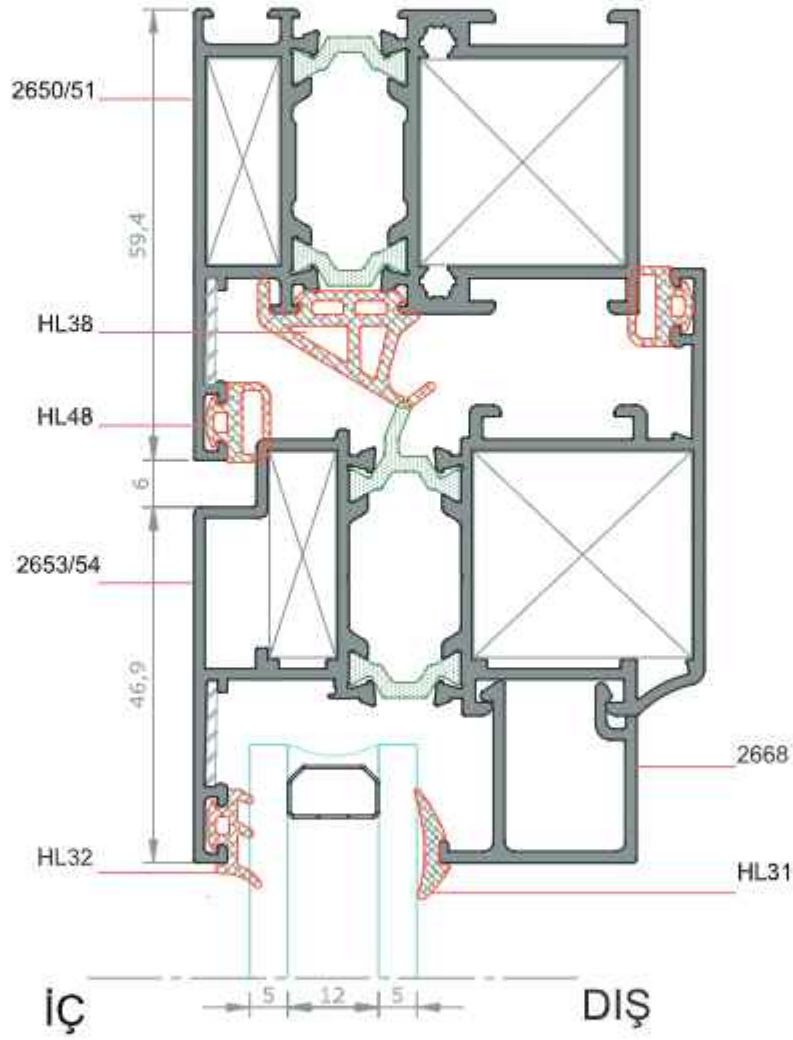

DETAY- 4
ÖLÇEK:1/1

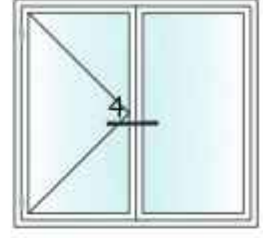

★ Yandaki profil birim ağırlıkları, bilgisayarda hesaplanmış teorik ağırlıklardır.

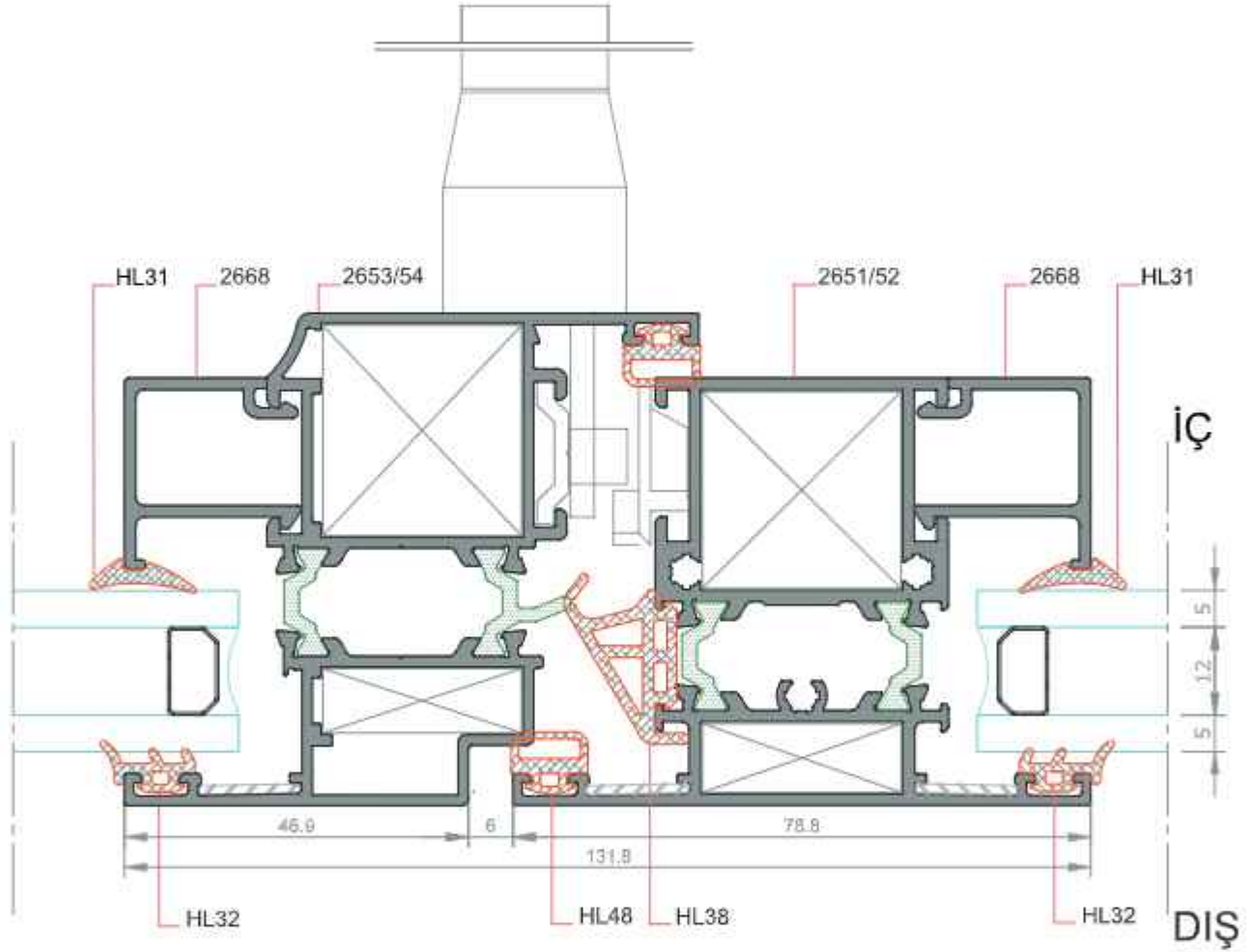

DETAY- 4a
ÖLÇEK:1/1

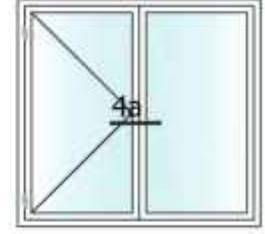

★ Yandaki profil birim ağırlıkları, bilgisayarda hesaplanmış teorik ağırlıklardır.

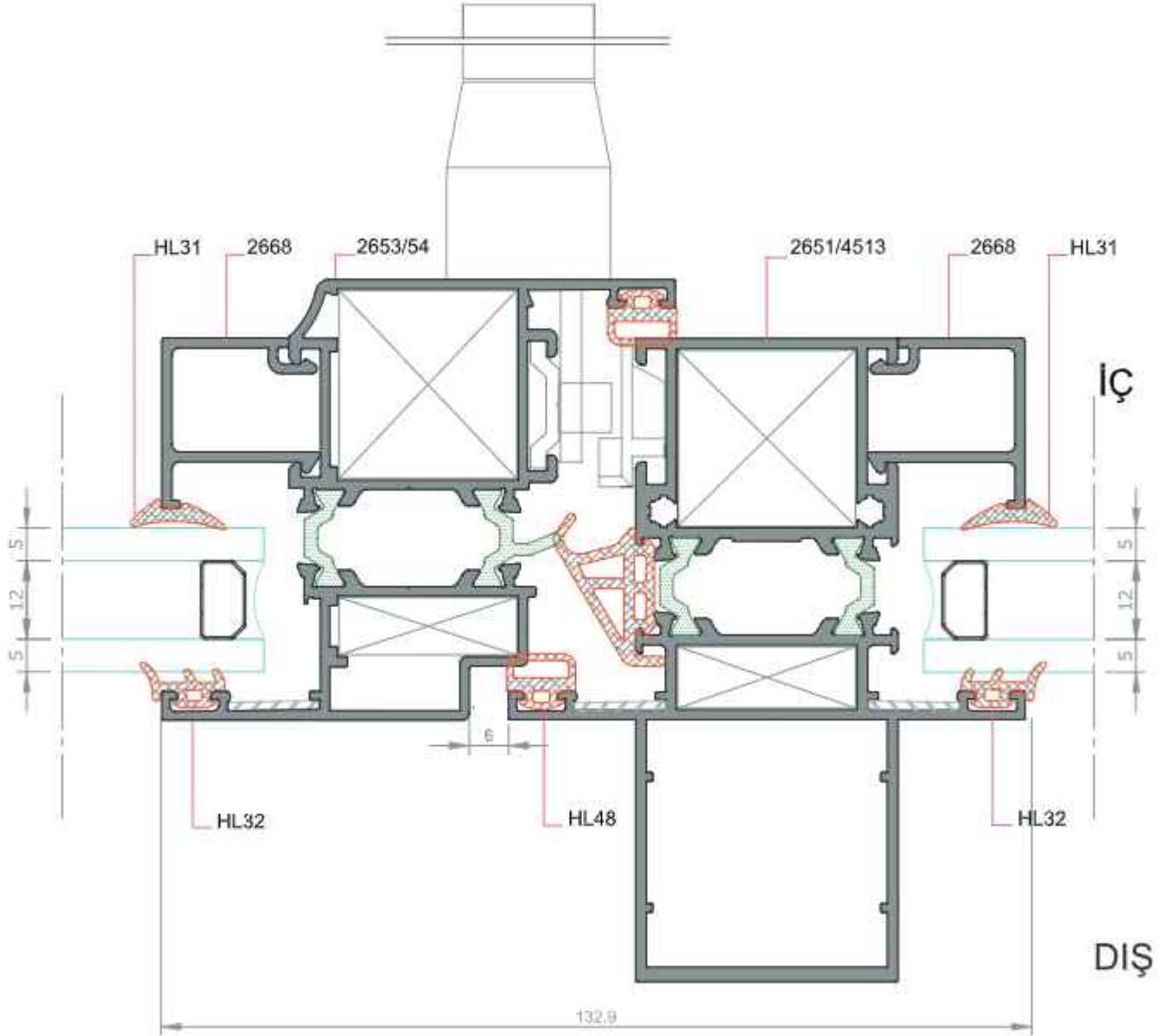

DETAY- 5
ÖLÇEK:1/1

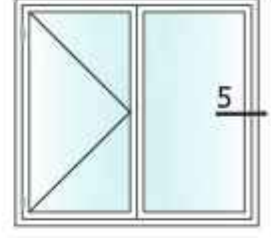

★ Yandaki profil birim ağırlıkları, bilgisayarda hesaplanmış teorik ağırlıklardır.

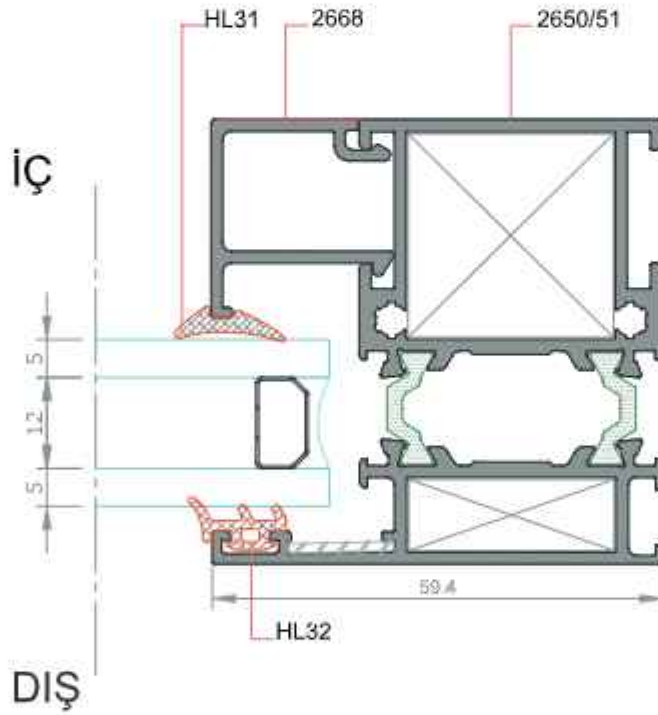

DETAY-1
ÖLÇEK:1/1

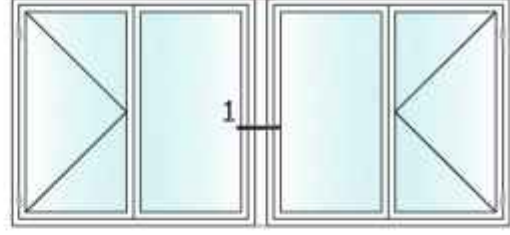

★ Yandaki profil birim ağırlıkları, bilgisayarda hesaplanmış teorik ağırlıklardır.

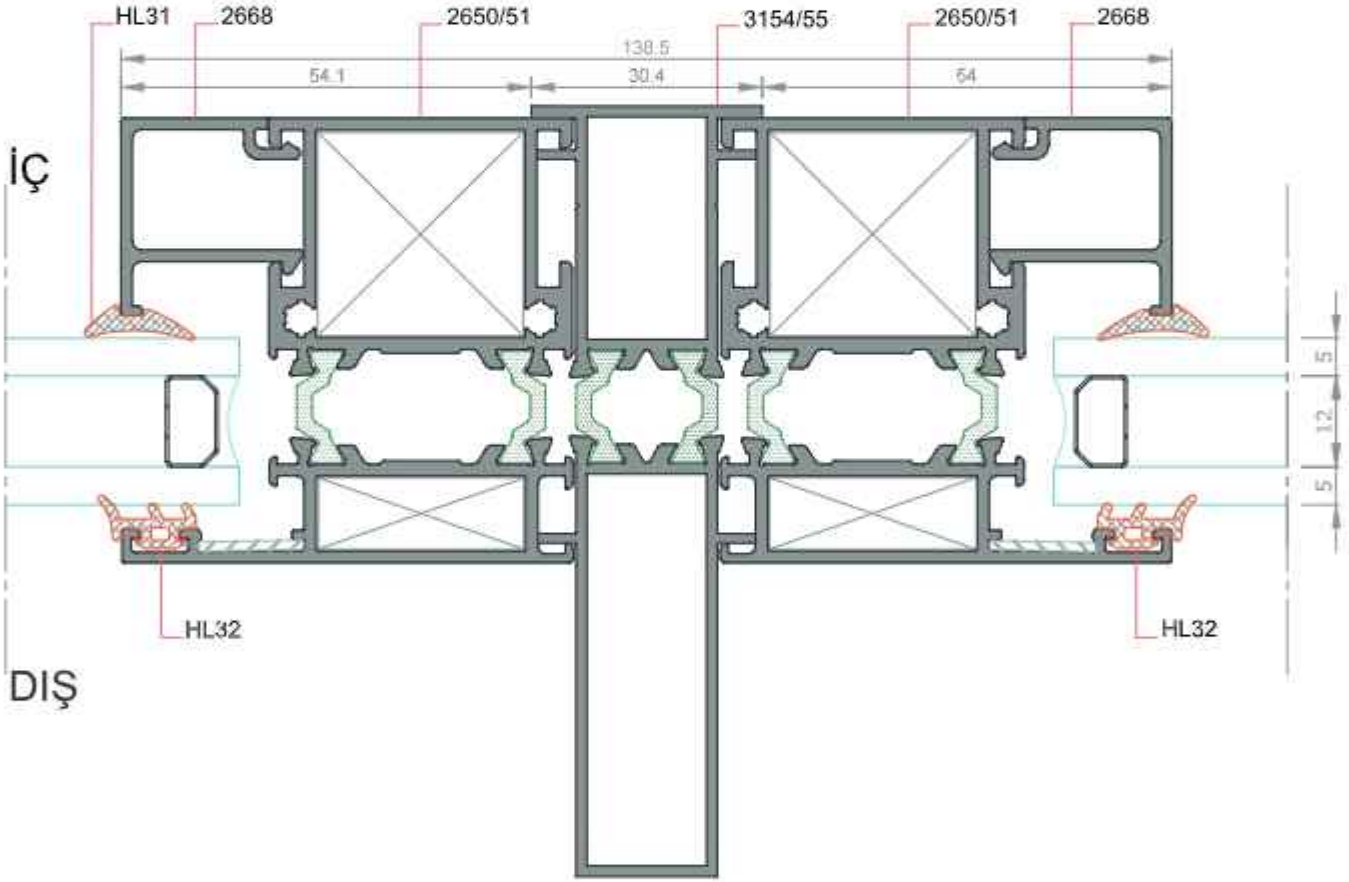

DETAY- 1a

ÖLÇEK:1/1

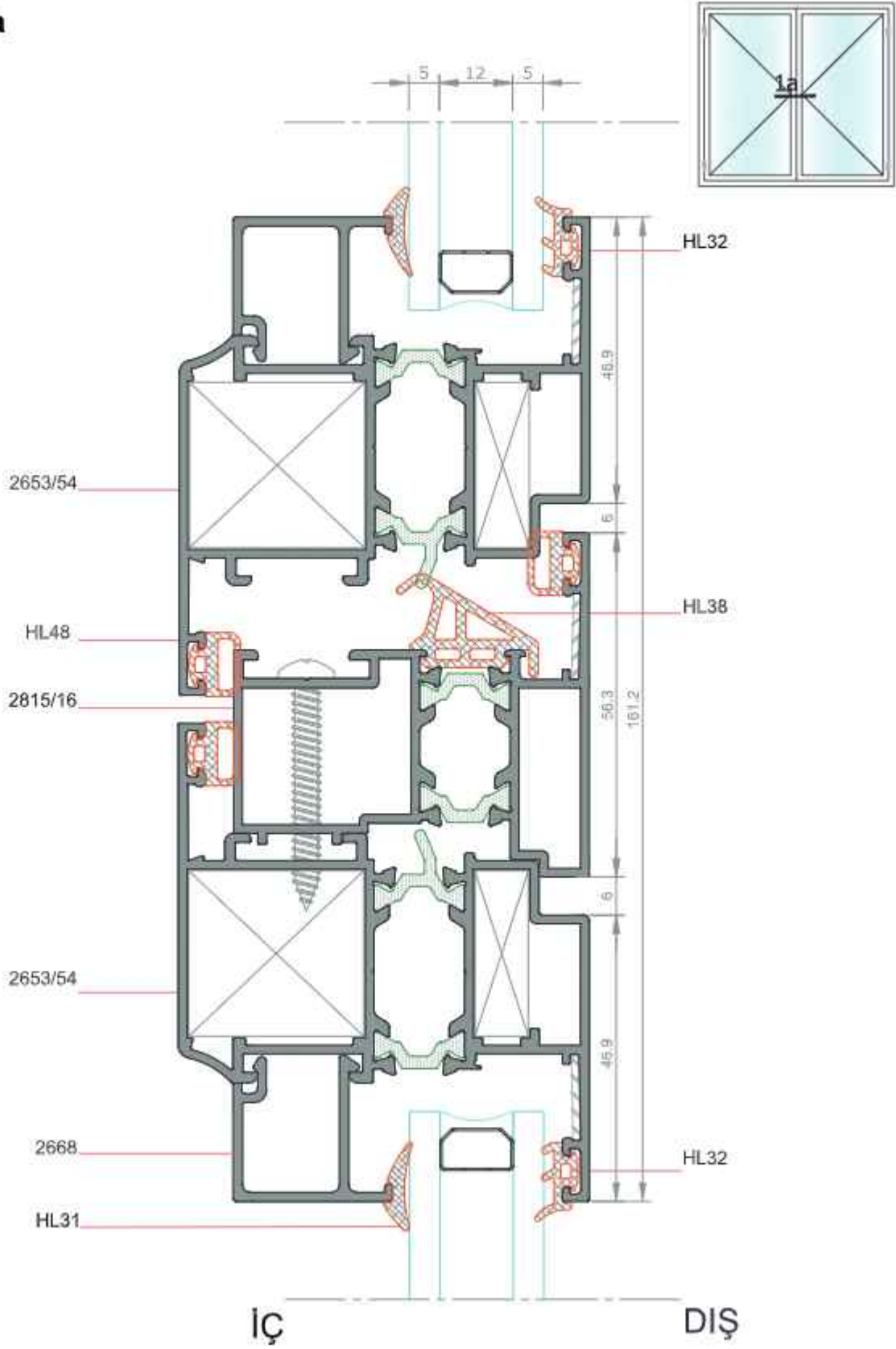

★ Yandaki profil birim ağırlıkları, bilgisayarda hesaplanmış teorik ağırlıklardır.

DETAY- 1b
ÖLÇEK:1/1

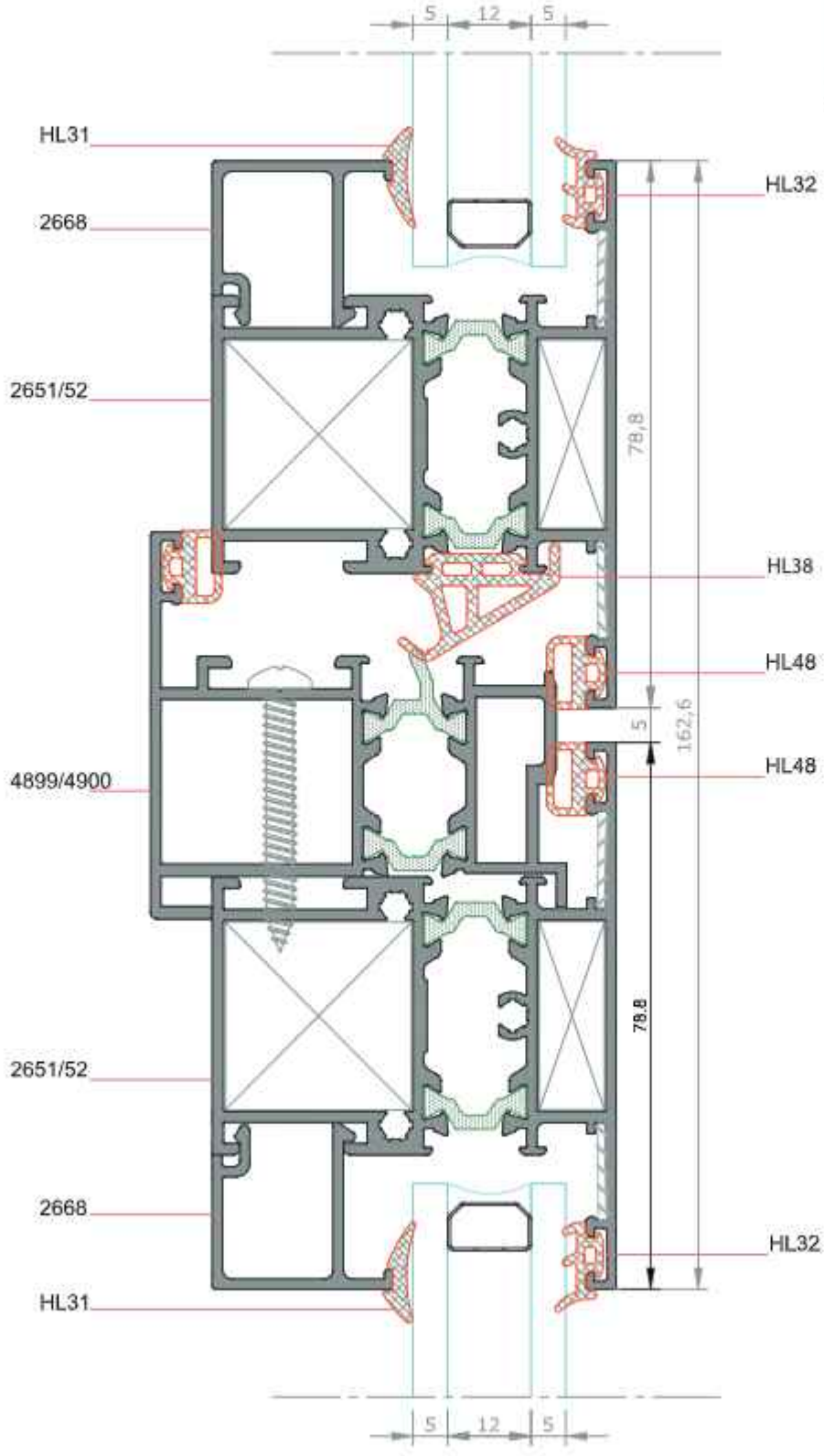
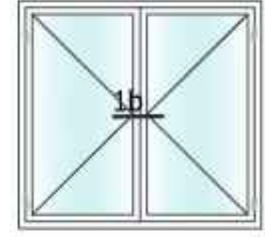

★ Yandaki profil birim ağırlıkları, bilgisayarla hesaplanmış teorik ağırlıklardır.

DETAY- 1c
ÖLÇEK 1/1

★ Yandaki profil birim ağırlıkları, bilgisayarla hesaplanmış teorik ağırlıklardır.

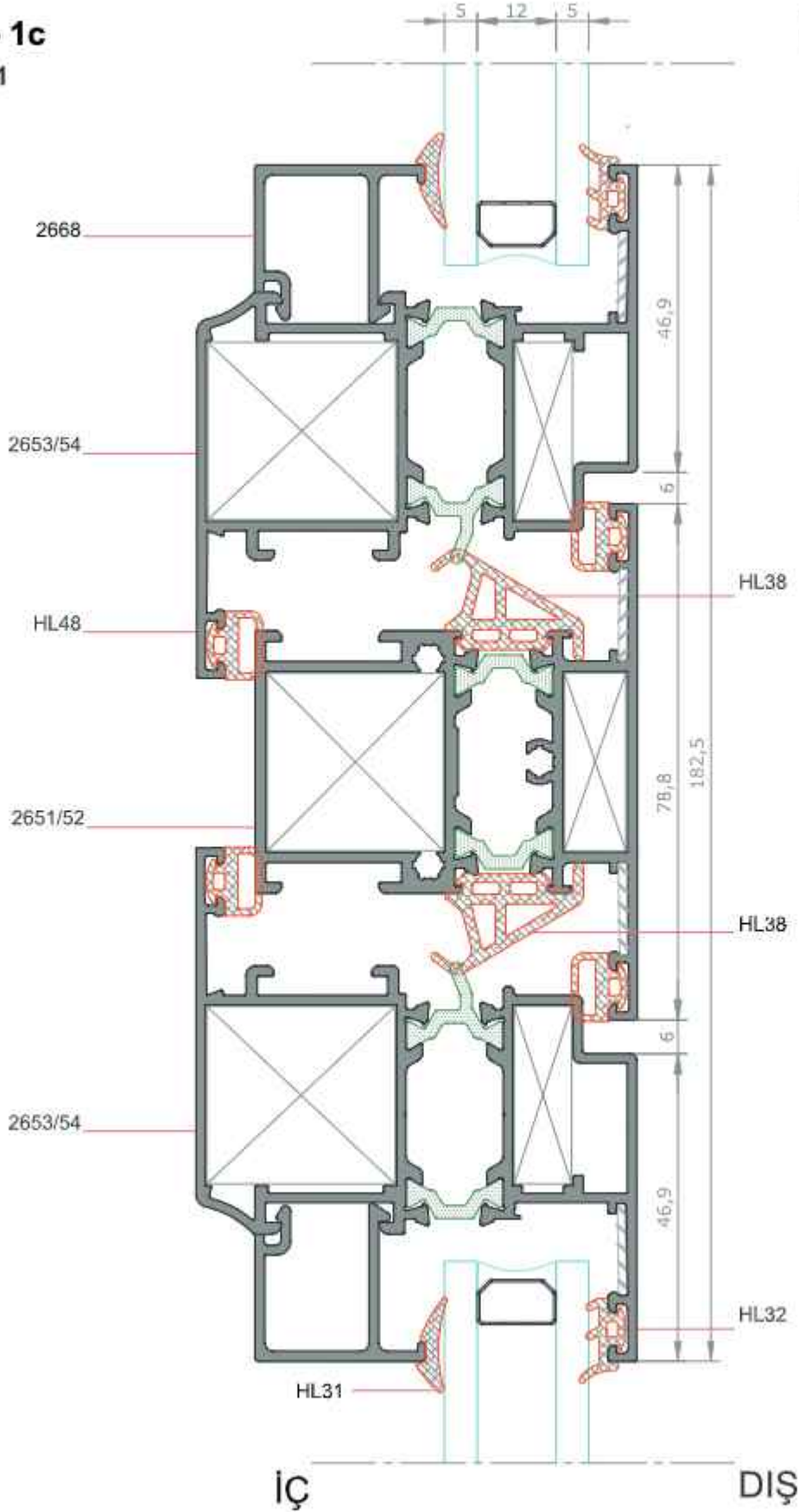

DETAY- 1
ÖLÇEK:1/1

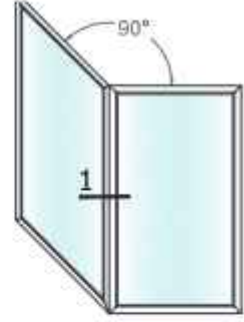

★ Yandaki profil birim ağırlıkları, bilgisayarla hesaplanmış teorik ağırlıklardır.

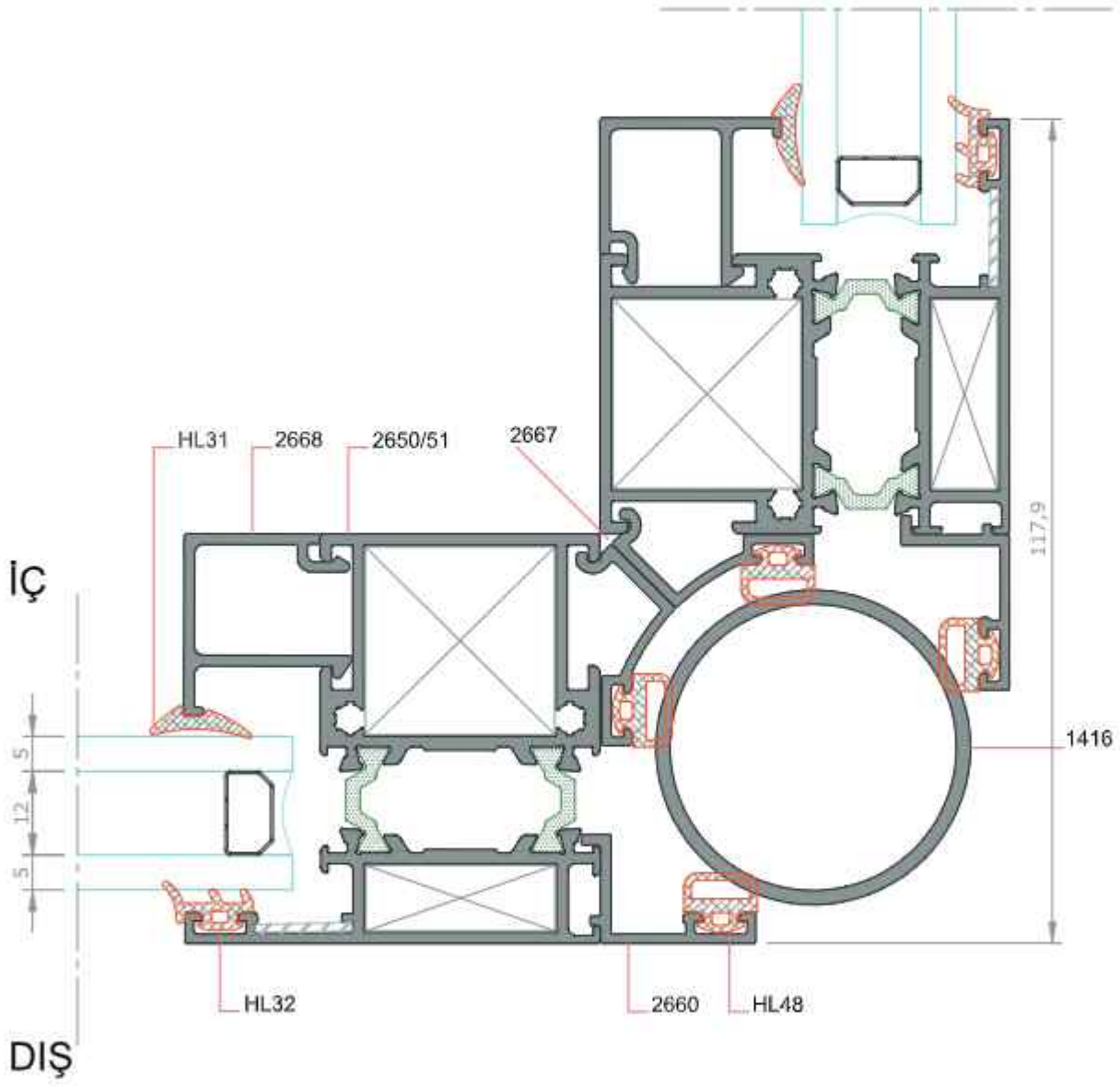

DETAY- 1
ÖLÇEK:1/1

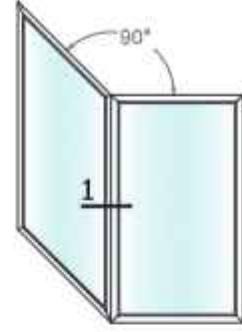

★ Yandaki profil birim ağırlıkları, bilgisayarla hesaplanmış teorik ağırlıklardır.

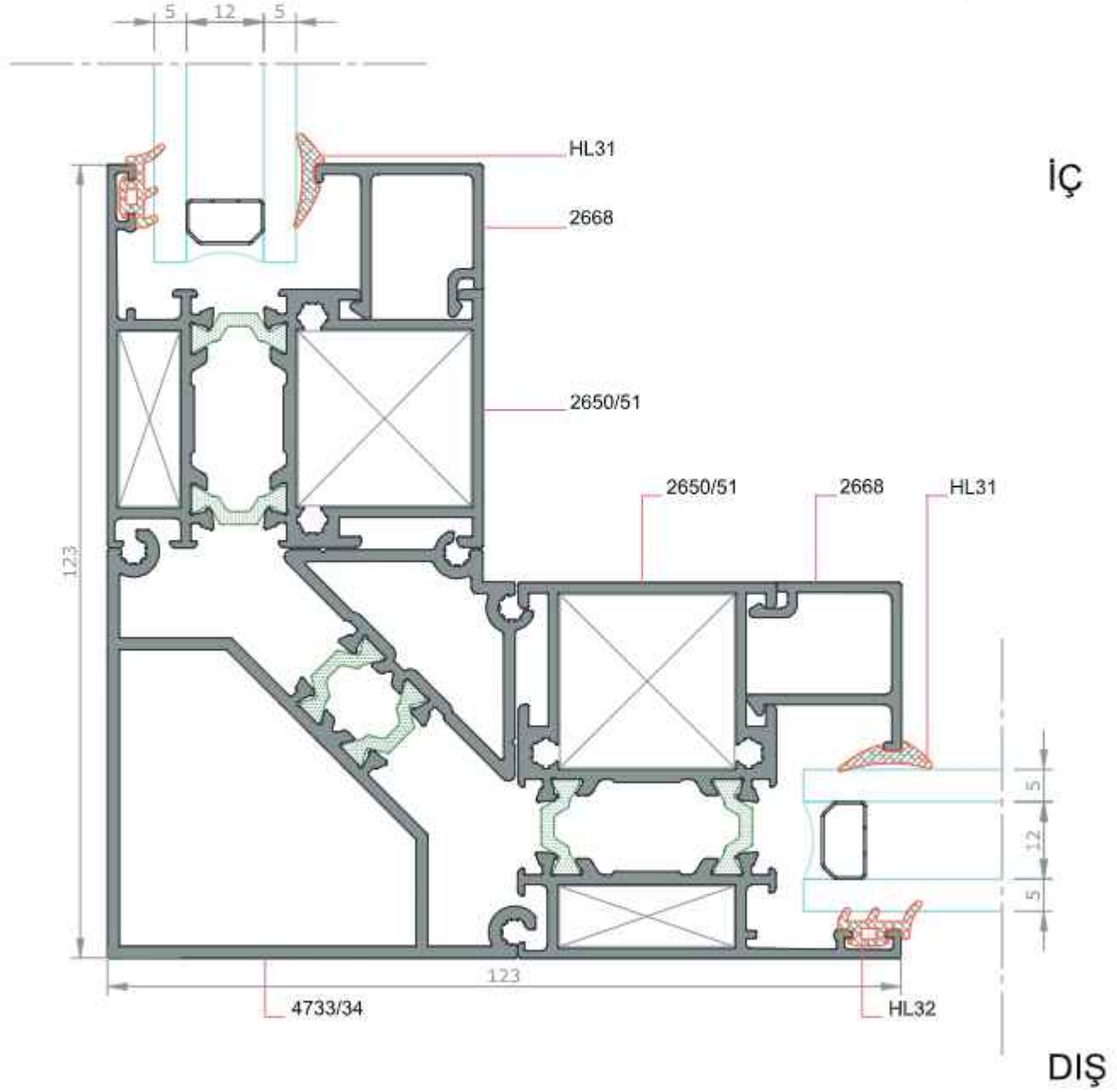

KAPI UYGULAMA TİPLERİ

★ Yandaki profil birim ağırlıkları, bilgisayarla hesaplanmış teorik ağırlıklardır.

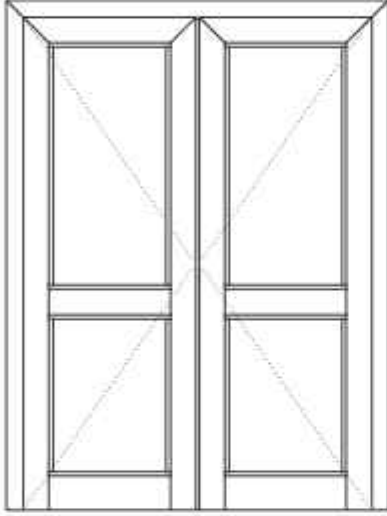

İçe Açılır Kapi

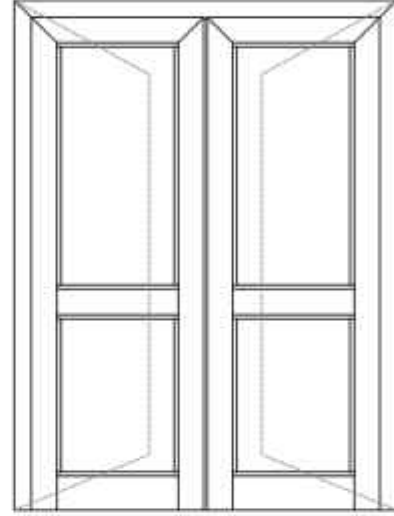

Dışa Açılır Kapi

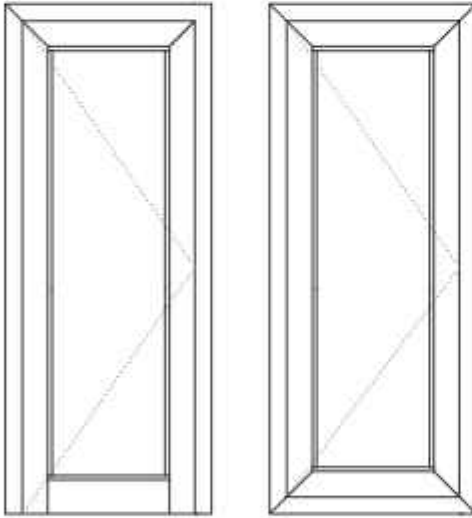

İçe Açılır Kapi

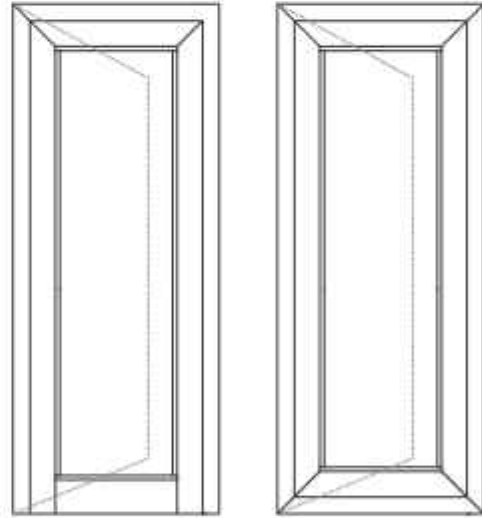

Dışa Açılır Kapi

DETAY- 1a
ÖLÇEK:1/1

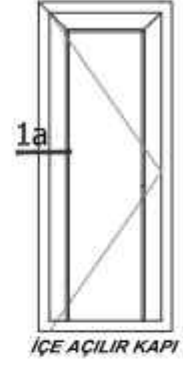

★ Yandaki profil birim ağırlıkları, bilgisayarda hesaplanmış teorik ağırlıklardır.

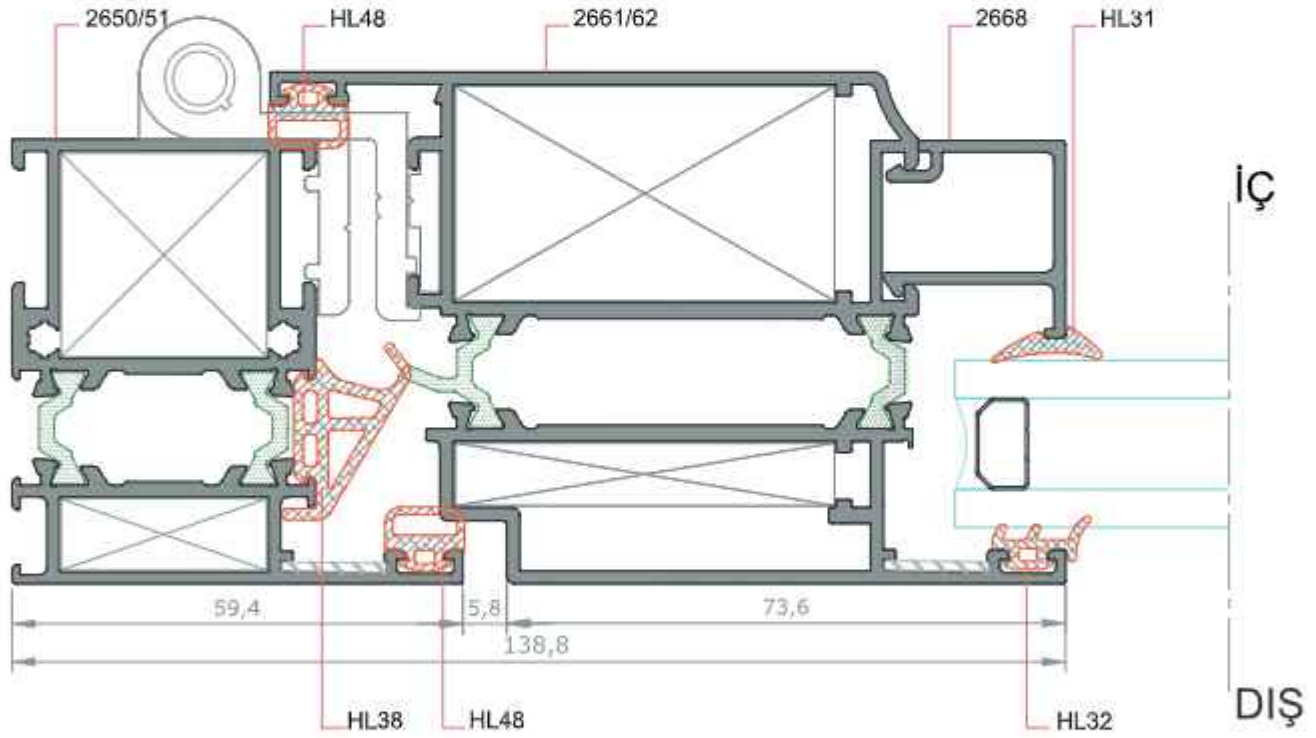

DETAY- 1b
ÖLÇEK: 1/1

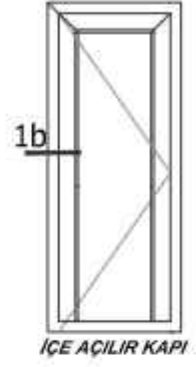

★ Yandaki profil birim ağırlıkları, bilgisayarda hesaplanmış teorik ağırlıklardır.

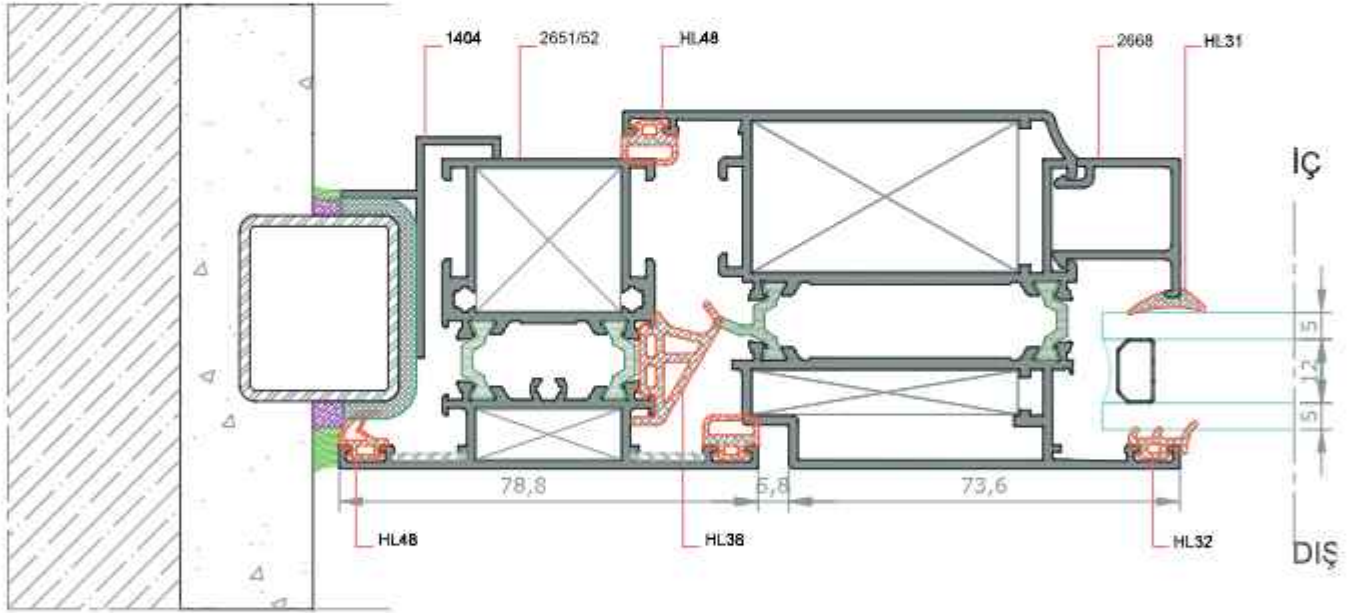

DETAY- 1c
ÖLÇEK:1/1

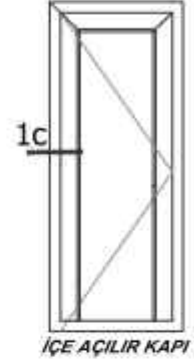

★ Yandaki profil birim ağırlıkları, bilgisayarda hesaplanmış teorik ağırlıklardır.

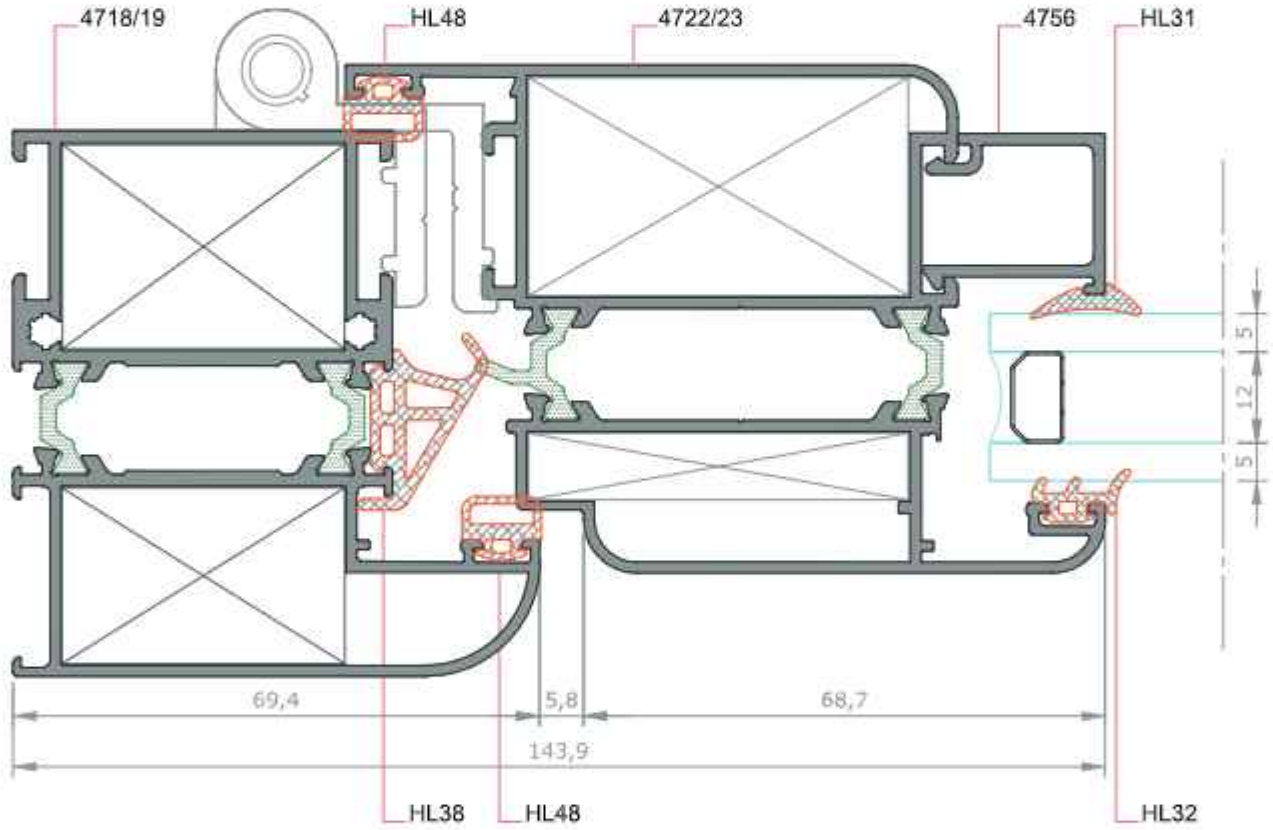

DETAY- 2a
ÖLÇEK:1/1

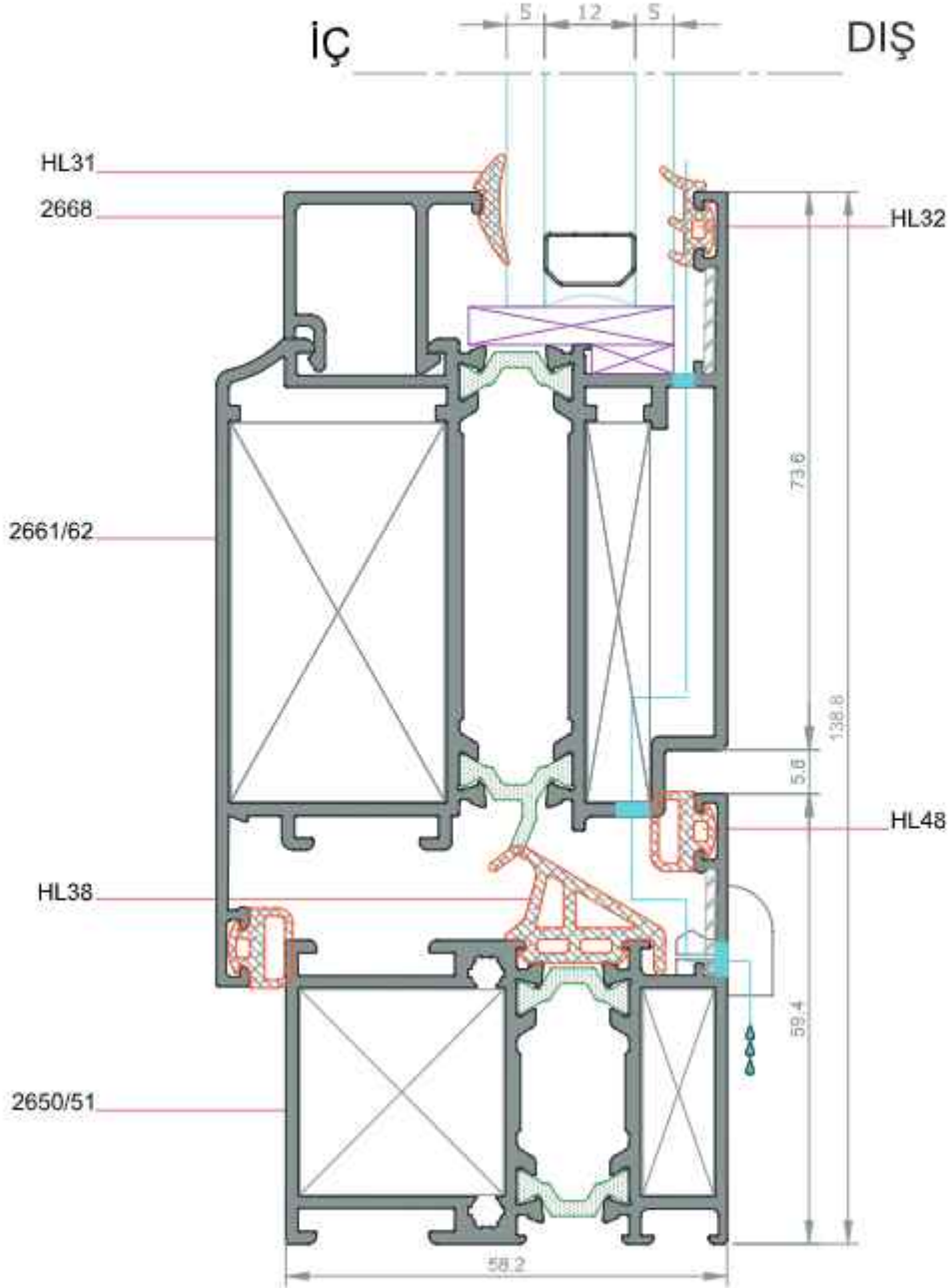
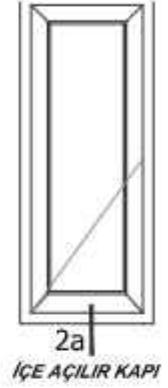

★ Yandaki profil birim ağırlıkları, bilgisayarla hesaplanmış teorik ağırlıklardır.

DETAY- 2b
ÖLÇEK:1/1

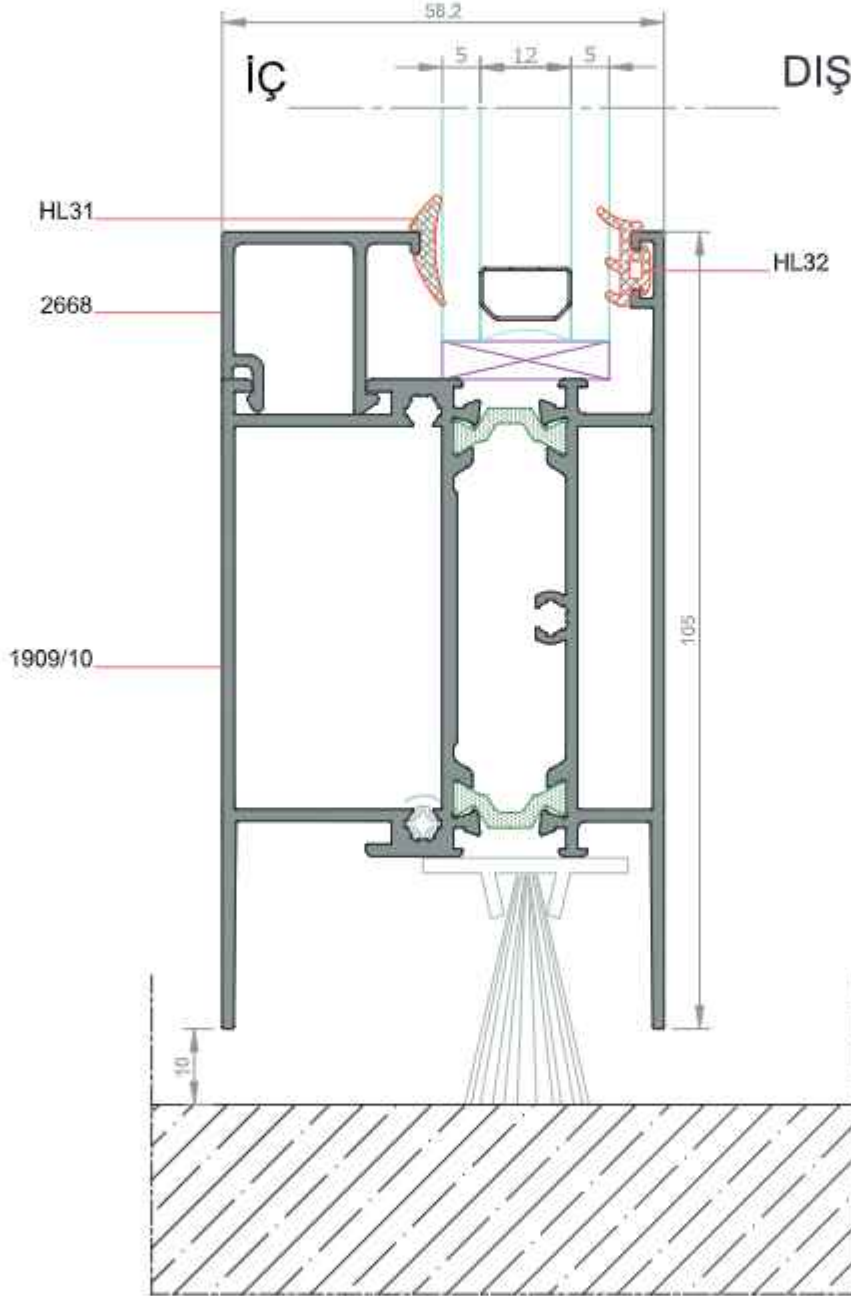

★ Yandaki profil birim ağırlıkları, bilgisayarla hesaplanmış teorik ağırlıklardır.

DETAY- 2c
ÖLÇEK:1/1

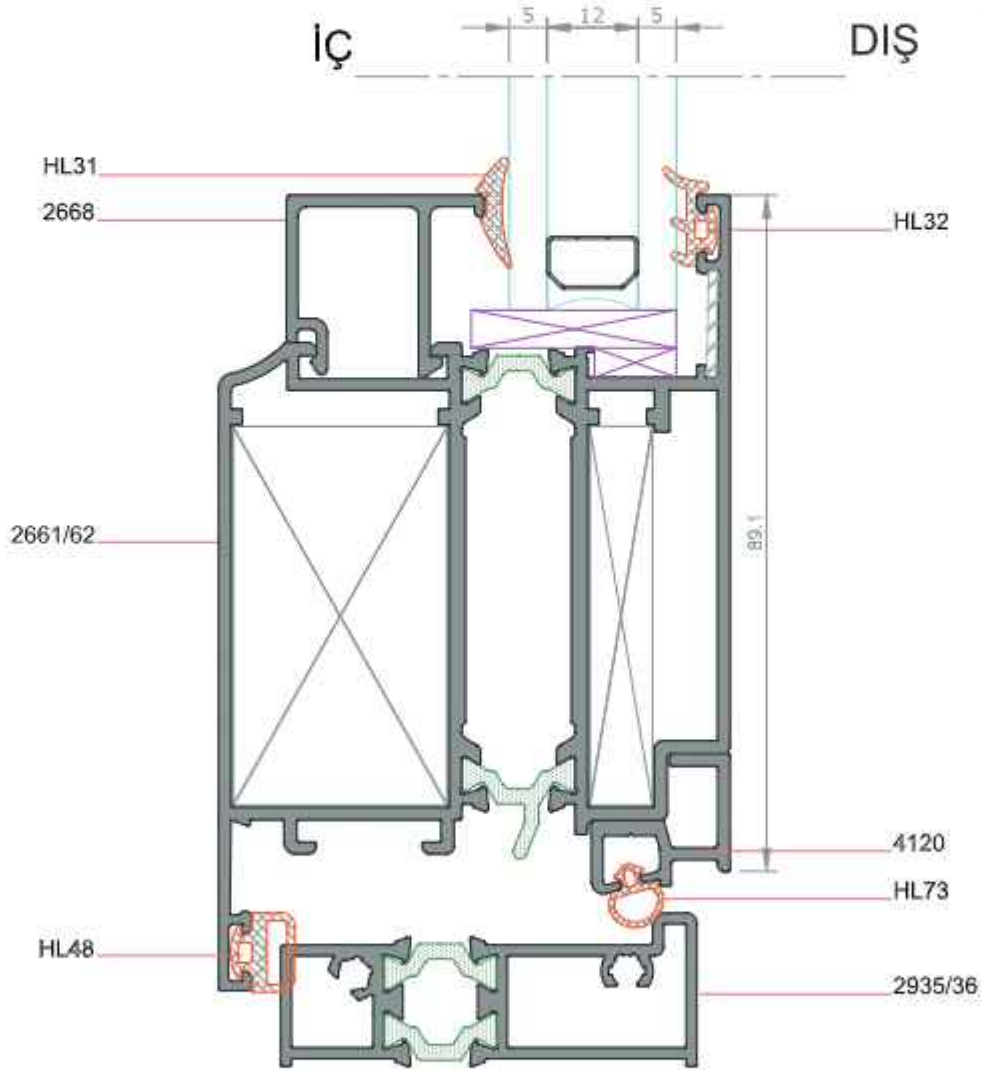
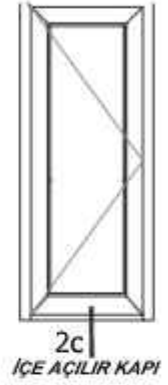

★ Yandaki profil birim ağırlıkları, bilgisayarla hesaplanmış teorik ağırlıklardır.

DETAY- 3

ÖLÇEK:1/1

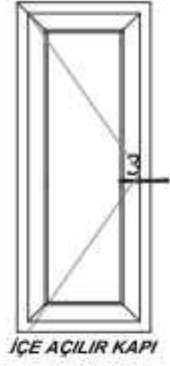

★ Yandaki profil birim ağırlıkları, bilgisayarda hesaplanmış teorik ağırlıklardır.

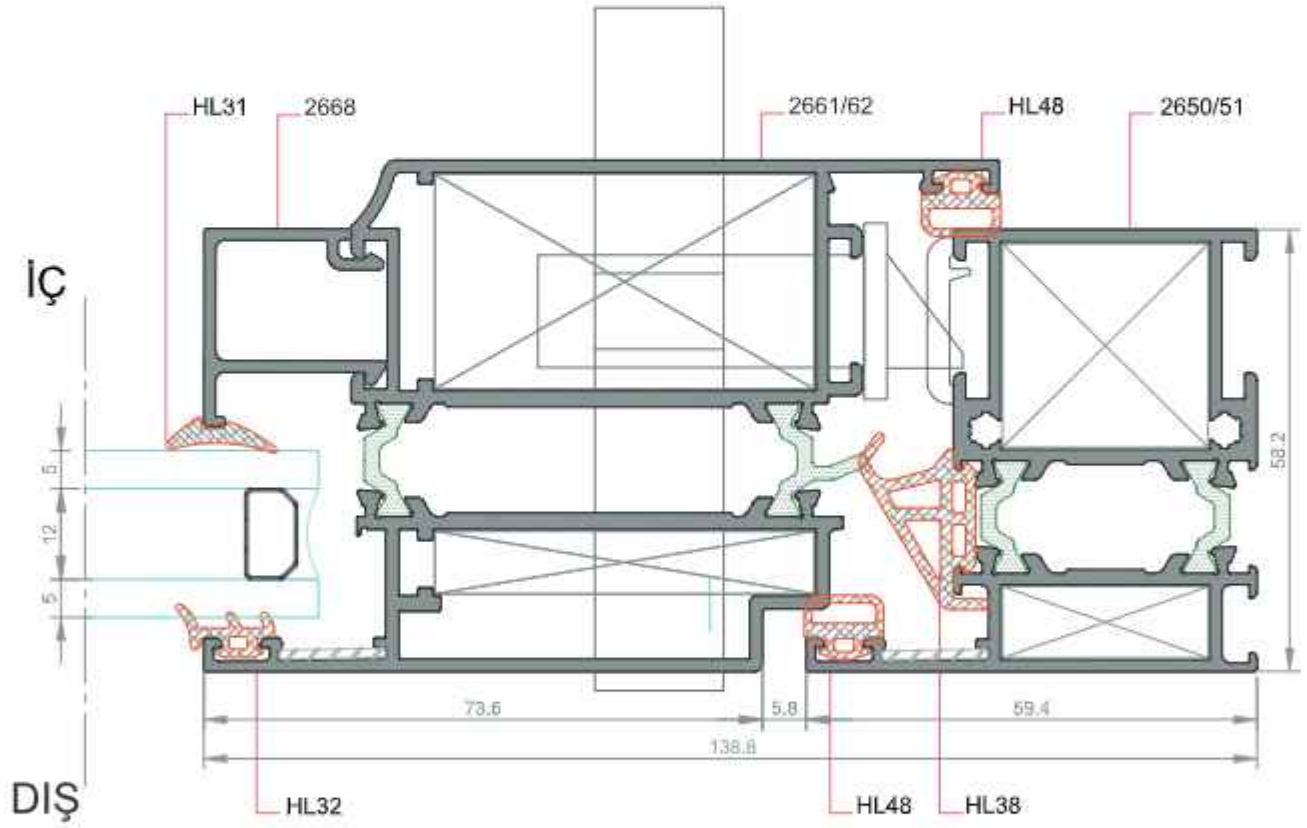

DETAY- 4
ÖLÇEK:1/1

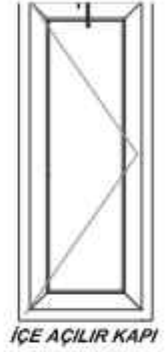

★ Yandaki profil birim ağırlıkları, bilgisayarla hesaplanmış teorik ağırlıklardır.

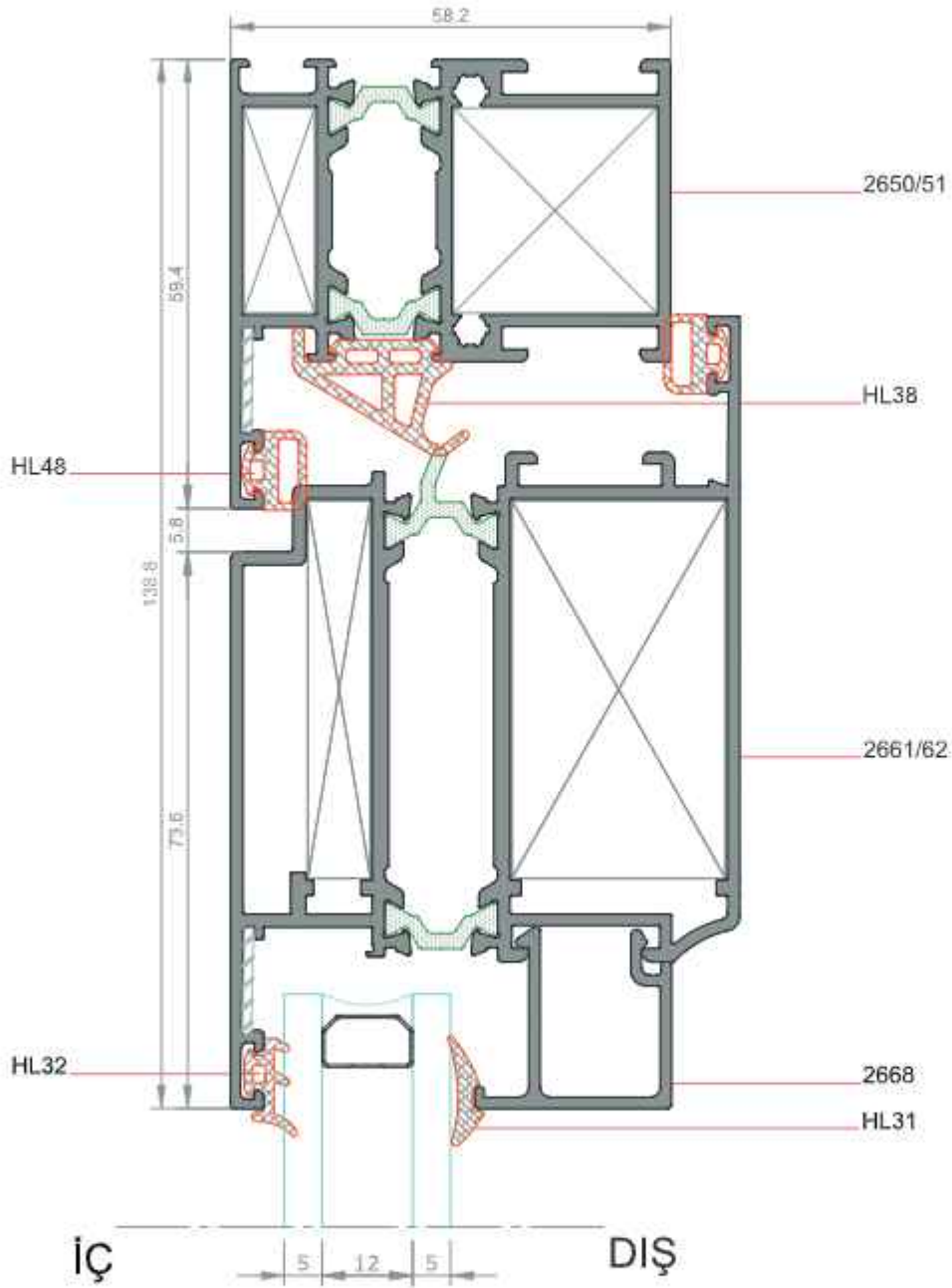

DETAY- 1a
ÖLÇEK:1/1

★ Yandaki profil birim ağırlıktan, bilgisayarla hesaplanmış hesaplanmış teorik ağırlıklardır.

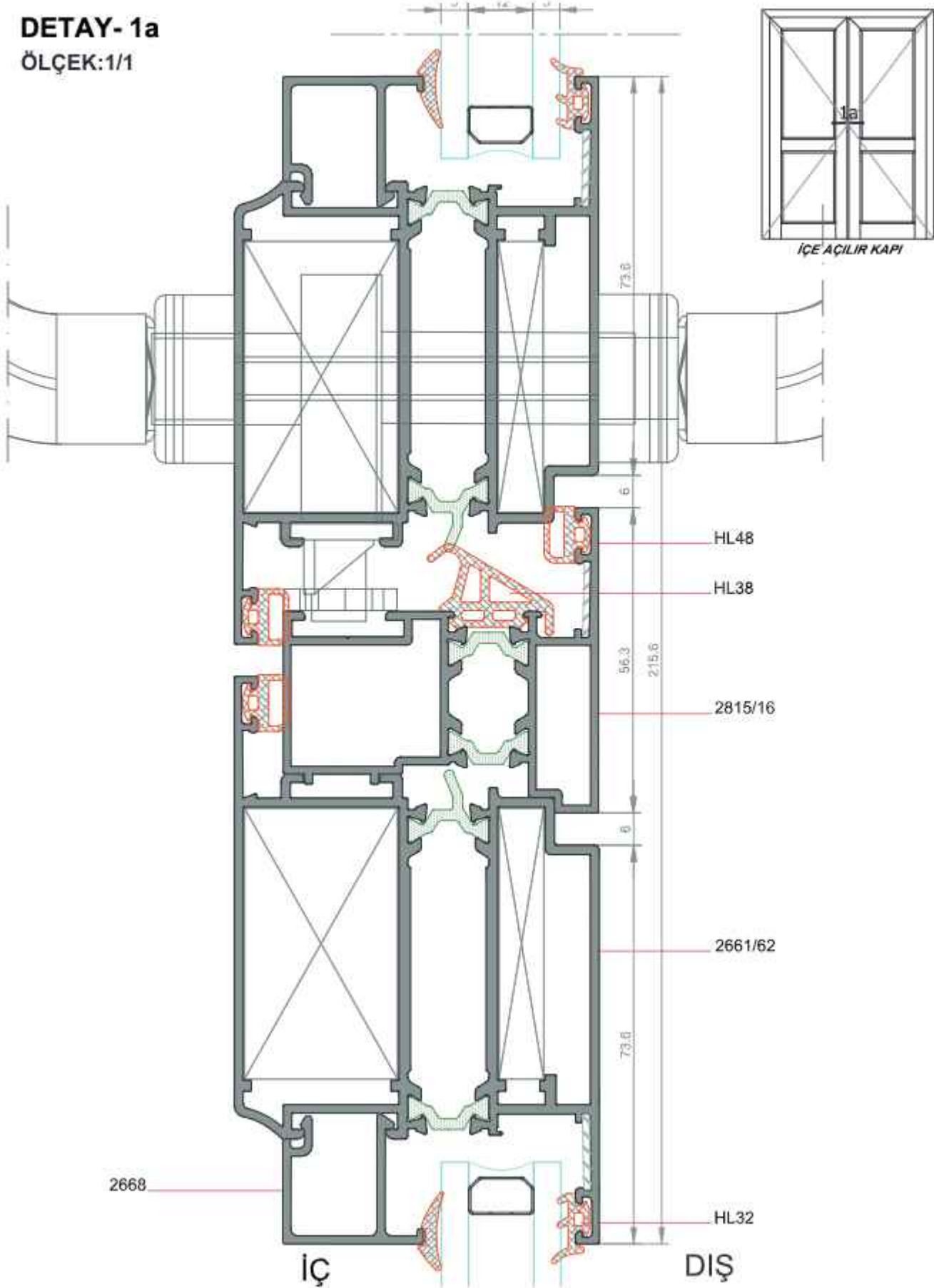

DETAY- 1b
ÖLÇEK:1/1

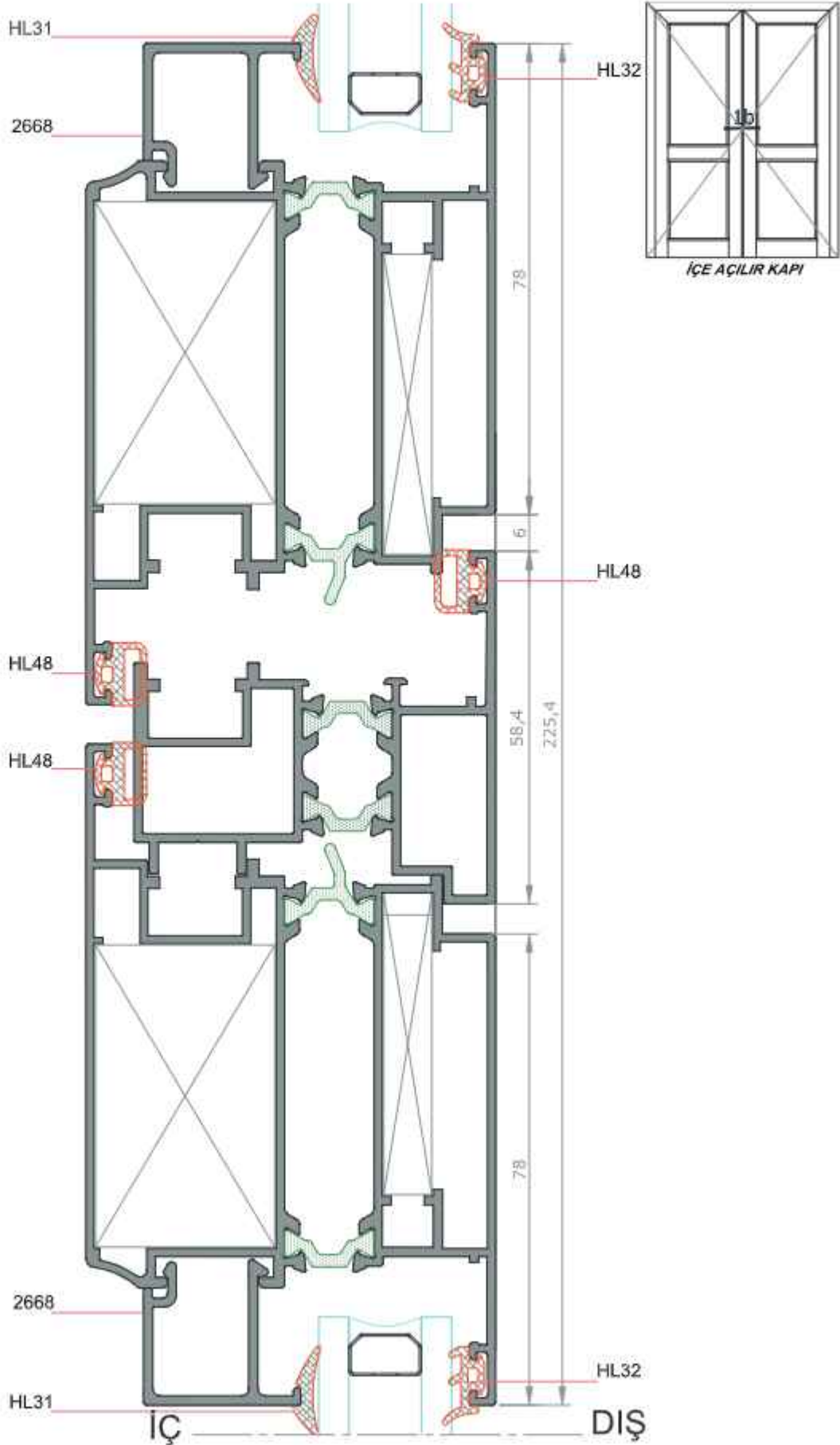

★ Yandaki profil birim ağırlıkları, bilgisayarla hesaplanmış teorik ağırlıklardır.

DETAY- 1
ÖLÇEK:1/1

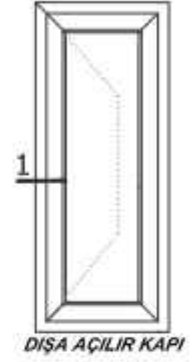

★ Yandaki profil birim ağırlıkları, bilgisayarda hesaplanmış teorik ağırlıklardır.

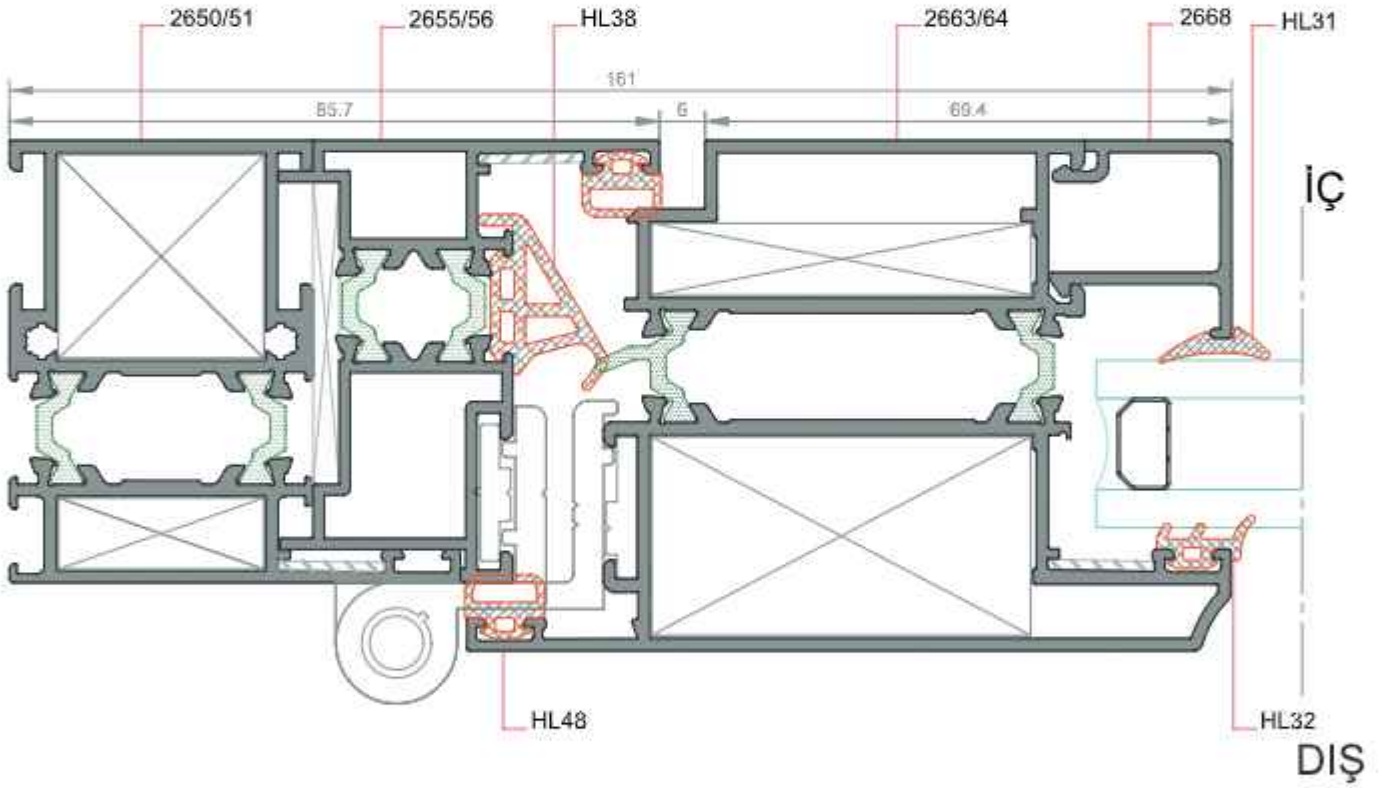

DETAY- 2a
ÖLÇEK:1/1

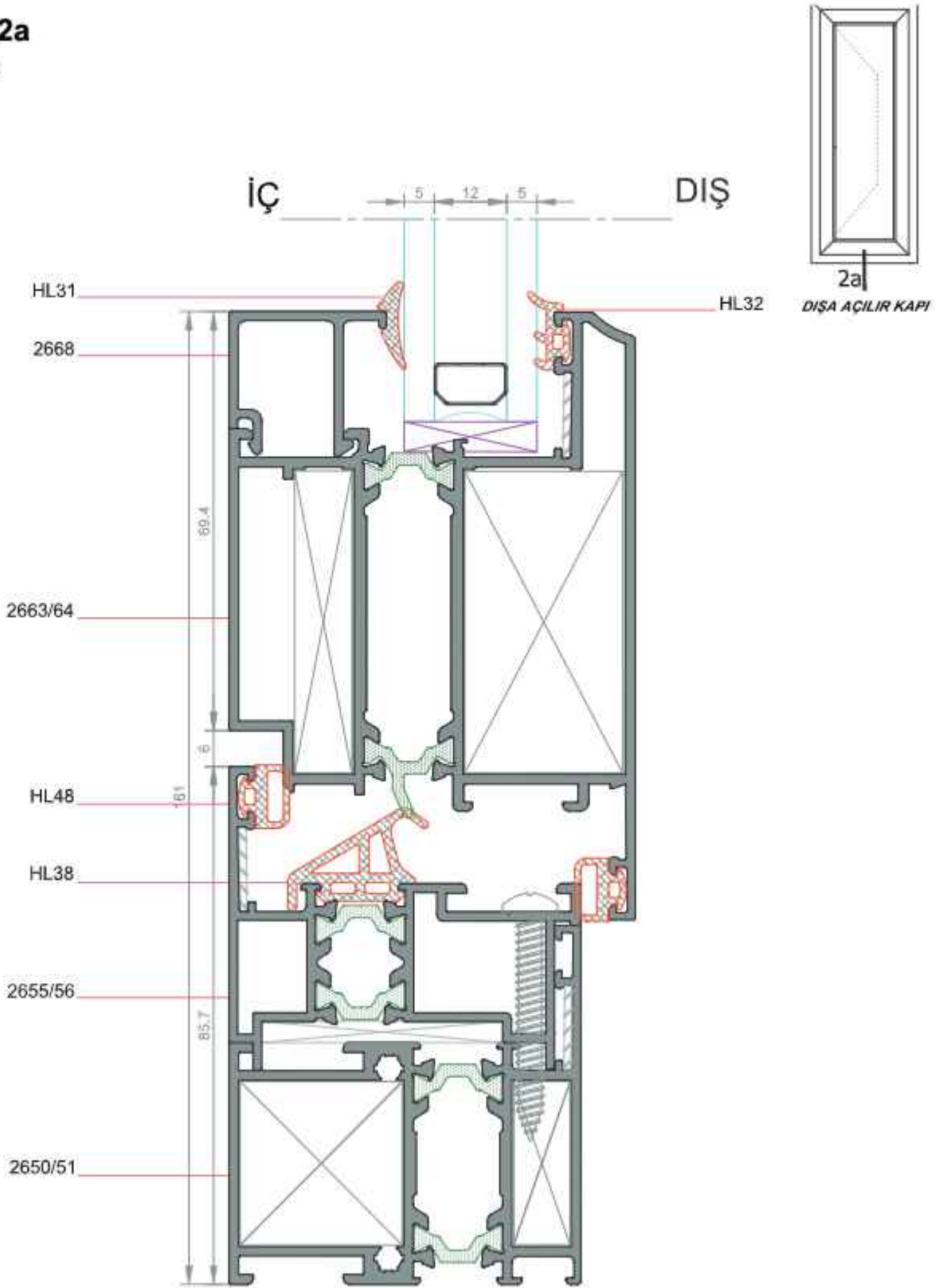

★ Yandaki profil birim ağırlıkları, bilgisayarla hesaplanmış teorik ağırlıklardır.

DETAY- 2b
ÖLÇEK:1/1

★ Yandaki profil birim ağırlıkları, bilgisayarla hesaplanmış teorik ağırlıklardır.

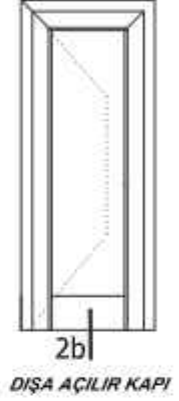
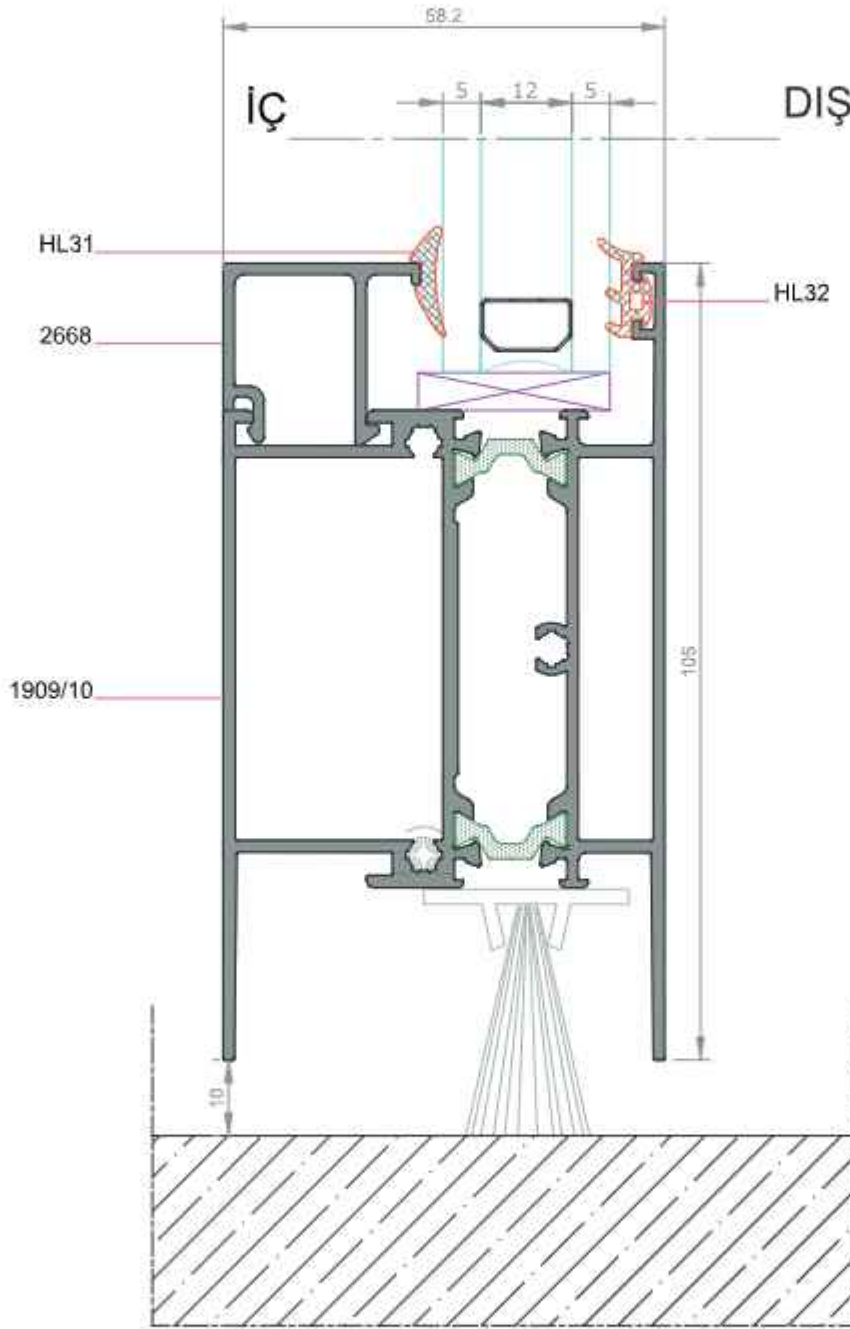

DETAY- 2c
ÖLÇEK:1/1

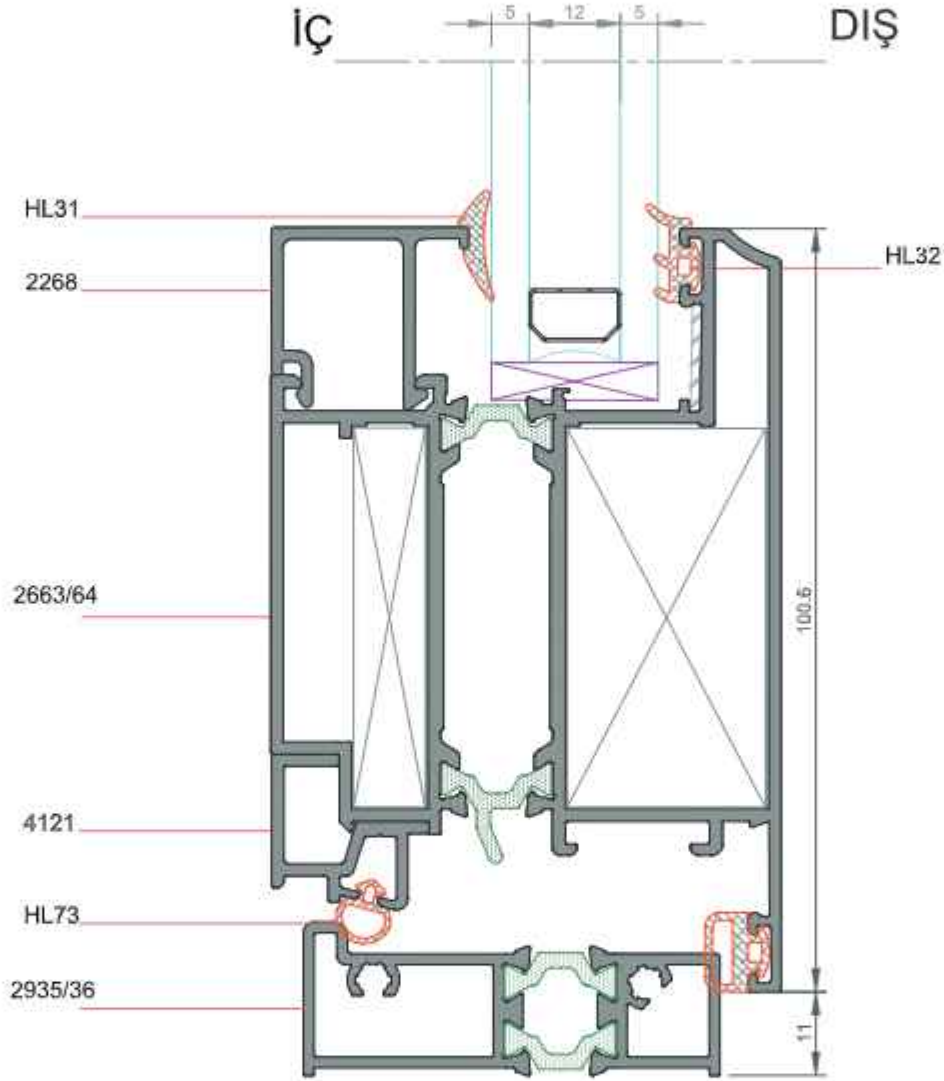
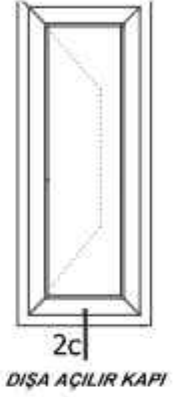

★ Yandaki profil birim ağırlıkları, bilgisayarla hesaplanmış teorik ağırlıklardır.

DETAY- 3

ÖLÇEK:1/1

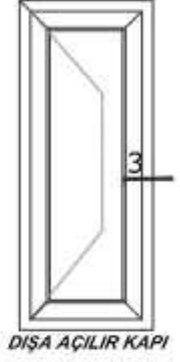

★ Yandaki profil birim ağırlıkları, bilgisayarda hesaplanmış teorik ağırlıklardır.

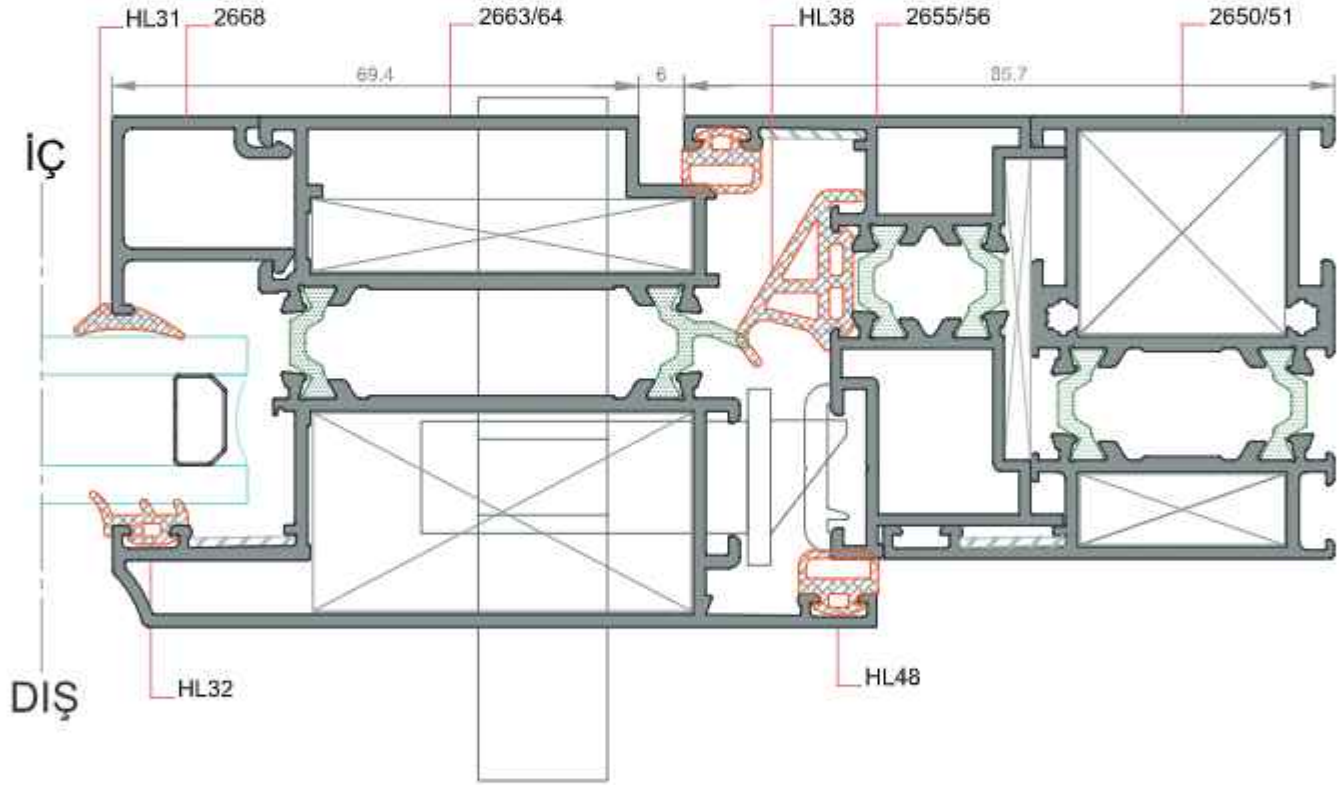

DETAY- 4
ÖLÇEK:1/1

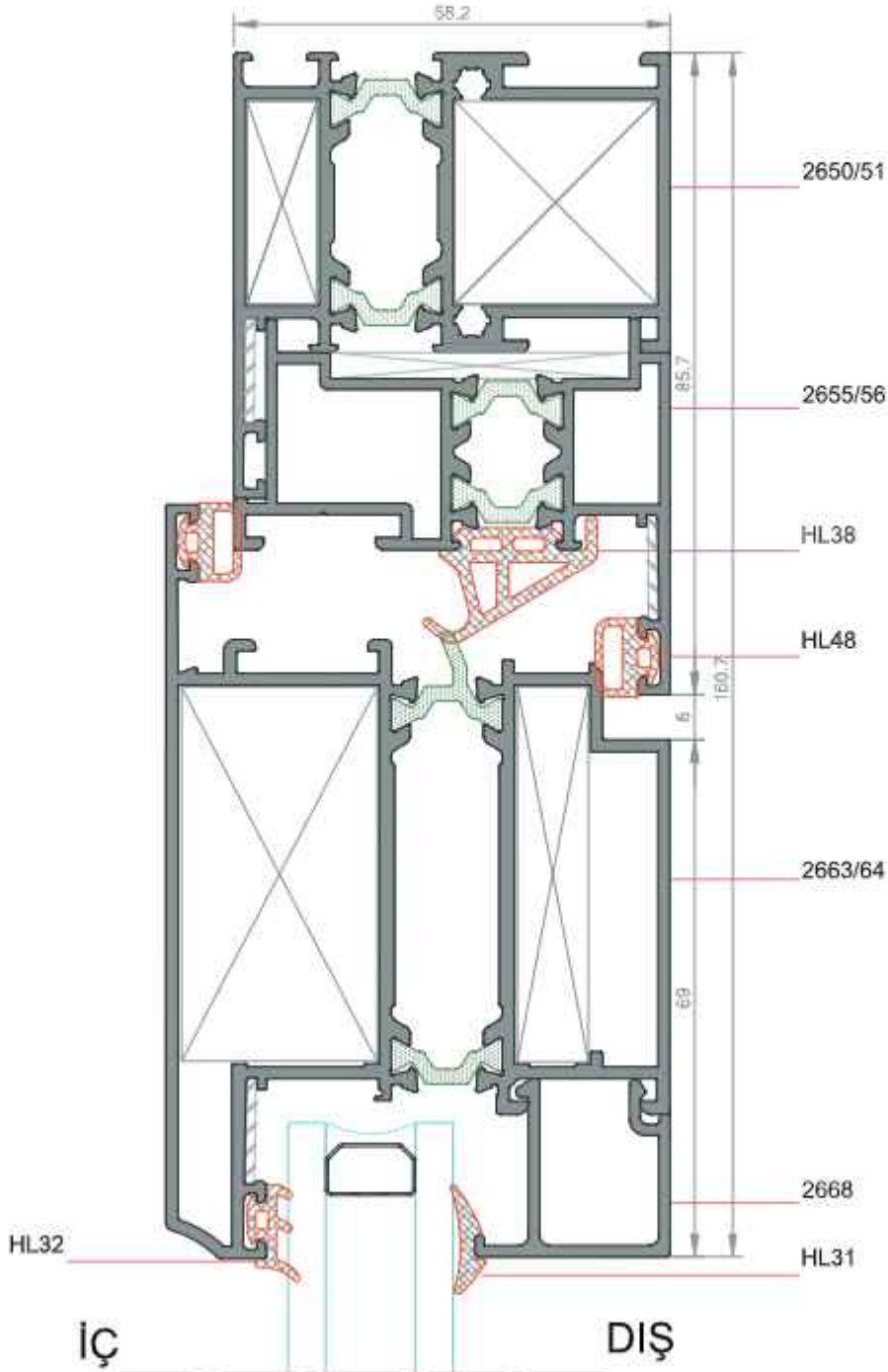
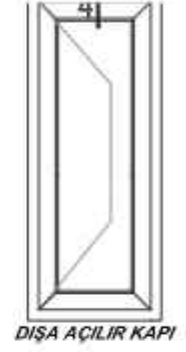

★ Yandaki profil birim ağırlıkları, bilgisayarla hesaplanmış teorik ağırlıklardır.

DETAY- 1

ÖLÇEK: 1/1

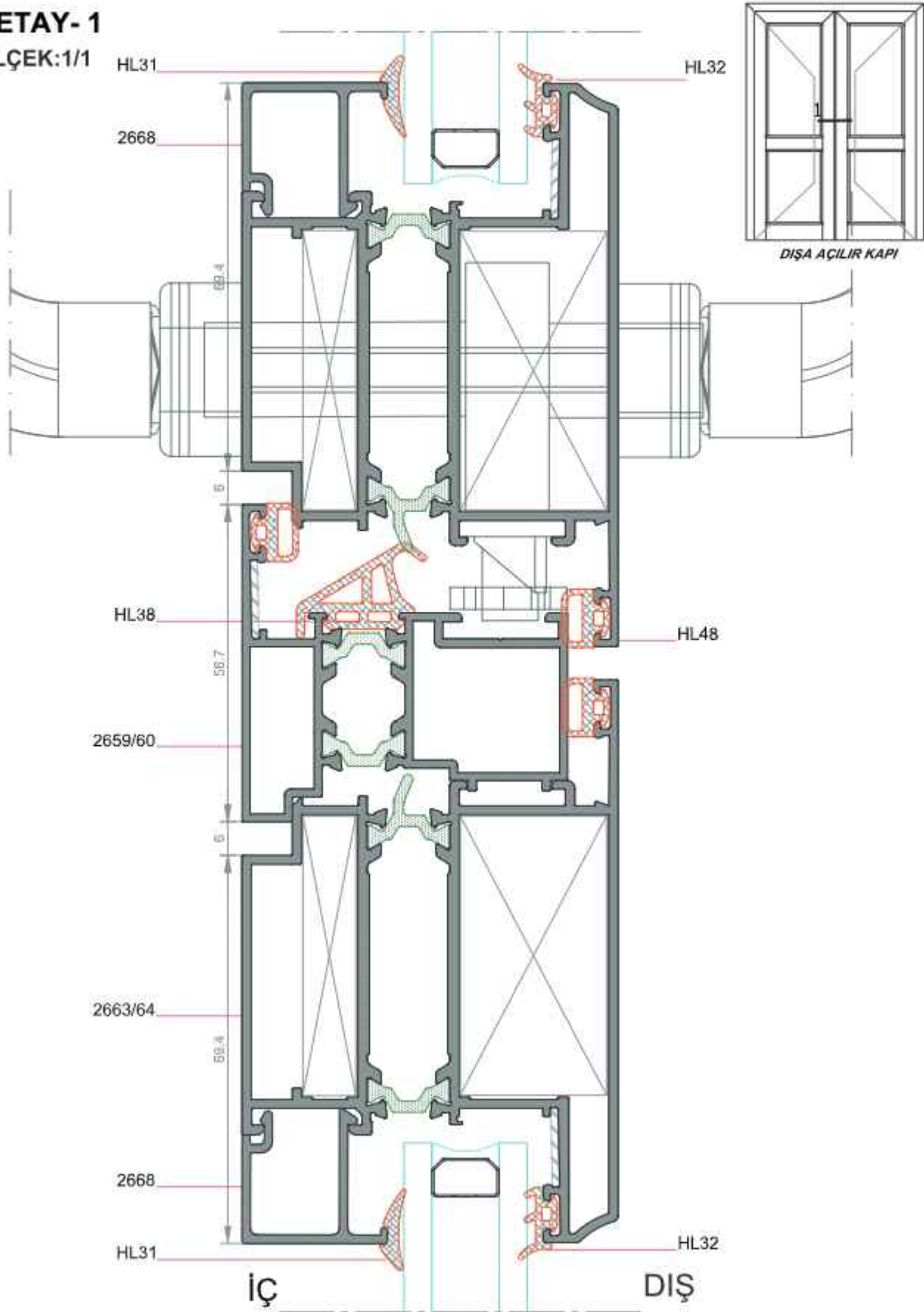

★ Yandaki profil birim ağırlıkları, bilgisayarla hesaplanmış teorik ağırlıklardır.

★ Yandaki profil birim ağırlıkları, bilgisayarda hesaplanmış teorik ağırlıklardır.

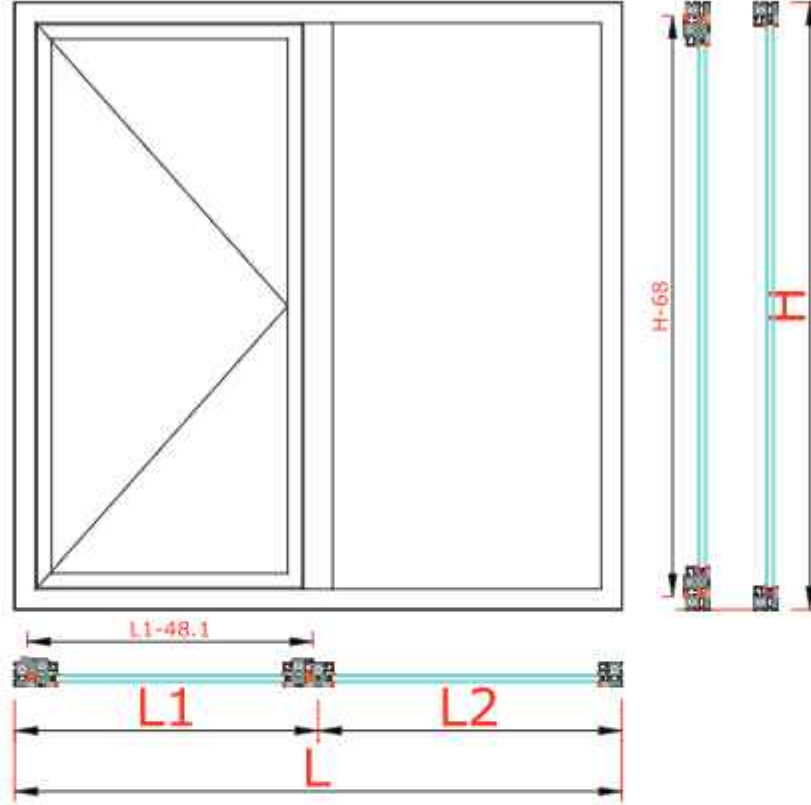

Profilin Adı	Profil Kodu	Profil Kesiti	Adet	Kesim Ölçüsü(mm)
Kasa Profili		2650/51 (1.6mm)	2	L
			2	H
Kanat Profili		2651/52 (1.6mm)	2	L1-48.1
			2	H-68
Orta Kayıt Profili		2653/54 (1.6mm)	1	H-70,6
Cam Çıtası Profili	Kanat		2	
			2	
Cam Çıtası Profili	Kasa Orta Kayıt		3	
			1	

Bağlantı Elemanları	Kod	Birim	Miktar
Köşe Takoğu (Kasa)	K3545 268	Adet	4
Köşe Takoğu (Kasa)	K3545 094	Adet	4
Köşe Takoğu (Kanat)	K3545 283	Adet	4
Köşe Takoğu (Kanat)	K3545 083	Adet	4
Köşe Gönye (Kasa)	MP56-04/3	Adet	4
Köşe Gönye (Kanat)	MP56-04/3	Adet	4

Cam (Açılır)	Adet	Cam Detayı	Kesim Ölçüsü (mm)
Dış Cam	1		
İç Cam			

Cam (Sabit)	Adet	Cam Detayı	Kesim Ölçüsü (mm)
Dış Cam	1		
İç Cam			

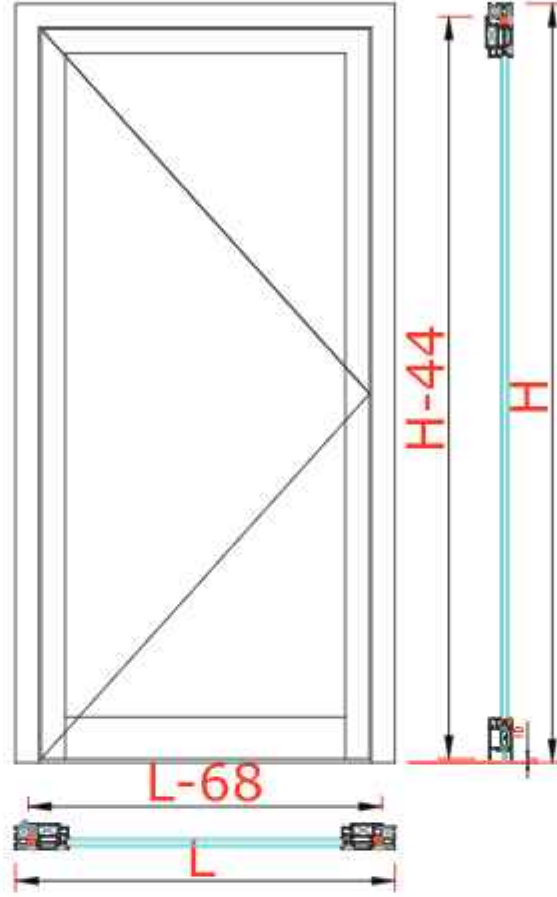

★ Yandaki profil birim ağırlıkları, bilgisayarla hesaplanmış teorik ağırlıklardır.

Profilin Adı	Profil Kodu	Profil Kesiti	Adet	Kesim Ölçüsü(mm)
Kasa Profili			1	L
			2	H
Kanat Profili			1	L-68
			2	H-44
Etek Profili			1	L-238,8
Cam Çıtası Profili <small>Not: Cam Çıtası profilleri dışarıya çıkarsa, her iki kasa tarafında bulunmalıdır.</small>	Kanat		2	
			2	
Cam Çıtası Profili <small>Not: Cam Çıtası profilleri sadece iç kasa tarafında bulunmalıdır.</small>	Etek		1	

Bağlantı Elemanları	Kod	Birim	Miktar
Köşe Takozu (Kasa)	K3545 268	Adet	2
Köşe Takozu (Kasa)	K3545 094	Adet	2
Köşe Takozu (Kanat)	K3546 283	Adet	2
Köşe Takozu (Kanat)	K3546 083	Adet	2
Köşe Gönye (Kasa)	MP56-04/3-1	Adet	2
Köşe Gönye (Kanat)	MP56-04/3-1	Adet	2

Cam (Açılır)	Adet	Cam Detayı	Kesim Ölçüsü (mm)
Dış Cam	1		
İç Cam			



PROFİL KATALOĐU















GXY H63 ISI YALITIMLI KAPI VE PENCERE SERİLERİ

*GXY H63 THERMAL INSULATED DOOR &
WINDOW SYSTEMS*













* Profil Ađırlıkları Teorik Olup Teslim Anındaki Ađırlık Geerlidir

* *Weight of profiles are theoretical, net weight will valid at the time of delivery.*







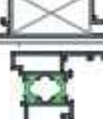



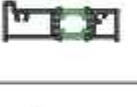
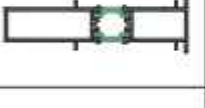

★ Yandaki profil birim ağırlıkları, bilgisayarda hesaplanmış teorik ağırlıklardır.

PROFİL KESİTİ	PROFİL KODU	PROFİL ADI	AĞIRLIK	ATALET MOMENTLERİ		SAYFA NO
				J_x (cm ⁴)	J_y (cm ⁴)	
	2909/10 (1.6mm)	Dar Kasa Profili	1,366 kg/m	21,69	6,98	
	2909/13 (1.6mm)	Dar Orta Kayıt Profili	1,471 kg/m	23,71	10,20	
	2911/12 (1.6mm)	Dar Kanat Profili	1,483 kg/m	34,60	7,05	
	2650/51 (1.4 mm)	Geniş Kasa Profili	1,434 kg/m	23,53	12,67	
	2650/51 (1.6 mm)	Geniş Kasa Profili	1,479 kg/m	25,72	13,60	
	2650/51 (1.8 mm)	Geniş Kasa Profili	1,644 kg/m	27,45	14,25	
	4452/53 (1.6 mm)	Geniş Kasa Profili	1,750 kg/m	30,47	22,62	
	4452/53 (1.8 mm)	Geniş Kasa Profili	1,827 kg/m	32,53	23,67	
	4718/19 (1.4 mm)	Geniş Oval Kasa Profili	1,893 kg/m	43,53	26,78	
	4894/4895 (1.5 mm)	Pervazlı Kasa Profili	1,617 kg/m	40,73	15,73	
	2651/52 (1.4 mm)	Geniş Orta Kayıt Profili	1,539 kg/m	25,07	18,31	
	2651/52 (1.6 mm)	Geniş Orta Kayıt Profili	1,675 kg/m	27,47	18,86	
	2651/52 (1.8 mm)	Geniş Orta Kayıt Profili	1,748 kg/m	29,22	35,63	
	2933/34 (1.6mm)	Baza Orta Kayıt Profili	2,086 kg/m	50,41	17,33	

★ Yandaki profil birim ağırlıkları, bilgisayarda hesaplanmış teorik ağırlıklardır.

PROFİL KESİTİ	PROFİL KODU	PROFİL ADI	AĞIRLIK	ATALET MOMENTLERİ		SAYFA NO
				J_x (cm ⁴)	J_y (cm ⁴)	
	2651/4513 (1.6 mm)	Takviyeli Orta Kayıt Profili	1,762 kg/m	50,41	35,25	
	4720/21 (1.4 mm)	Oval Kanat Profili	1,586 kg/m	39,38	13,64	
	2653/54 (1.4 mm)	Geniş Kanat Profili	1,577 kg/m	38,56	13,53	
	2653/54 (1.6 mm)	Geniş Kanat Profili	1,681 kg/m	40,63	10,47	
	2653/54 (1.8 mm)	Geniş Kanat Profili	1,785 kg/m	42,74	16,38	
	3478/79 (1.3mm)	PVC Kanallı Pencere Kanadı	1,552 kg/m	36,72	40,01	
	2932/2654 (1.5mm)	PVC Kanallı Pencere Kanadı	1,846 kg/m	56,91	42,73	
	2661/62 (1.6 mm)	Kapı Kanat Profili	2,217 kg/m	62,91	37,02	
	2661/62 (1.8 mm)	Kapı Kanat Profili	2,281 kg/m	65,55	38,35	
	3483/84 (1.3mm)	Kapı Kanat Profili	2,047 kg/m	71,59	14,91	
	4722/23 (1.5 mm)	Oval Kapı Kanat Profili	1,903 kg/m	60,21	30,90	
	2663/64 (1.6 mm)	Kapı Kanat Profili (Dışa Açılır)	2,234 kg/m	56,05	48,15	
	2663/64 (1.8 mm)	Kapı Kanat Profili (Dışa Açılır)	2,341 kg/m	58,35	51,56	
	2659/60 (1.4mm)	Dışa Açılır Çift Kapı Adaptörü	1,199 kg/m	16,78	6,42	





★ Yandaki profil birim ağırlıkları, bilgisayarda hesaplanmış teorik ağırlıklardır.

PROFİL KESİTİ	PROFİL KODU	PROFİL ADI	AĞIRLIK	ATALET MOMENTLERİ		SAYFA NO
				J_x (cm ⁴)	J_y (cm ⁴)	
	2655/56 (1.4mm)	Dışa Açılır Kapı Adaptörü	1,150 kg/m	17,68	5,25	
	2815/16 (1.5mm)	Çift Kapı Adaptörü	1,323 kg/m	22,68	8,15	
	3556/57 (1.4mm)	PCV Kanallı Çift Kanat Adaptörü	1,358 kg/m	23,96	8,51	
	4899/4900 (1.5mm)	Pivot Kanat Adaptörü	1,404 kg/m	25,75	9,34	
	1909/10 (1.6mm)	Etek Profili	2,171 kg/m	52,72	32,24	
	2935/36 (1.4mm)	Eşik Profili	0,860 kg/m	11,40	1,24	
	3141/42 (1.4mm)	Ek Profili	1,265 kg/m	43,28	3,25	
	4120	Eşik-Kanat Adaptör Profili-İç	0,245 kg/m	
	4121	Eşik-Kanat Adaptör Profili-Dış	0,279 kg/m	
	2260	Pervaz Profili	0,625 kg/m	
	2259	Pervaz Profili	0,486 kg/m	
	1210	İspanyolet Çubuğu	0,112 kg/m	
	2660	Köşe Dönüş Adaptörü Dış	0,181 kg/m	
	2667	Köşe Dönüş Adaptörü İç	0,179 kg/m	

★ Yandaki profil birim ağırlıkları, bilgisayarda hesaplanmış teorik ağırlıklardır.

PROFİL KESİTİ	PROFİL KODU	PROFİL ADI	AĞIRLIK	ATALET MOMENTLERİ		SAYFA NO
				J_x (cm ⁴)	J_y (cm ⁴)	
	4124	Cam Çitası	0,308 kg/m	
	2668	Cam Çitası	0,330 kg/m	
	2657	Cam Çitası	0,332 kg/m	
	2914	Cam Çitası	0,349 kg/m	
	3136	Cam Çitası	0,364 kg/m	
	3183	Cam Çitası	0,377 kg/m	
	4122	Cam Çitası	0,390 kg/m	
	4123	Cam Çitası	0,402 kg/m	
	2181	Damlalık Profili	0,168 kg/m	
	1980	55'lik Boru Profili	0,902 kg/m	
	2150	60'lık Boru Profili	0,891 kg/m	
	4733/34	Köşe Profili	0,863 kg/m	39,43	25,11	
	4125	Çektirme Takozu	1,099 kg/m	
	4133	Çektirme Takozu	0,566 kg/m	

★ Yandaki profil birim ağırlıkları, bilgisayarda hesaplanmış teorik ağırlıklardır.

PROFİL KESİTİ	PROFİL KODU	PROFİL ADI	AĞIRLIK	ATALET MOMENTLERİ		SAYFA NO
				J_x (cm ⁴)	J_y (cm ⁴)	
	3545	Köşe Takozu	4,616 kg/m	
	2929	Köşe Takozu	3,341 kg/m	
	2917	Köşe Takozu	3,469 kg/m	
	3546	Köşe Takozu	6,304 kg/m	







★ Yandaki profil birim ağırlıkları, bilgisayarda hesaplanmış teorik ağırlıklardır.

AKSESUAR KESİTİ	AKSESUAR KODU	AKSESUAR ADI	AĞIRLIK	PAKETLEME	SAYFA NO
	HL16	Orta Bini Fiteli	200 gr/m	15kg/ 75m	
	HL48	Kanat Fiteli	73 gr/m	15 kg/ 205m	
	HL32	Dış Cam Fiteli	46 gr/m	15kg/326m	
	HL31(2mm)	Kama Fiteli	40 gr/m	15kg/ 375m	
	HL07(4mm)	Kama Fiteli	63 gr/m	15kg/ 238m	
	HL04(3mm)	Kama Fiteli	60 gr/m	15kg/ 250m	
	HL73	Eşik Fiteli	30 gr/m	15 kg/ 500m	
	MP31-02/09-1	Paslanmaz Tek Büküm Oval Yale Kol	...	30 Ad/ 1 Paket	
	MP-HG 63	Çift Kapı Adaptör Kapağı 1Takım (Sağ-Sol)	...	25Sağ 25Sol/ 1 Paket	
	MP-6-36138 -20-LR-0-1	Menteşe	...	100 Ad/ 1 Paket	
	MP26-03/2	Menteşe	...	150 Ad/ 1 Paket	
	MP56-07/5H	Seri Sistem Mentşe	...	200 Ad/ 1 Paket	
	00535	Kapı Mentşe	...	200 Ad/ 1 Paket	

★ Yandaki profil birim ağırlıkları, bilgisayarda hesaplanmış teorik ağırlıklardır.

AKSESUAR KESİTİ	AKSESUAR KODU	AKSESUAR ADI	AĞIRLIK	PAKETLEME	SAYFA NO
	MP-56-04/3-1	Köşe Gönye	...	250 Ad/ Paket	
	MP31-11	Boru Kol	...	10 Ad/ 1 Paket	
	MP29-04	Alüminyum Pencere Kolu	...	100 Ad/ 1 Paket	
	MP32-01/1	Boyunlu Eksenel Kol Tek Dilli	...	50 Ad/ 1 Paket	
	MP31-01	Yaylı Sosis Kol	...	50 Ad/ 1 Paket	
	MP31-09/13	Yaylı Dar Aynalı Sosis Kol	...	30 Ad/ 1 Paket	
	MP31-07/2Y	Yaylı Düz Rozetli Sosis Kol	...	50 Ad/ 1 Paket	
	MP31-24/2H	Akbank Havuzlu Kol Aparatı	...	30 Ad/ 1 Paket	
	MP31-24/20	Akbank 40'lık Kol Aparatı	...	30 Ad/ 1 Paket	
	MP34-254/96	96 mm Barel	...	30 Ad/ 1 Paket	
	MP34-04/5	Dilli Kilit (153-35)	...	30 Ad/ 1 Paket	
	MP34-02/7	Makaralı Kilit (155-35)	...	30 Ad/ 1 Paket	

★ Yandaki profil birim ağırlıkları, bilgisayarda hesaplanmış teorik ağırlıklardır.

AKSESUAR KESİTİ	AKSESUAR KODU	AKSESUAR ADI	AĞIRLIK	PAKETLEME	SAYFA NO
	MP33-12	Isı yalıtımlı Uzun Sürgü	...	100 Ad/ 1 Paket	
	MP56-01/6/3-1	Dilli Kilit Karşılığı	...	50 Ad/ 1 Paket	
	MP56-01/6/6	Makaralı Kilit Karşılığı	...	50 Ad/ 1 Paket	
	MP28-02	(40,60,80,100,120) (140,160,180,200cm) 7,5 mm göbekli ispanyolet	...	50 Ad/ 1 Paket 30 Ad/ 1 Paket	
	MP32-34/3	İspanyolet Pim Takımı	...	100 Ad/ 1 Paket	
	MP33-09/4-3	Vasistas Makası	...	100 Ad/ 1 Paket	
	MP33-15/5	Cico Avrupa Vasistas Çıtçıt	...	50 Ad/ 1 Paket	
	MP32-33/1	Ayarlı Karşılık	...	500 Ad/ 1 Paket	
	TS 71	Kapı Hidroliği	...	10 Ad/ 1 Paket	
	MP33-04/2	Kapı Altı Fırçası	...	100 Ad/ 1 Paket	
	MP33-04/3	Y Kapı Alt Fırçası	...	100 Ad/ 1 Paket	
	MP26-05	Su Tahliye Tapası	...	2000 Ad/ 1 Paket	
	HE-9991	Pvc Tij	...	200 m / 1 Paket	

★ Yandaki profil birim ağırlıkları, bilgisayarda hesaplanmış teorik ağırlıklardır.

AKSESUAR KESİTİ	AKSESUAR KODU	AKSESUAR ADI	AĞIRLIK	PAKETLEME	SAYFA NO
	MP-9998	Kesme ve Delme Makinası	...	1 Ad/ Paket	

★ Yandaki profil birim ağırlıkları, bilgisayarla hesaplanmış teorik ağırlıklardır.

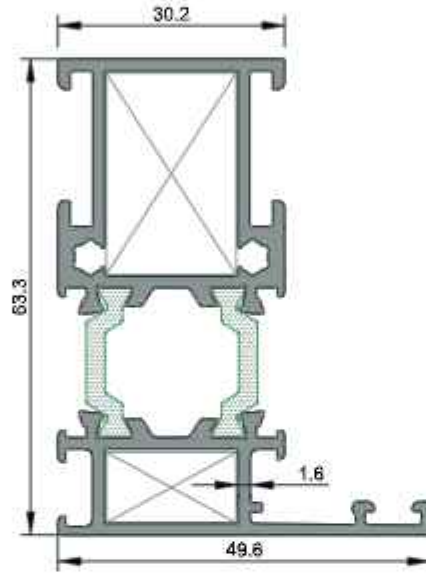

2909/10
Dar Kasa Profili
1,366 kg/m
$J_x=21,69 \text{ cm}^4$ $J_y=6,98 \text{ cm}^4$

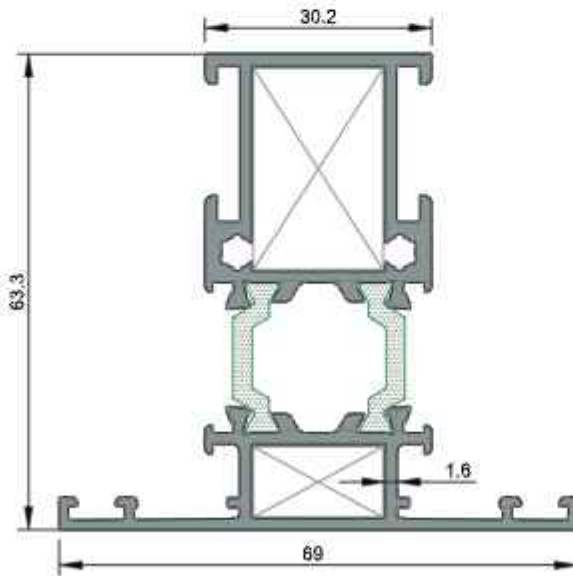

2909/13
Dar Orta Kayıt Profili
1,471 kg/m
$J_x=23,71 \text{ cm}^4$ $J_y=10,20 \text{ cm}^4$

★ Yandaki profil birim ağırlıkları, bilgisayarla hesaplanmış teorik ağırlıklardır.

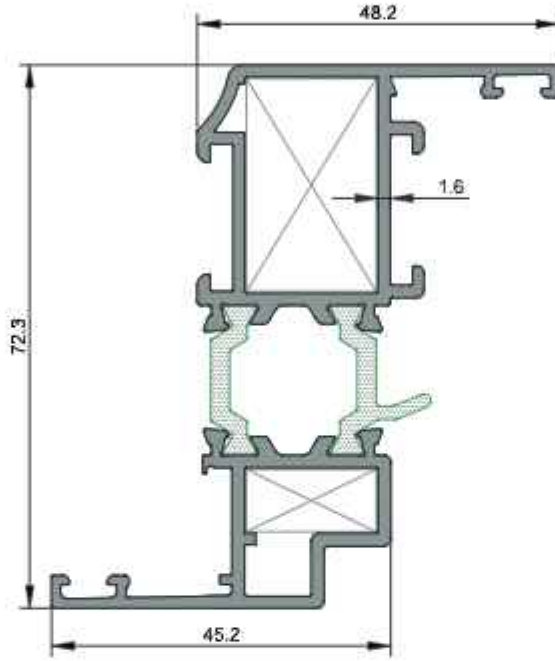

2911/12
Dar Kanat Profili
1,483 kg/m
Jx=34,20 cm ⁴ Jy=7,04 cm ⁴

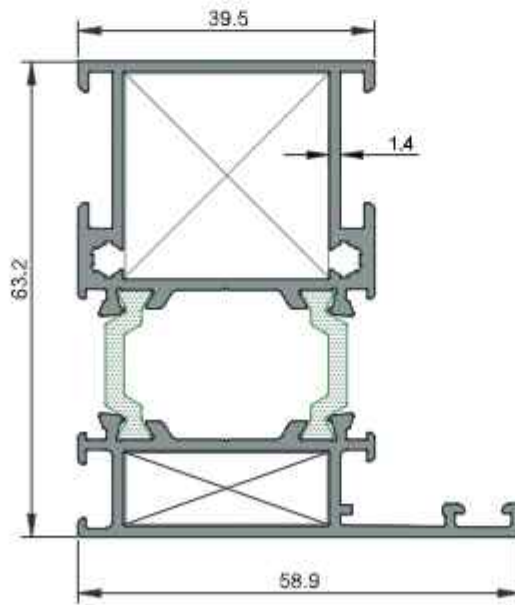

2650/51(1.4mm)
Geniş Kasa Profili
1,434 kg/m
Jx=23,53 cm ⁴ Jy=12,67 cm ⁴

★ Yandaki profil birim ağırlıkları, bilgisayarda hesaplanmış teorik ağırlıklardır.

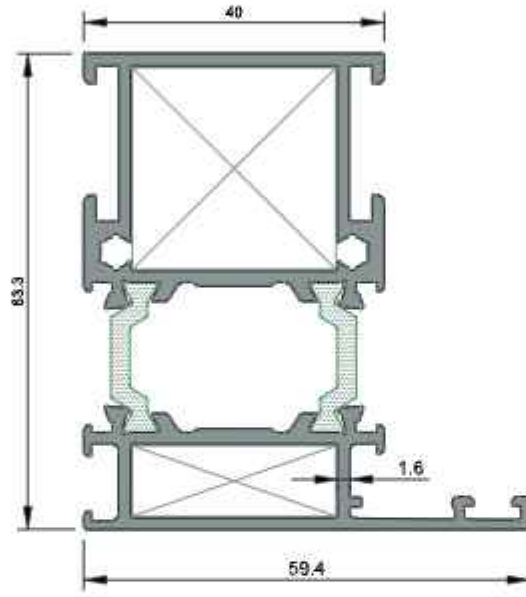

2650/51 (1.6mm)
Geniş Kasa Profili
1,479 kg/m
Jx=25,56 cm ⁴ Jy=13,60 cm ⁴

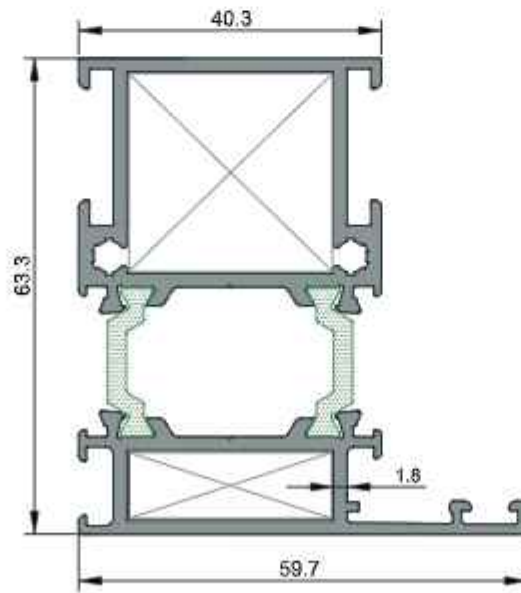

2650/51 (1.8mm)
Geniş Kasa Profili
1,644 kg/m
Jx=27,45 cm ⁴ Jy=14,25 cm ⁴

★ Yandaki profil birim ağırlıkları, bilgisayarla hesaplanmış teorik ağırlıklardır.

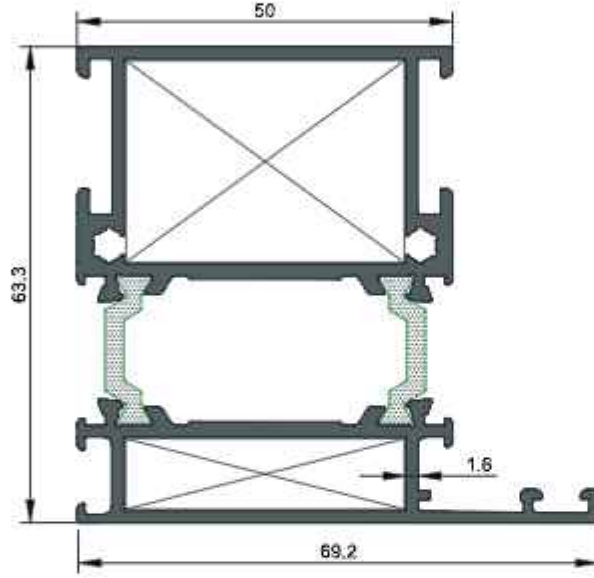

4452/53(1.6mm)
Geniş Kasa Profili
1,750 kg/m
Jx=30,47 cm ⁴ Jy=22,62 cm ⁴

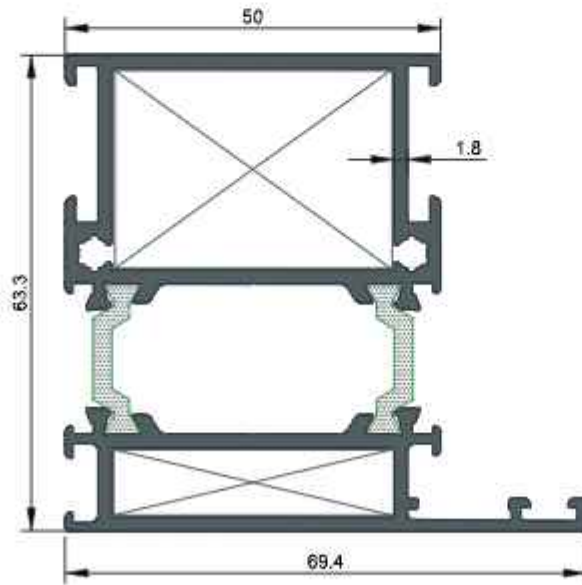

4452/53(1.8mm)
Geniş Kasa Profili
1,827 kg/m
Jx=32,53 cm ⁴ Jy=23,67 cm ⁴

★ Yandaki profil birim ağırlıkları, bilgisayarda hesaplanmış teorik ağırlıklardır.

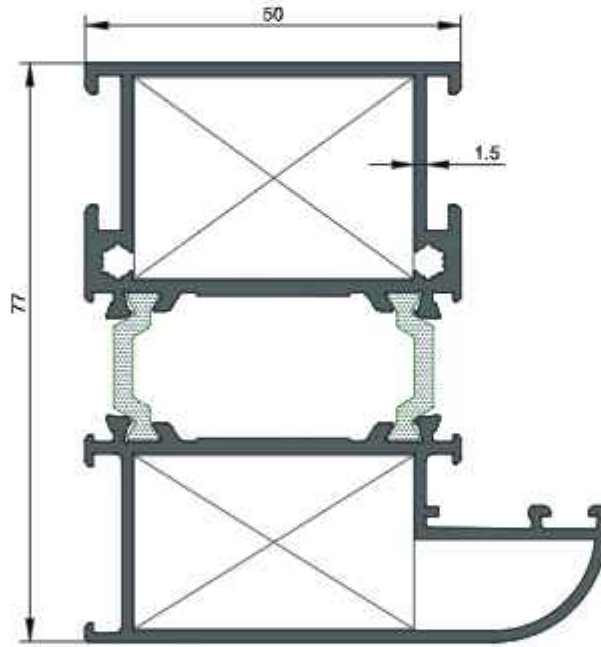

4718/4719
Oval Kasa Profili
1,893 kg/m
$J_x= 43,53 \text{ cm}^4$ $J_y=26,78 \text{ cm}^4$

★ Yandaki profil birim ağırlıkları, bilgisayarla hesaplanmış teorik ağırlıklardır.

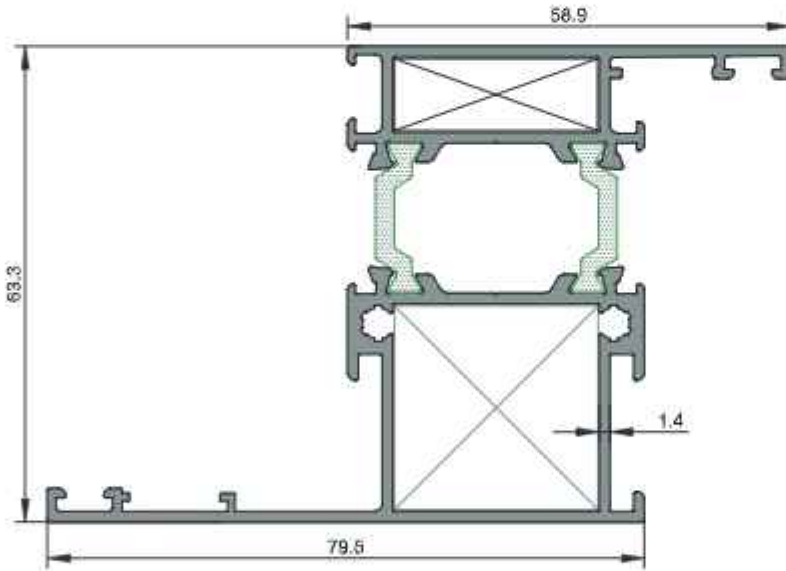

4894/4895
Pervazlı Kasa Profili
1,617 kg/m
$J_x=40,73 \text{ cm}^4$ $J_y=15,73 \text{ cm}^4$

★ Yandaki profil birim ağırlıkları, bilgisayarda hesaplanmış teorik ağırlıklardır.

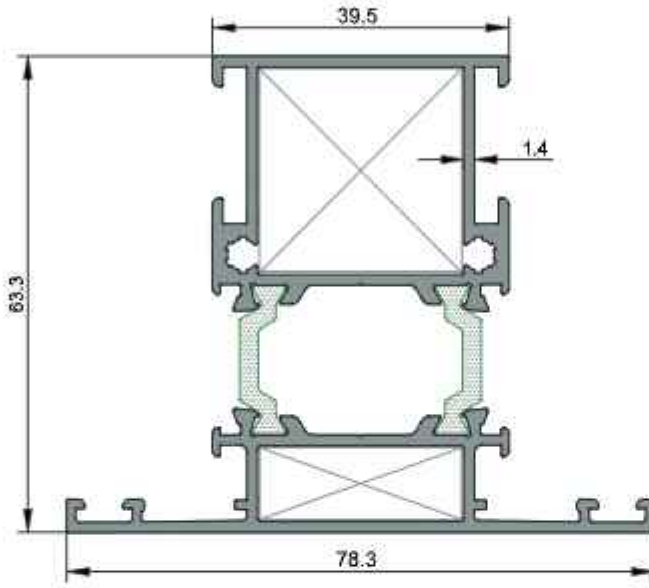

2651/52(1.4mm)
Geniş Orta Kayıt Profili
1,539 kg/m
Jx=25,07 cm ⁴ Jy= 17,33 cm ⁴

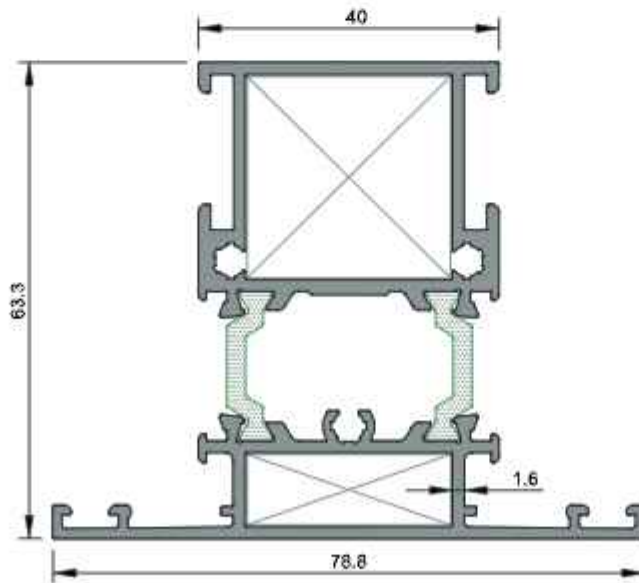

2651/52(1.6mm)
Geniş Orta Kayıt Profili
1,675 kg/m
Jx=27,26 cm ⁴ Jy=18,31 cm ⁴

★ Yandaki profil birim ağırlıkları, bilgisayarla hesaplanmış teorik ağırlıklardır.

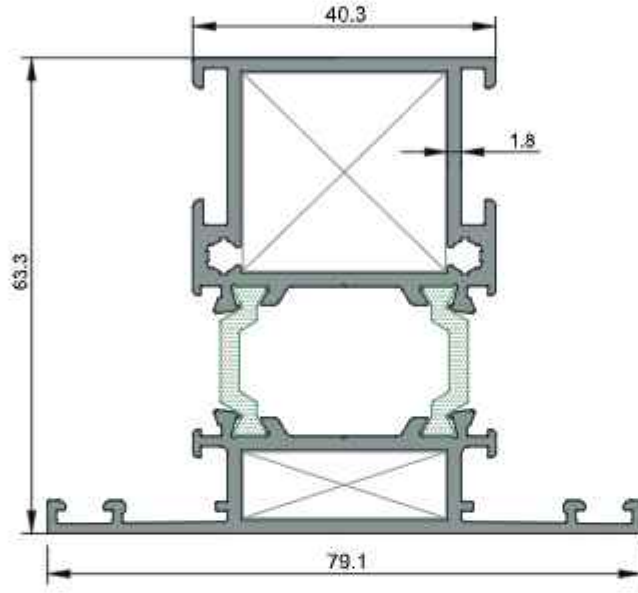

2651/52(1.8mm)
Geniş Orta Kayıt Profili
1,748 kg/m
Jx= 29,22 cm ⁴ Jy= 18,86 cm ⁴

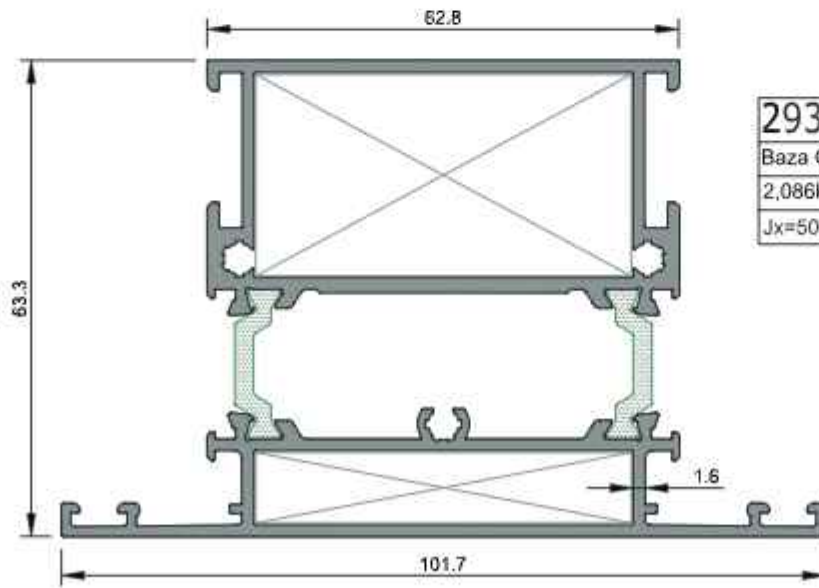

2933/34
Baza Orta Kayıt Profili
2,086kg/m
Jx=50,41 cm ⁴ Jy=35,25 cm ⁴

★ Yandaki profil birim ağırlıkları, bilgisayarla hesaplanmış teorik ağırlıklardır.

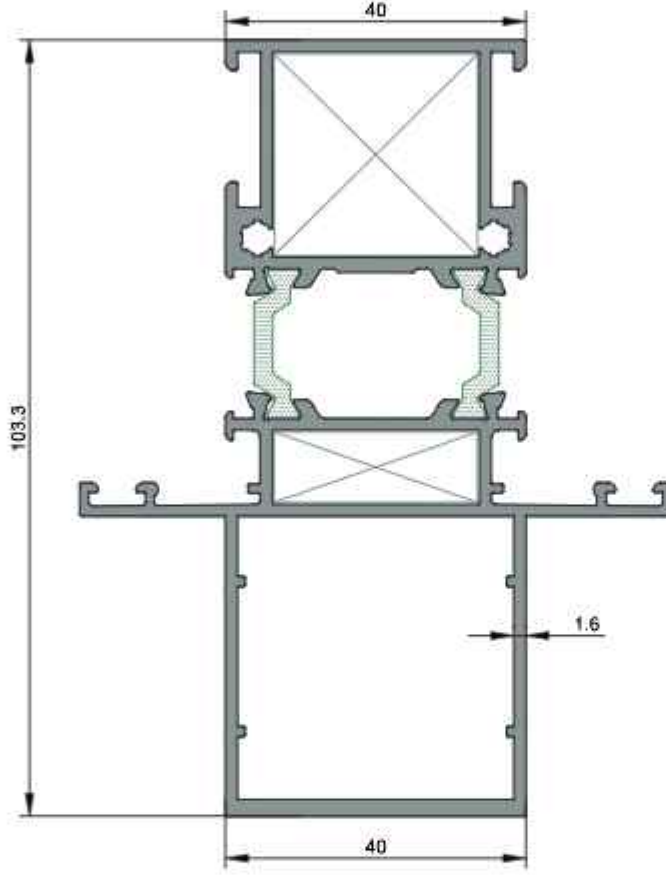

2651/4513

Takviyeli Orta Kayıt Profili

1,762 kg/m

$J_x=50,41 \text{ cm}^4$ $J_y=35,25 \text{ cm}^4$

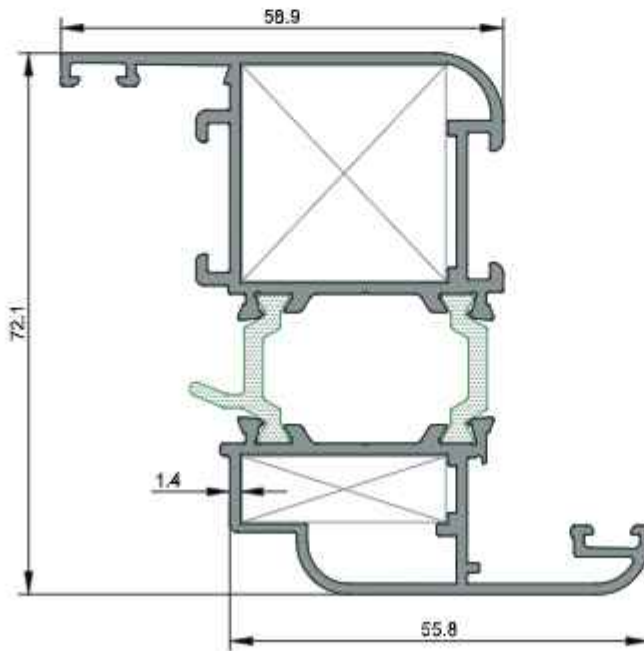

4720/4721

Oval Kanat Profili

1,586 kg/m

$J_x=39,38 \text{ cm}^4$ $J_y=13,64 \text{ cm}^4$

★ Yandaki profil birim ağırlıkları, bilgisayarla hesaplanmış teorik ağırlıklardır.

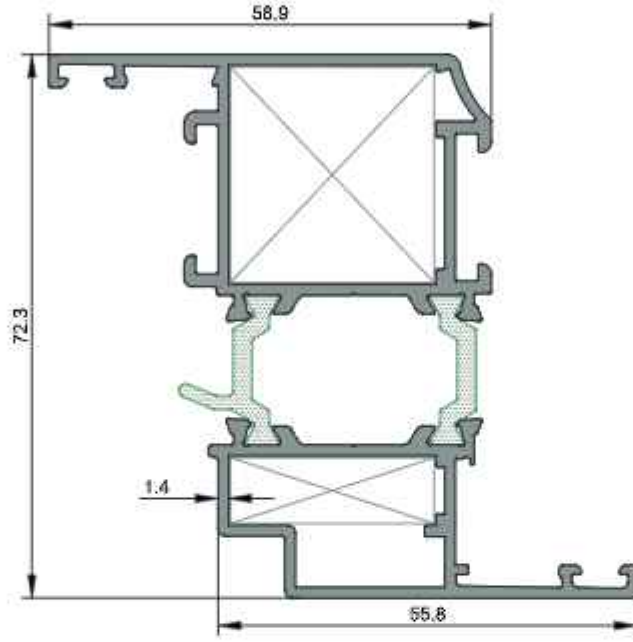

2653/54(1.4mm)
Geniş Kanat Profili
1,577 kg/m
Jx= 38,56 cm ⁴ Jy=13,53 cm ⁴

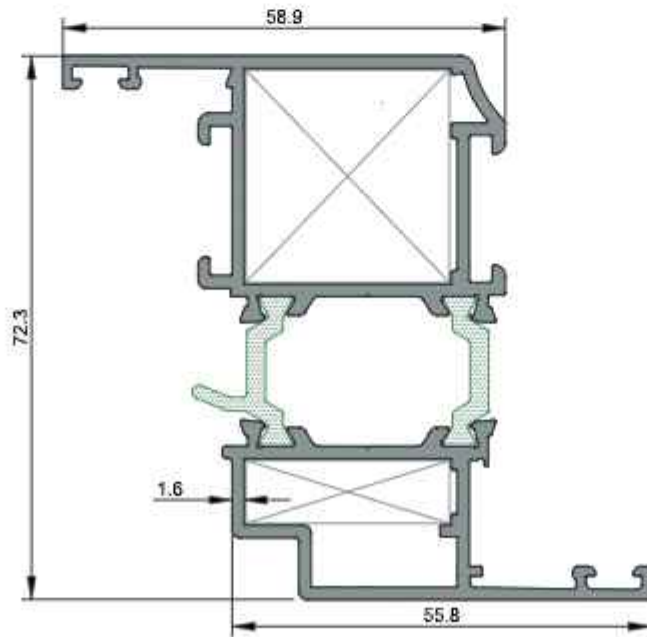

2653/54(1.6mm)
Geniş Kanat Profili
1,681 kg/m
Jx=40,63 cm ⁴ Jy=14,18 cm ⁴

★ Yandaki profil birim ağırlıkları, bilgisayarda hesaplanmış teorik ağırlıklardır.

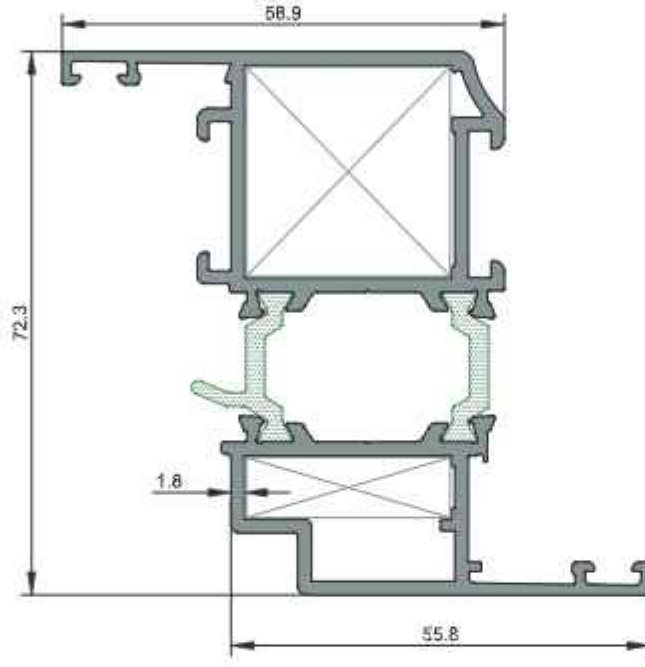

2653/54(1.8mm)
Geniş Kanat Profili
1,785 kg/m
Jx=42,74 cm ⁴ Jy=14,91 cm ⁴

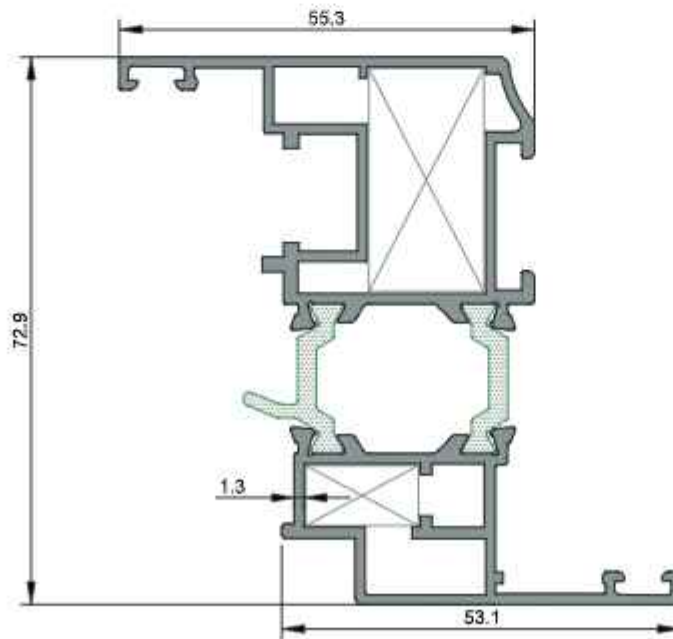

3478/79(1.3mm)
PVC Kanallı Pencere Kanadı
1,552 kg/m
Jx=36,72 cm ⁴ Jy=10,47 cm ⁴

★ Yandaki profil birim ağırlıkları, bilgisayarla hesaplanmış teorik ağırlıklardır.

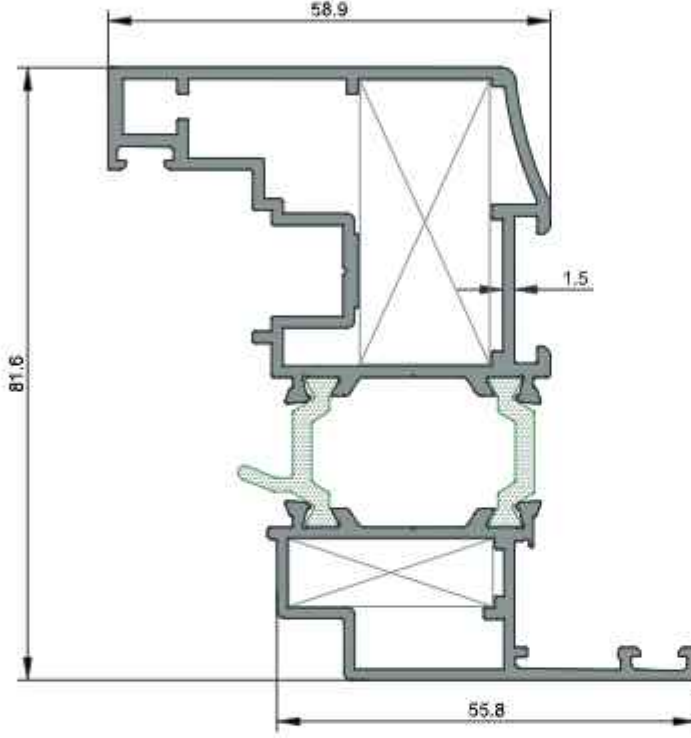

2932/2654
PVC Kanallı Pencere Kanadı
1,846 kg/m
Jx=56,91 cm ⁴ Jy=16,38 cm ⁴

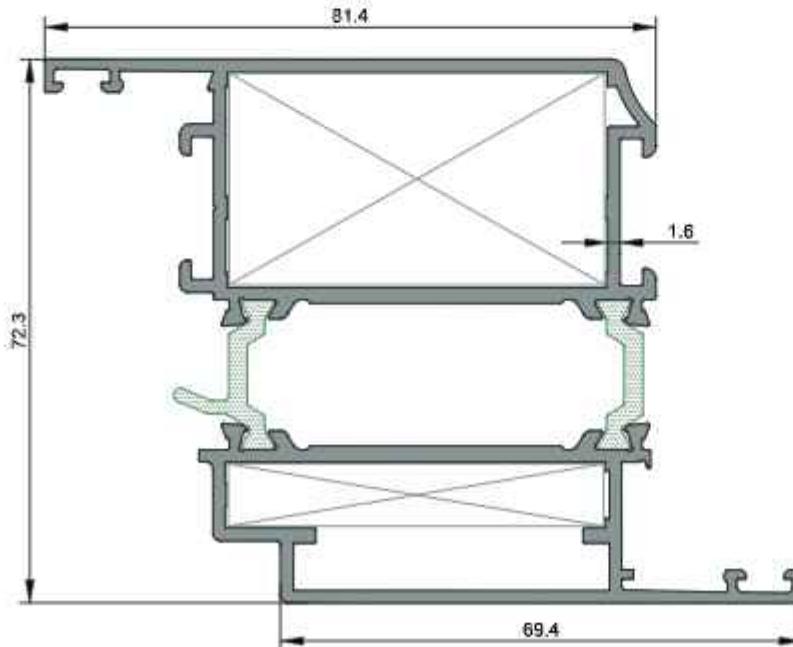

2661/62(1.6mm)
Kapı Kanat Profili
2,217 kg/m
Jx=62,91 cm ⁴ Jy=37,02 cm ⁴

★ Yandaki profil birim ağırlıkları, bilgisayarda hesaplanmış teorik ağırlıklardır.

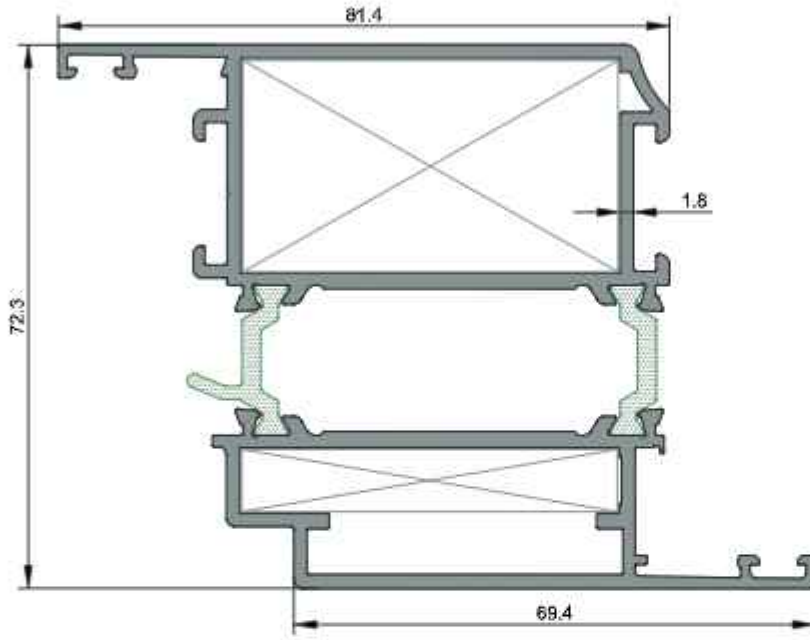

2661/62(1.8mm)
Kapı Kanat Profili
2,281 kg/m
Jx= 64,55 cm ⁴ Jy= 38,35 cm ⁴

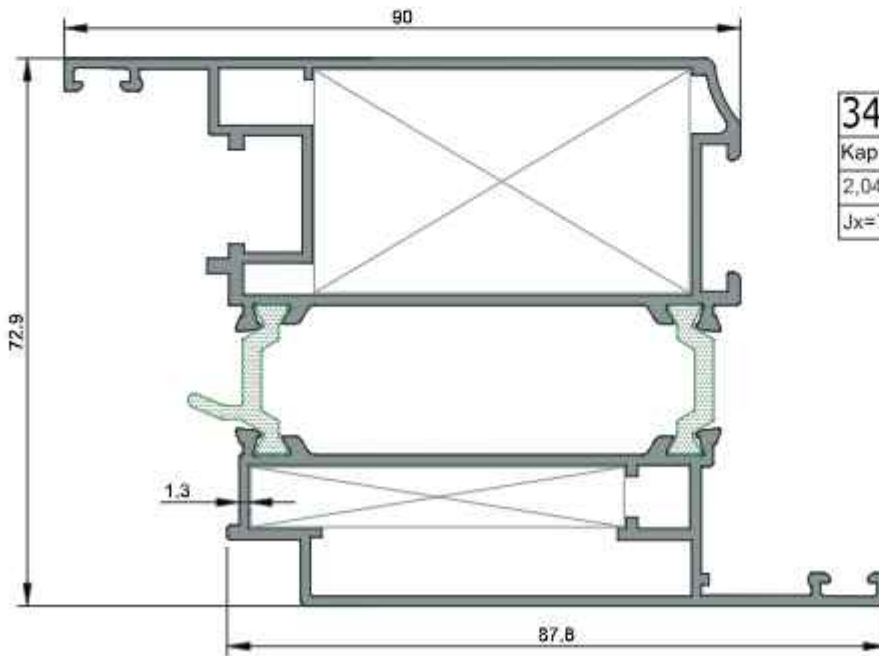

3483/84
Kapı Kanat Profili
2,047 kg/m
Jx=71,59 cm ⁴ Jy=37,78 cm ⁴

★ Yandaki profil birim ağırlıkları, bilgisayarla hesaplanmış teorik ağırlıklardır.

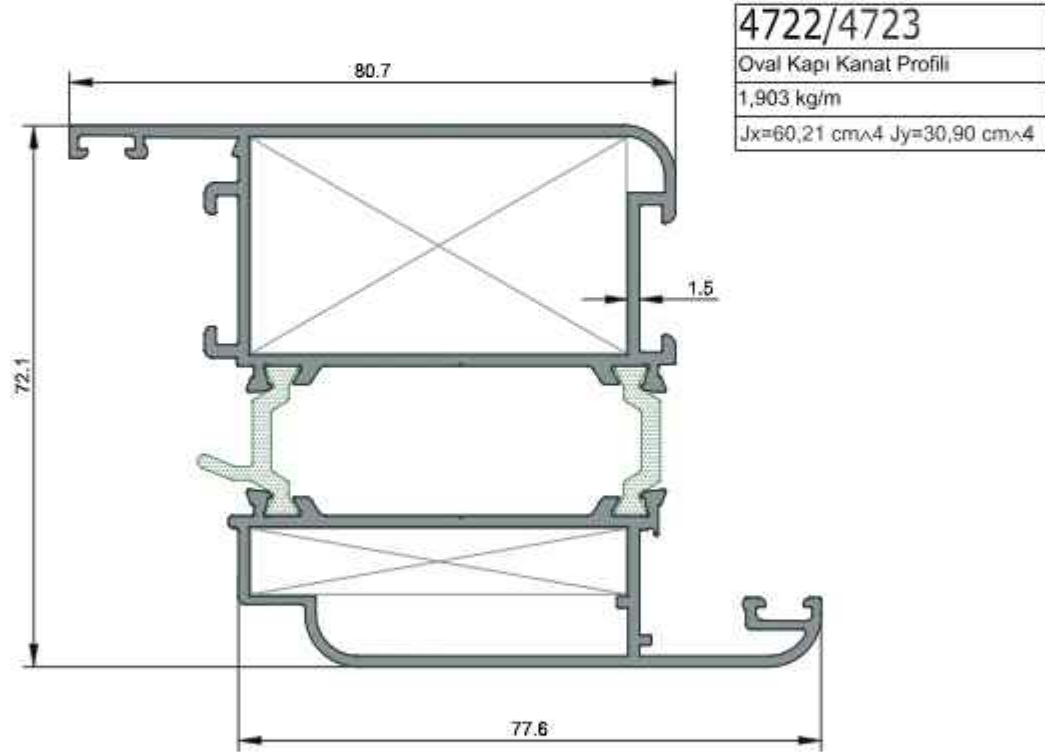

★ Yandaki profil birim ağırlıkları, bilgisayarda hesaplanmış teorik ağırlıklardır.

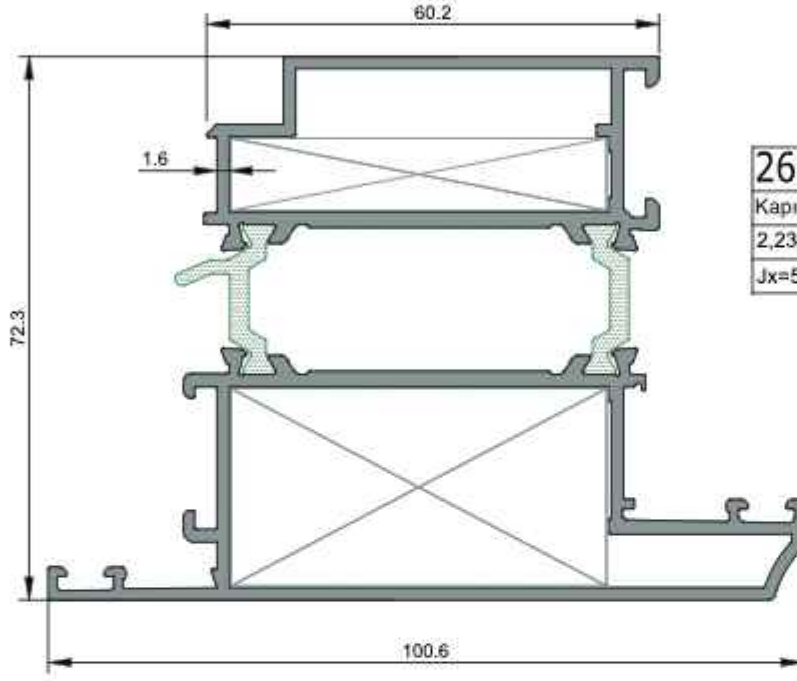

2663/64(1.6mm)
Kapı Kanat Profili(Dışa Açılır)
2,234 kg/m
Jx=56,05 cm ⁴ Jy=48,15 cm ⁴

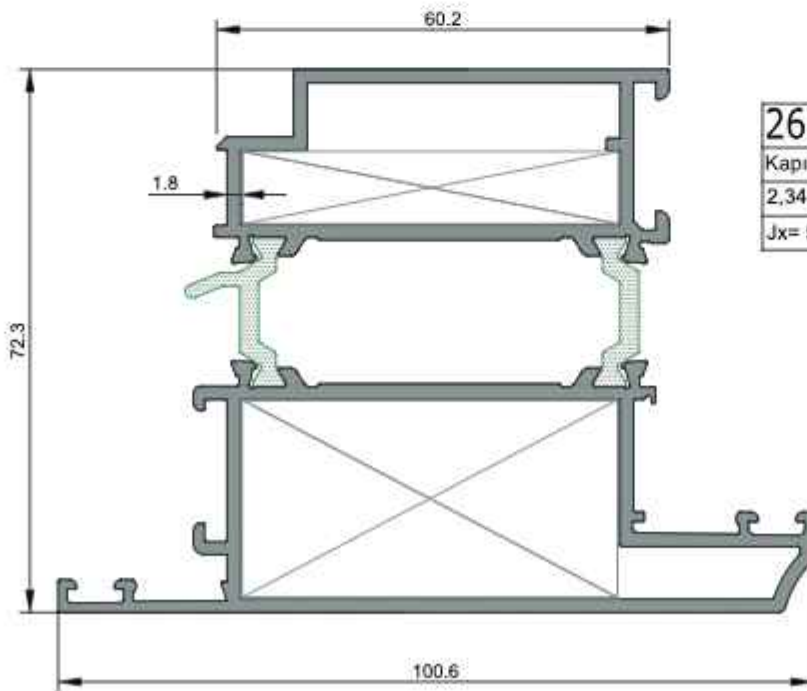

2663/64(1.8mm)
Kapı Kanat Profili(Dışa Açılır)
2,341 kg/m
Jx= 58,35 cm ⁴ Jy=51,56 cm ⁴

★ Yandaki profil birim ağırlıkları, bilgisayarla hesaplanmış teorik ağırlıklardır.

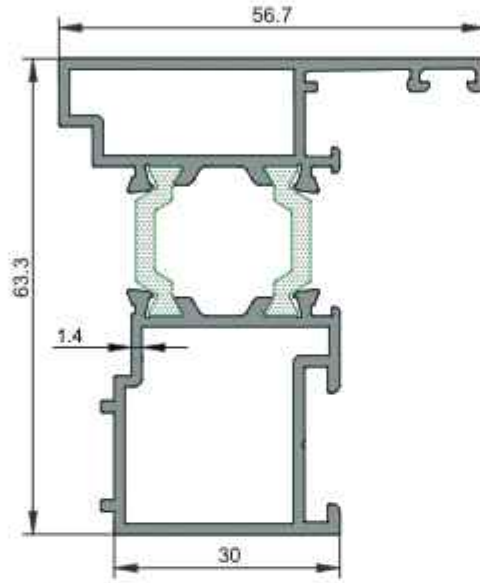

2659/60

Dışa Açılır

Çift Kanat Adaptörü

1,277 kg/m

$J_x=20,59 \text{ cm}^4$ $J_y=8,22 \text{ cm}^4$

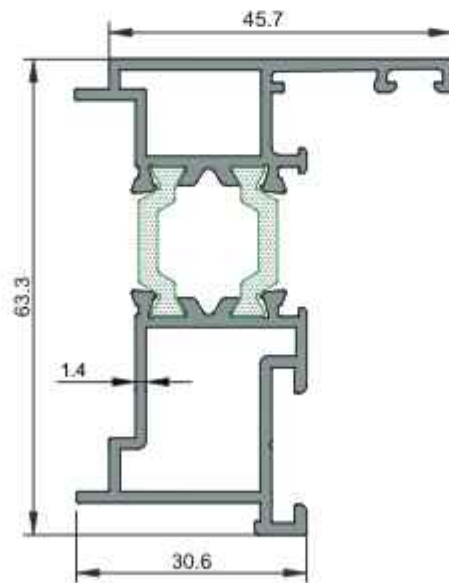

2655/56

Dışa Açılır Kapı Adaptörü

1,177 kg/m

$J_x=18,19 \text{ cm}^4$ $J_y=4,90 \text{ cm}^4$

★ Yandaki profil birim ağırlıkları, bilgisayarda hesaplanmış teorik ağırlıklardır.

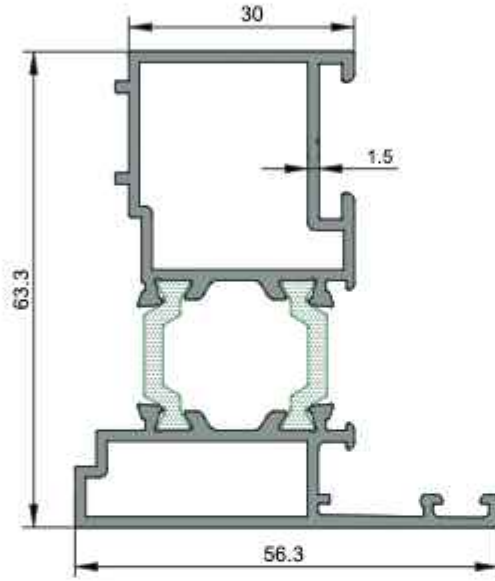

2815/16
İçe Açılır Çift Kanat Adaptörü
1,277 kg/m
$J_x=20,69 \text{ cm}^4$ $J_y=8,33 \text{ cm}^4$

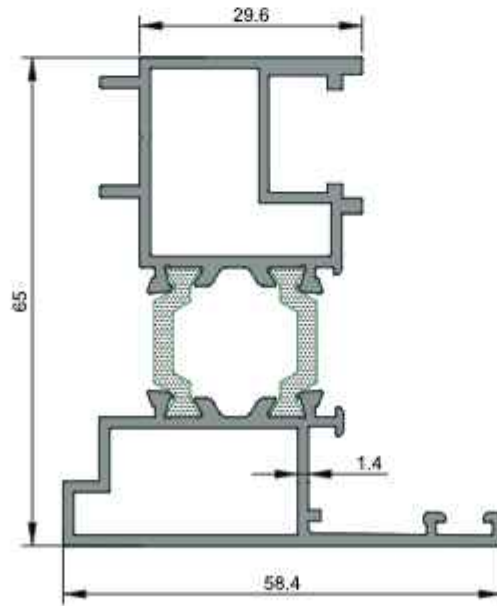

3556/57
PVC Kanallı Kanat Adaptör Profili
1,358 kg/m
$J_x=23,96 \text{ cm}^4$ $J_y=8,51 \text{ cm}^4$

★ Yandaki profil birim ağırlıkları, bilgisayarla hesaplanmış teorik ağırlıklardır.

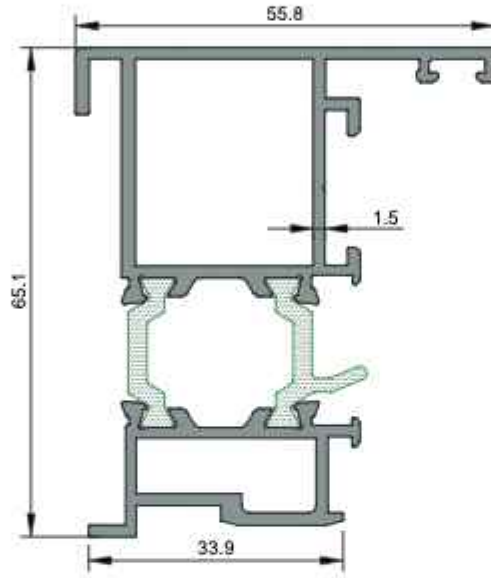

4899/4900

Pivot Kanat Adaptörü

1,404 kg/m

Jx=25,75 cm⁴ Jy=9,34 cm⁴

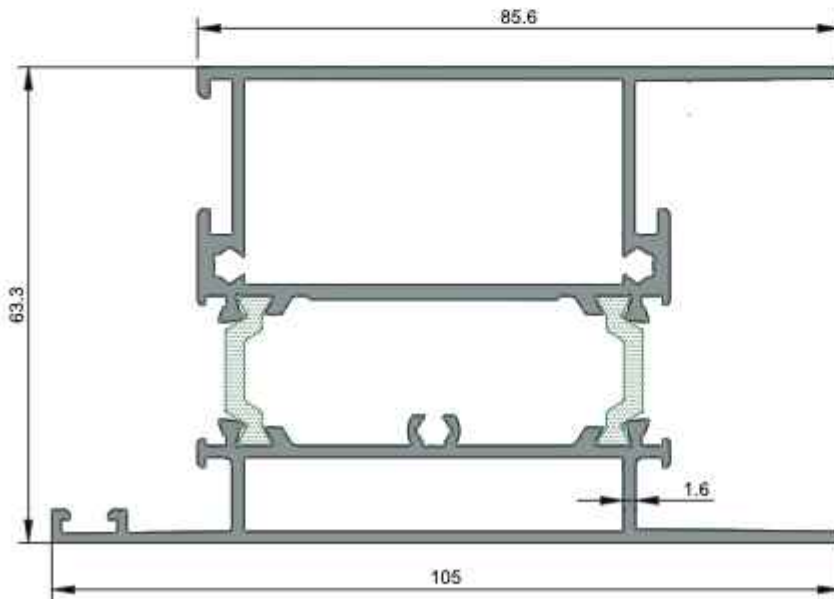

1909/10

Etek Profili

2,171 kg/m

Jx=57,72 cm⁴ Jy=38,24 cm⁴

★ Yandaki profil birim ağırlıkları, bilgisayarda hesaplanmış teorik ağırlıklardır.

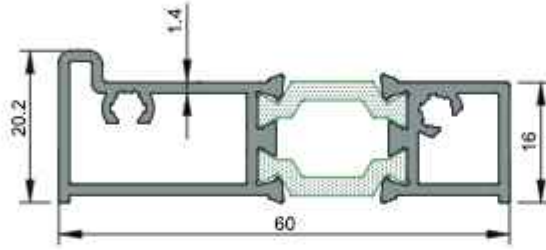

2935/36
Eşik Profili
0,861kg/m
Jx=11,31 cm ⁴ Jy=1,24 cm ⁴

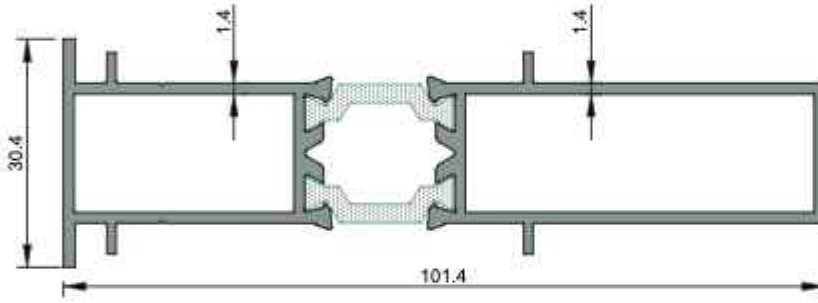

3141/42
Ek Profili
1,265 kg/m
Jx=43,16 cm ⁴ Jy=3,19 cm ⁴

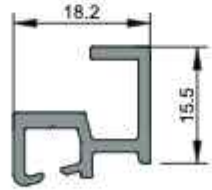

4120
Eşik-Kanat Adaptör Profili (İç)
0,245 kg/m

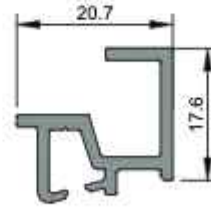

4121
Eşik-Kanat Adaptör Profili (Dış)
0,279 kg/m

★ Yandaki profil birim ağırlıkları, bilgisayarla hesaplanmış teorik ağırlıklardır.

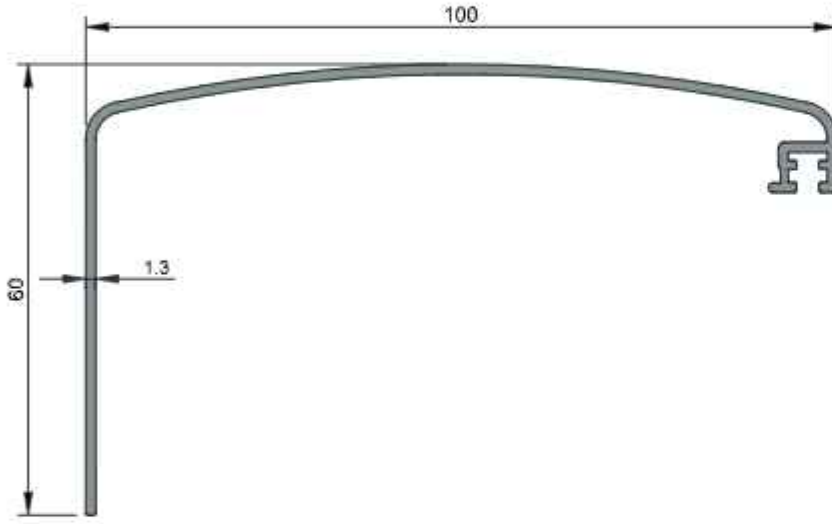

2260
Pervaz
0,625 kg/m

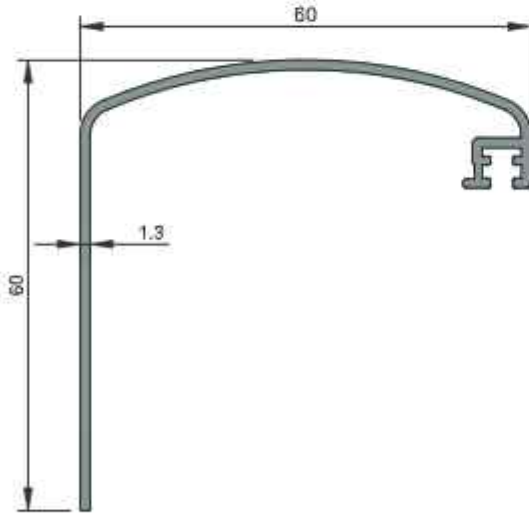

2259
Pervaz
0,486 kg/m

★ Yandaki profil birim ağırlıkları, bilgisayararda hesaplanmış teorik ağırlıklardır.

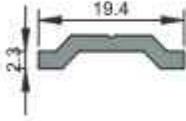

1210

İspanyolet Çubuğu
0,112 kg/m

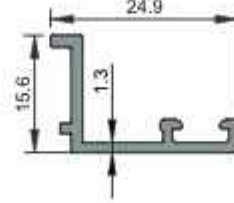

2666

Dış Tırnak
0,181 kg/m

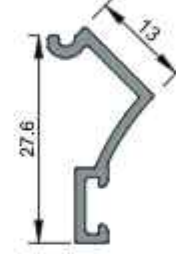

2667

Köşe Dönüş Adaptörü İç
0,179 kg/m

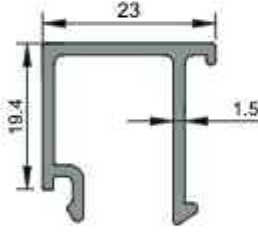

4124

Cam Çıtası
0,308 kg/m

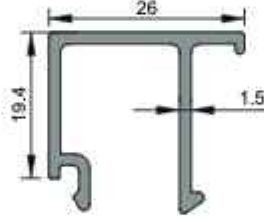

2668

Cam Çıtası
0,320 kg/m

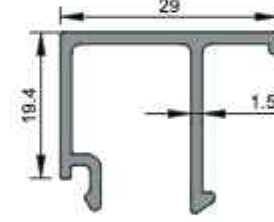

2657

Cam Çıtası
0,332 kg/m

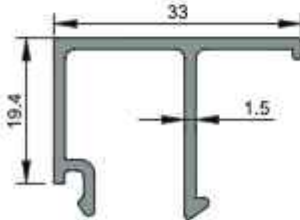

2914

Cam Çıtası
0,349 kg/m

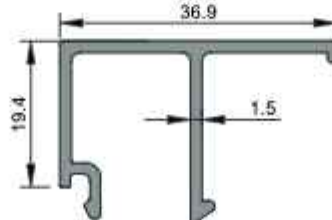

3136

Cam Çıtası
0,364 kg/m

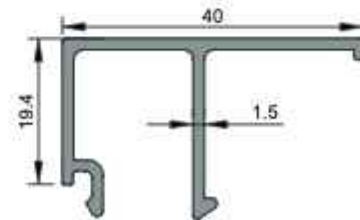

3183

Cam Çıtası
0,377 kg/m

★ Yandaki profil birim ağırlıkları, bilgisayarla hesaplanmış teorik ağırlıklardır.

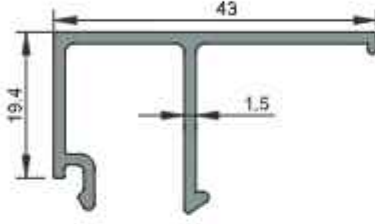

4122

Cam Çıtası
0,390 kg/m

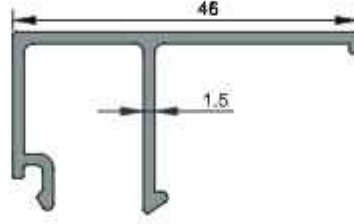

4123

Cam Çıtası
0,402 kg/m

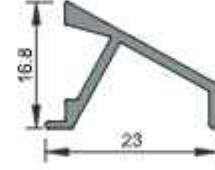

2181

Damlalık Profili
0,168 kg/m

★ Yandaki profil birim ağırlıkları, bilgisayarda hesaplanmış teorik ağırlıklardır.

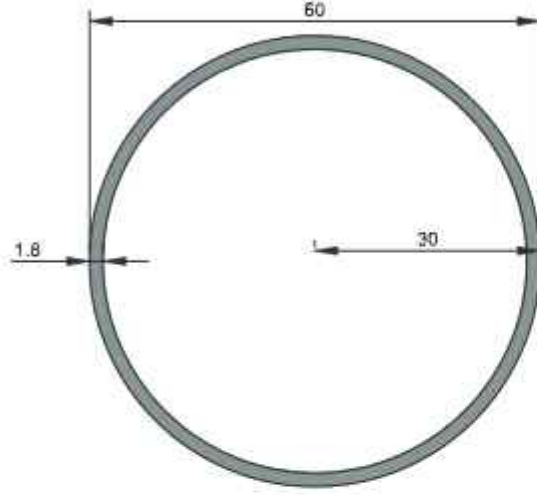

1980
60'luk Boru Profili
0,891 kg/m

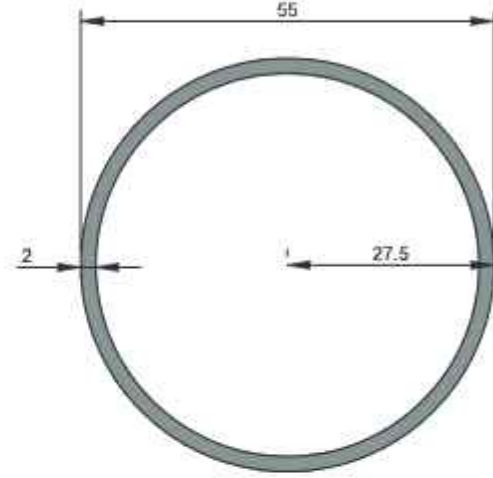

2150
55'lik Boru Profili
0,902 kg/m

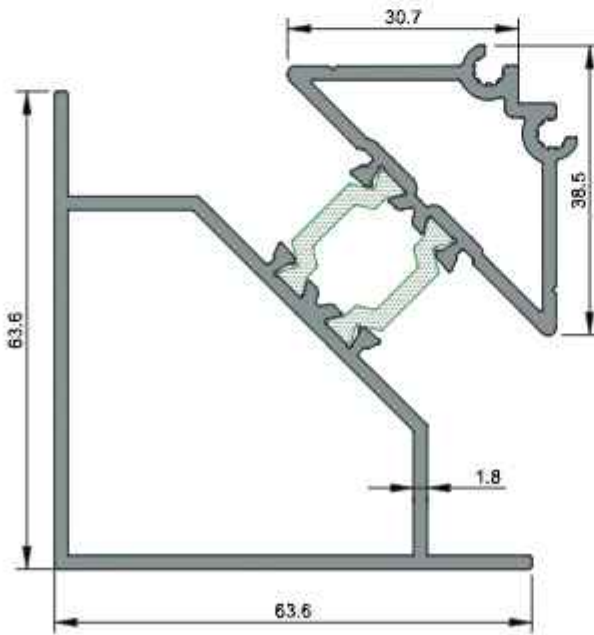

4733/34
Köşe Profili
1,863 kg/m
$J_x=39,43 \text{ cm}^4$ $J_y=25,11 \text{ cm}^4$

ÇEKTİRME TAKOZU KESİM ÖLÇÜLERİ

★ Yandaki profil birim ağırlıkları, bilgisayararda hesaplanmış teorik ağırlıklardır.

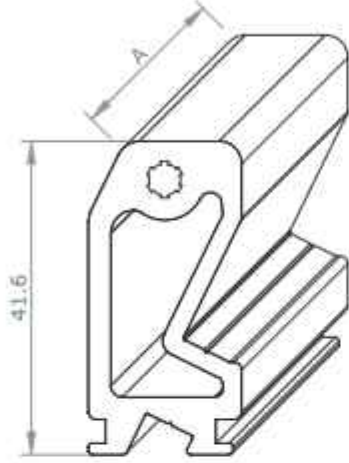

4125
Çektirme Takozu
1,099 kg/m

Aksesuar Kodu	Profil Kodu	Kesim Ölçüsü A(mm)
C4125 271	2651/52	27.1
C4125 173	2909/13	17.3

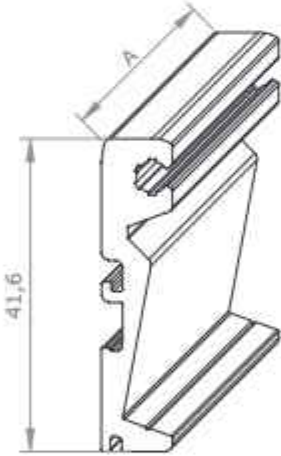

4133
Çektirme Takozu
0,566 kg/m

Aksesuar Kodu	Profil Kodu	Kesim Ölçüsü A(mm)
C4133 271	2651/52	27.1
C4133 173	2909/13	17.3

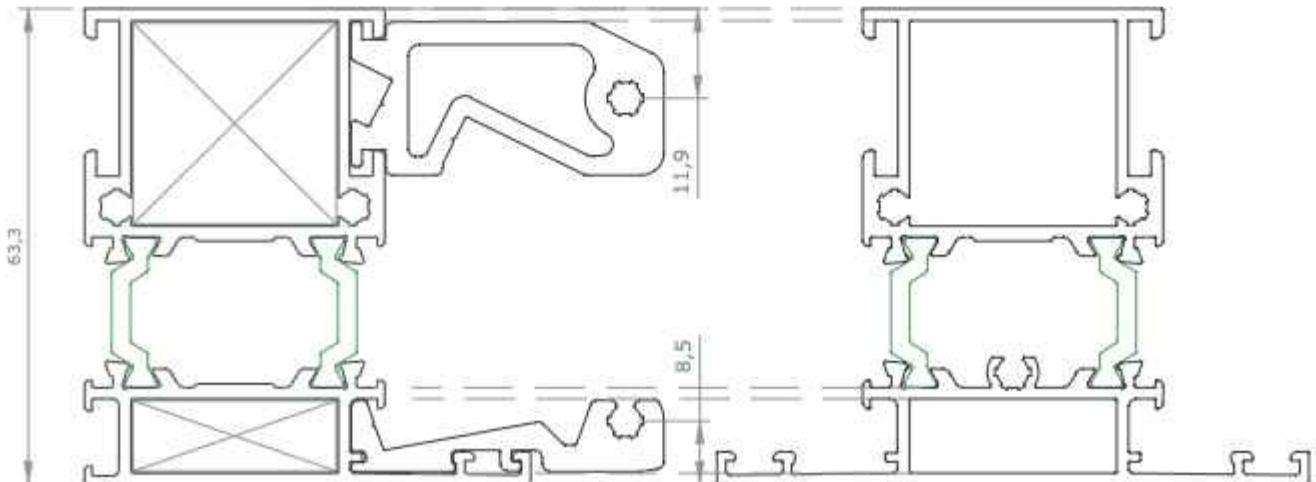

ORTA KAYIT KERTME DETAYI

★ Yandaki profil birim ağırlıkları, bilgisayarda hesaplanmış teorik ağırlıklardır.

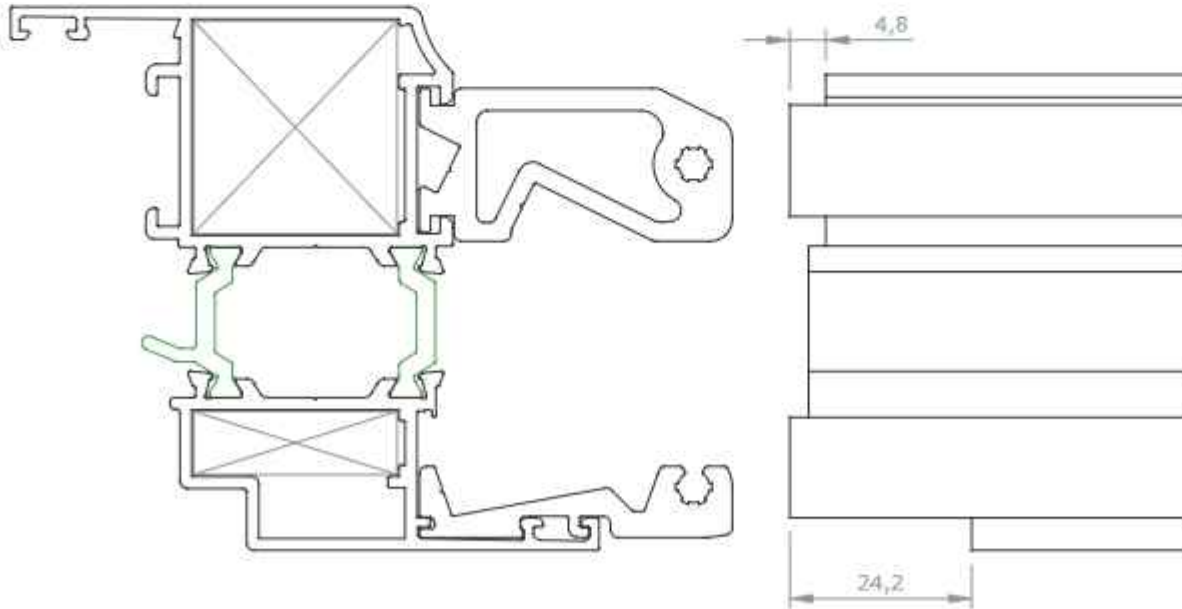
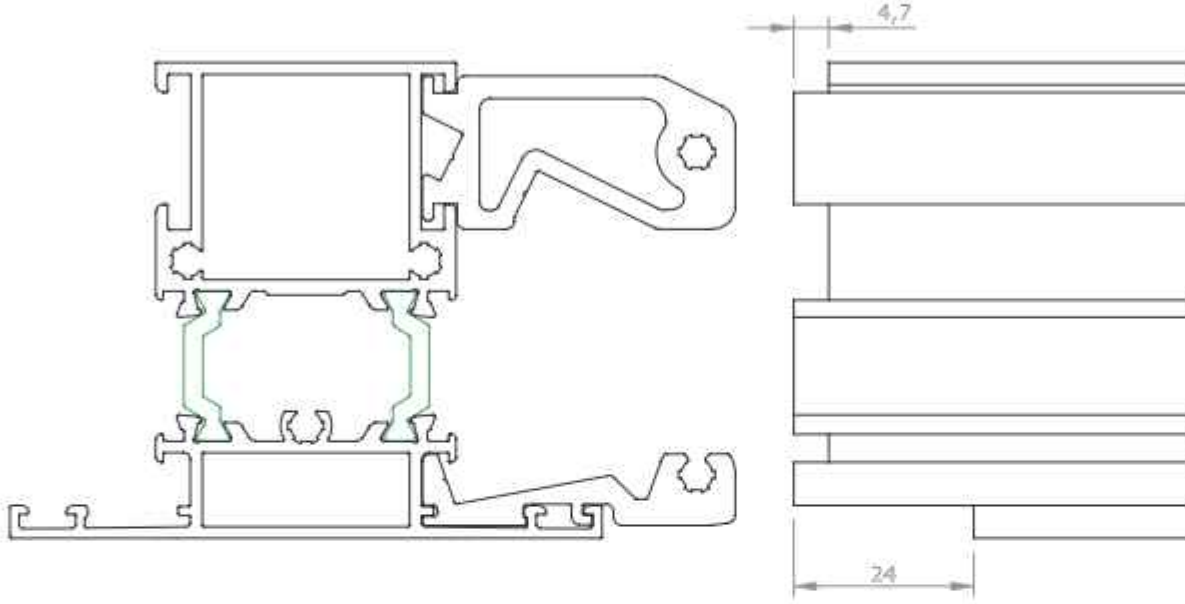

KÖŞE TAKOZU KESİM ÖLÇÜLERİ

3545

Köşe Takozu

4,616 kg/m

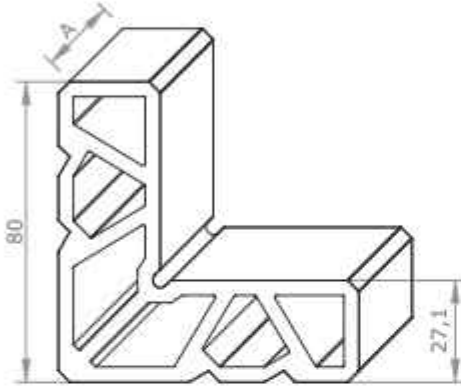

Aksesuar Kodu	Profil Kodu	Kesim Ölçüsü A(mm)
K3545 271	2650/2651-1,4	27.1
K3545 096	2650/2651-1,4	9.6
K3545 268	2650/2651-1,6	26.8
K3545 094	2650/2651-1,6	9.4
K3545 263	2650/2651-1,8	26.3
K3545 088	2650/2651-1,8	8.8
K3545 271	2651/2652-1,4	27.1
K3545 096	2651/2652-1,4	9.6
K3545 268	2651/2652-1,6	26.8
K3545 094	2651/2652-1,6	9.4
K3545 263	2651/2652-1,8	26.3
K3545 088	2651/2652-1,8	8.8
K3545 287	2653/2654-1,4	28.7
K3545 088	2653/2654-1,4	8.8
K3545 283	2653/2654-1,6	28.3
K3545 083	2653/2654-1,6	8.3
K3545 279	2653/2654-1,8	27.9
K3545 080	2653/2654-1,8	8.0
K3545 263	4452/4453-1,4	26.3
K3545 088	4452/4453-1,4	8.8
K3545 263	4452/4453-1,8	26.3
K3545 088	4452/4453-1,8	8.8
K3545 268	4718/4719	26.8
K3545 231	4718/4719	23.1
K3545 268	2651/4513	26.8
K3545 231	2651/4513	23.1
K3545 287	4720/4721	28.7
K3545 087	4720/4721	8.7
K3545 088	2654	8.8

2929

Köşe Takozu

3,341 kg/m

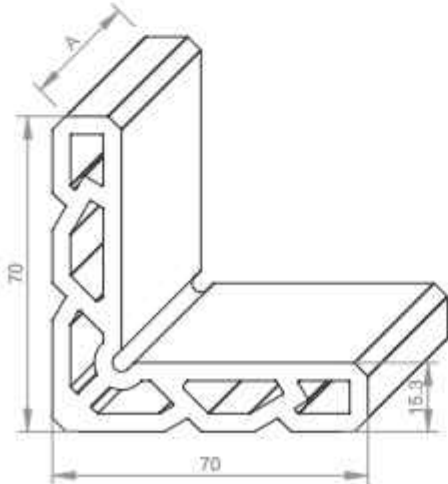

Aksesuar Kodu	Profil Kodu	Kesim Ölçüsü A(mm)
K2929 297	3478/3479	29.7
K2929 080	3478/3479	8.0

★ Yandaki profil birim ağırlıkları, bilgisayarda hesaplanmış teorik ağırlıklardır.

KÖŞE TAKOZU KESİM ÖLÇÜLERİ

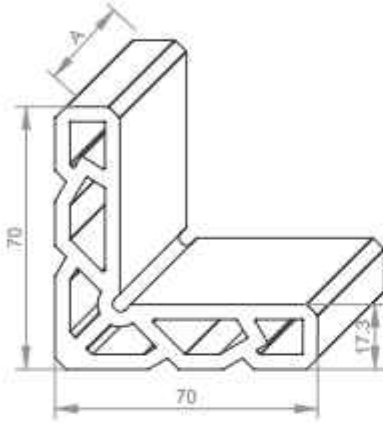

2917
Köşe Takozu
3,469 kg/m

Aksesuar Kodu	Profil Kodu	Kesim Ölçüsü A(mm)
K2917 268	2909/2910	26.8
K2917 094	2909/2910	9.4
K2917 268	2909/2913	26.8
K2917 094	2909/2913	9.4
K2917 283	2911/2912	28.3
K2917 083	2911/2912	8.3
K2917 377	2932	37.7

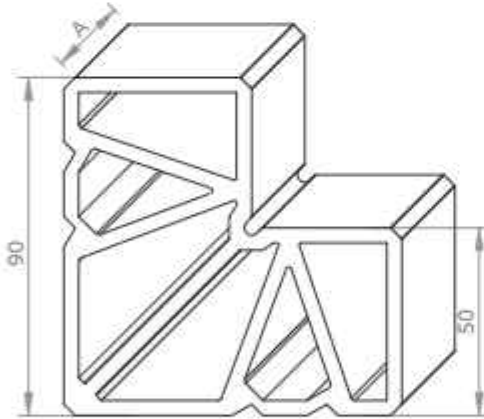

3546
Köşe Takozu
6,304 kg/m

Aksesuar Kodu	Profil Kodu	Kesim Ölçüsü A(mm)
K3546 263	2663/2664-1,6	26.3
K3546 096	2663/2664-1,6	9.6
K3546 261	2663/2664-1,8	26.1
K3546 094	2663/2664-1,8	9.4
K3546 283	2661/2662-1,6	28.3
K3546 083	2661/2662-1,6	8.3
K3546 284	2661/2662-1,8	28.4
K3546 085	2661/2662-1,8	8.5
K3546 297	3483/3484	29.7
K3546 080	3483/3484	8.0
K3546 268	2933/2934	26.8
K3546 080	2933/2934	8.0
K3546 377	4722/4723	37.7
K3546 088	4722/4723	8.8

★ Yandaki profil birim ağırlıkları, bilgisayarda hesaplanmış teorik ağırlıklardır.

ÖLÇEK:1/1

CAMLAMA SEÇENEK TABLOSU

★ Yandaki profil birim ağırlıkları, bilgisayarda hesaplanmış teorik ağırlıklardır.

	Cam Kalınlığı - Cam Çıtası Yüksekliği	Fibri Kodu	Profil
5	46	HL 07	4123
6		HL 04	
7		HL 31	
8	43	HL 07	4122
9		HL 04	
10		HL 31	
11	40	HL 07	3183
12		HL 04	
13		HL 31	
14	36.9	HL 07	3136
15		HL 04	
16		HL 31	
18	33	HL 07	2914
19		HL 04	
20		HL 31	
22	29	HL 07	2657
23		HL 04	
24		HL 31	
25	26	HL 07	2668
26		HL 04	
27		HL 31	
28	23	HL 07	4124
29		HL 04	
30		HL 31	

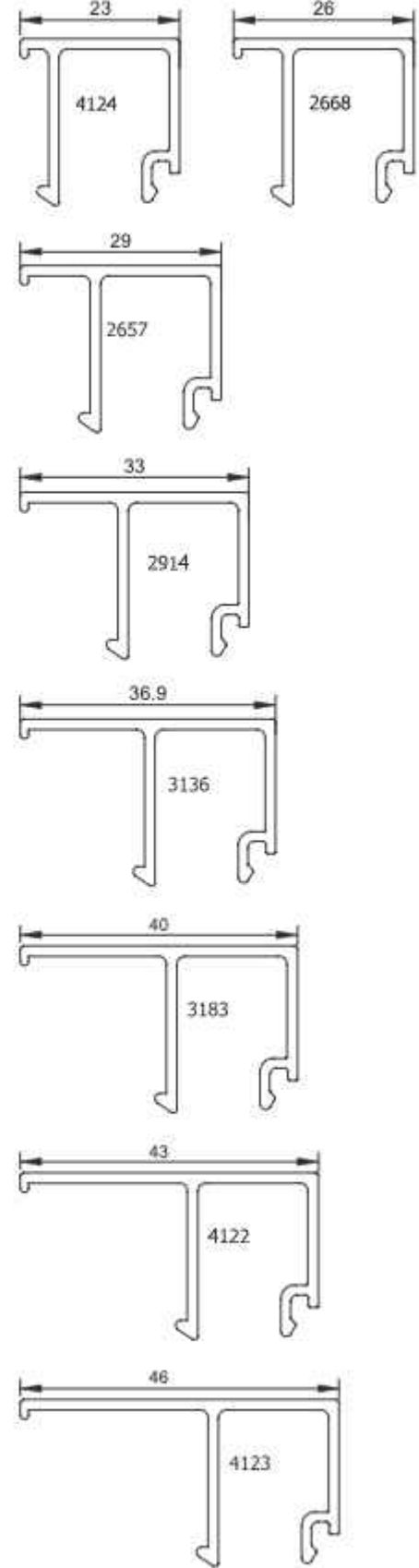

ÖLÇEK:1/1

CAMLAMA SEÇENEK TABLOSU

★ Yandaki profil birim ağırlıkları, bilgisayarda hesaplanmış teorik ağırlıklardır.

Cam Kalınlığı - Cam Çıtası Yüksekliği	Fitil Kodu	Profil
46	HL 07	4123
	HL 04	
	HL 31	
43	HL 07	4122
	HL 04	
	HL 31	
40	HL 07	3183
	HL 04	
	HL 31	
36.9	HL 07	3136
	HL 04	
	HL 31	
33	HL 07	2914
	HL 04	
	HL 31	
29	HL 07	2657
	HL 04	
	HL 31	
26	HL 07	2668
	HL 04	
	HL 31	
23	HL 07	4124
	HL 04	
	HL 31	

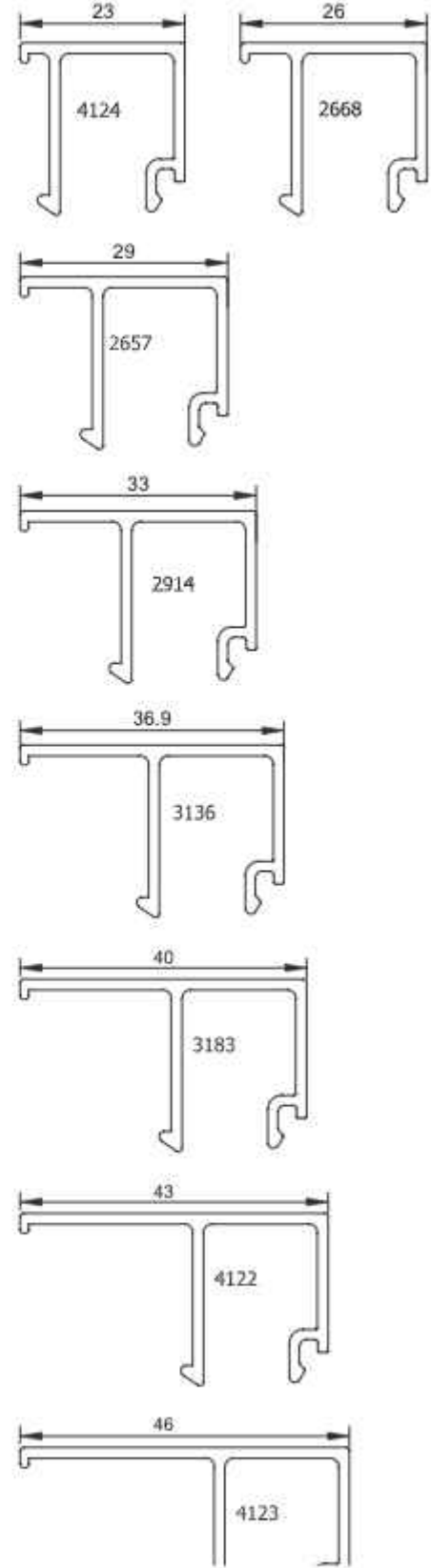

ÖLÇEK:1/1

CAMLAMA SEÇENEK TABLOSU

★ Yandaki profil birim ağırlıkları, bilgisayarda hesaplanmış teorik ağırlıklardır.

Cam Kalınlığı - Cam Çıtası Yüksekliği	Fital Kodu	Profil																					
			8	9	10	11	12	13	14	15	16	18	19	20	22	23	24	25	26	27	28		
40	HL 07	3183																					
	HL 04																						
	HL 31																						
36,9	HL 07	3136																					
	HL 04																						
	HL 31																						
33	HL 07	2914																					
	HL 04																						
	HL 31																						
29	HL 07	2657																					
	HL 04																						
	HL 31																						
26	HL 07	2668																					
	HL 04																						
	HL 31																						
23	HL 07	4124																					
	HL 04																						
	HL 31																						
21,2	HL 07	4756																					
	HL 04																						
	HL 31																						

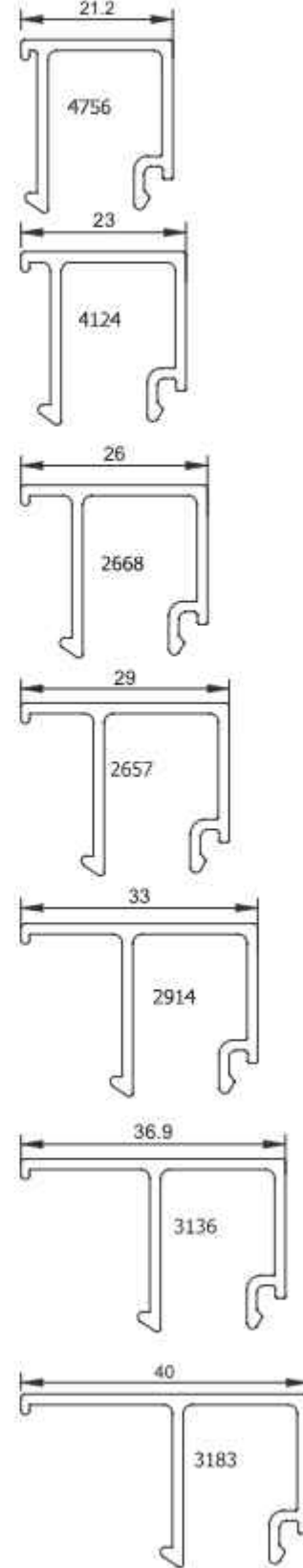

PENCERE UYGULAMA TİPLERİ

★ Yandaki profil birim ağırlıkları, bilgisayarda hesaplanmış teorik ağırlıklardır.

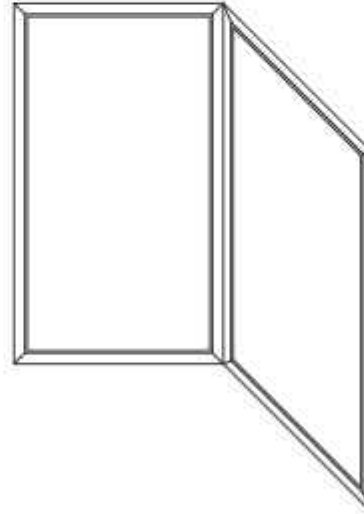
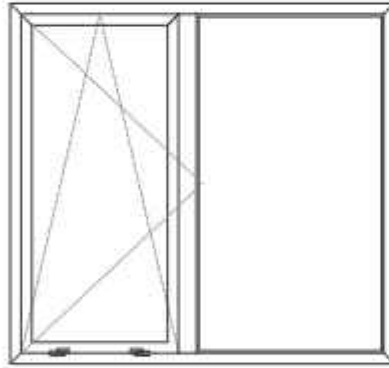
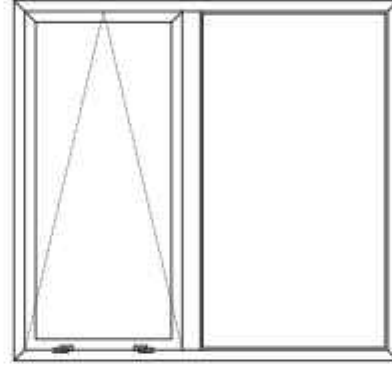
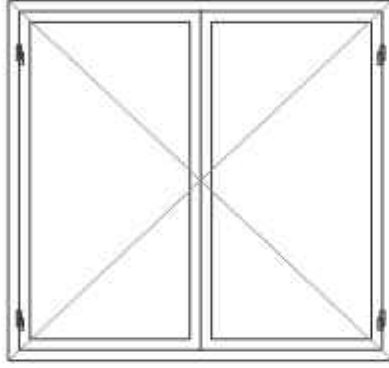

DETAY- 1a
ÖLÇEK:1/1

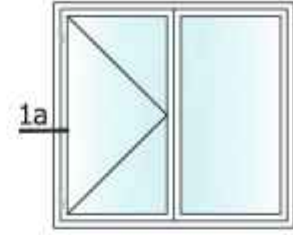

★ Yandaki profil birim ağırlıkları, bilgisayarla hesaplanmış teorik ağırlıklardır.

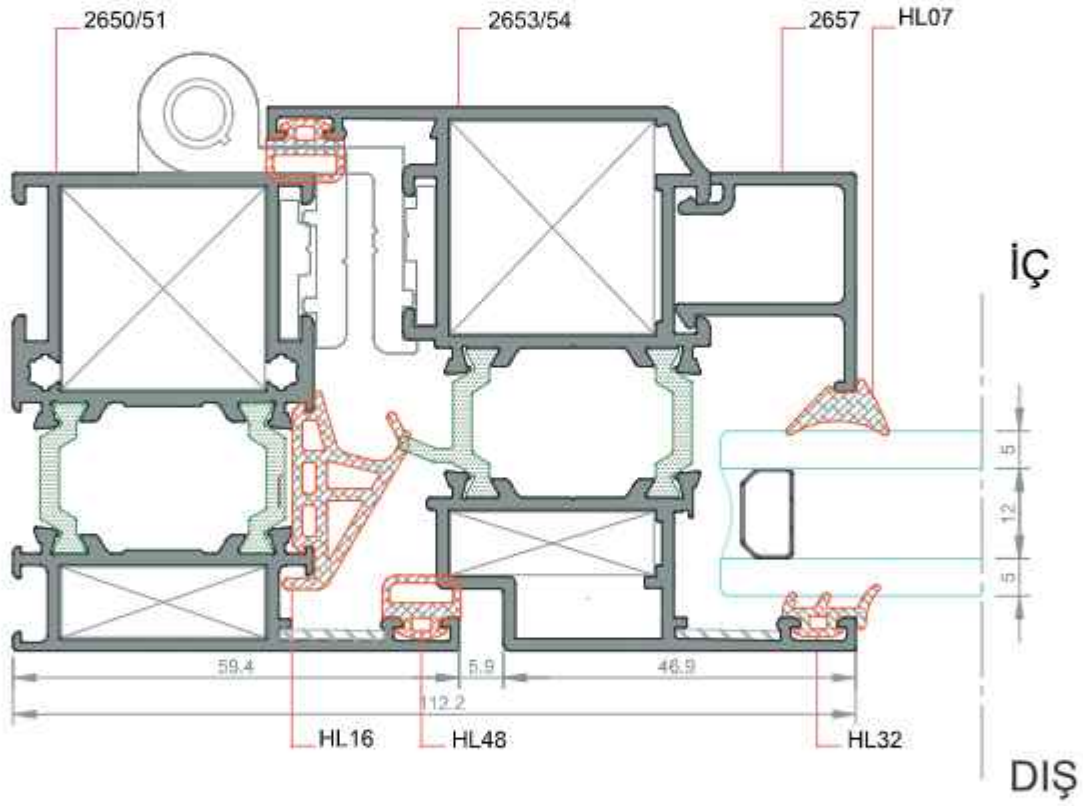

DETAY- 1b
ÖLÇEK:1/1

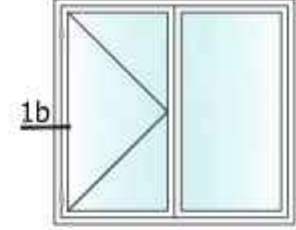

★ Yandaki profil birim ağırlıkları, bilgisayarla hesaplanmış teorik ağırlıklardır.

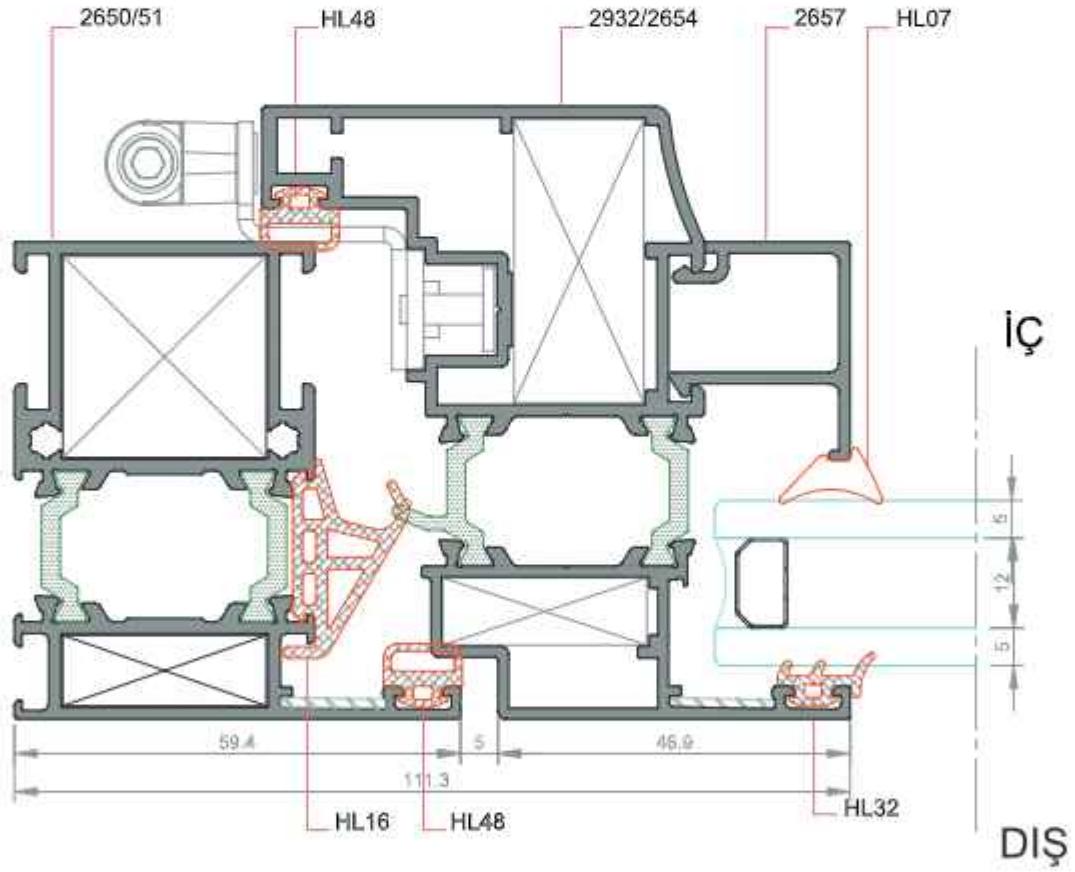

DETAY- 1c
ÖLÇEK:ÖLÇEKSİZ

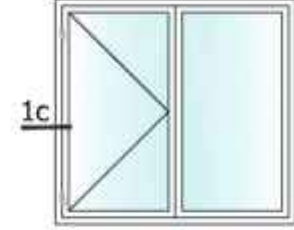

★ Yandaki profil birim ağırlıkları, bilgisayarda hesaplanmış teorik ağırlıklardır.

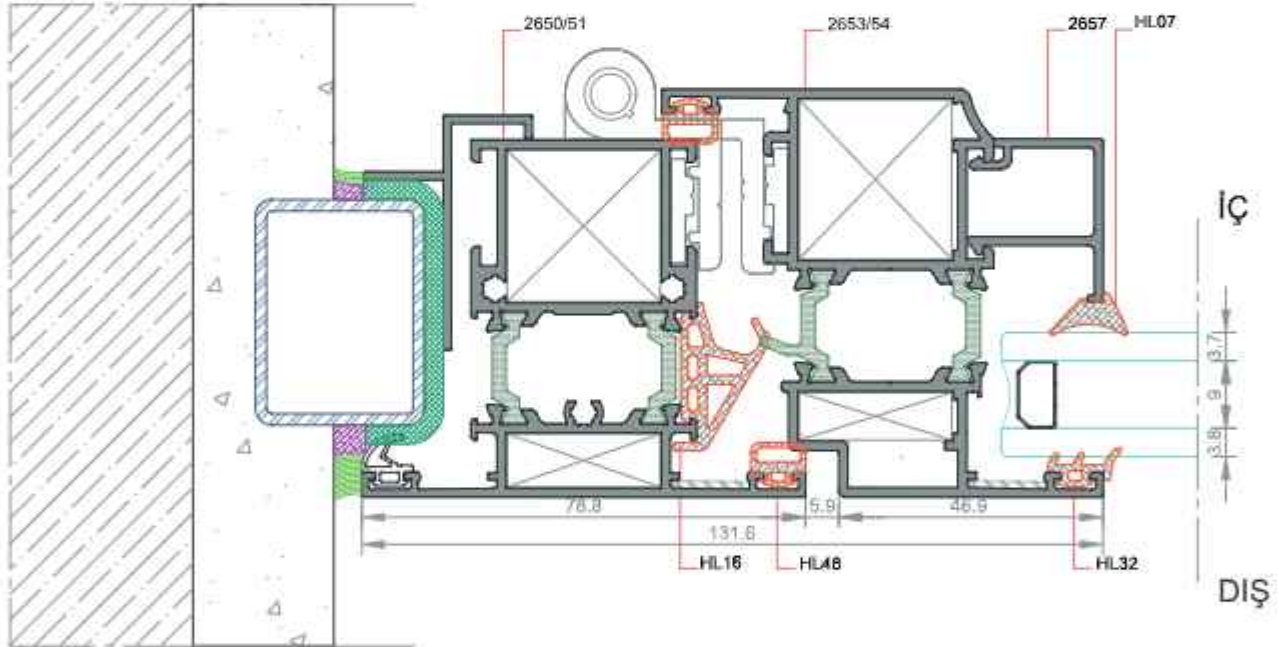

DETAY- 1d
ÖLÇEK:1/1

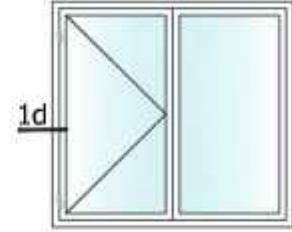

★ Yandaki profil birim ağırlıkları, bilgisayarda hesaplanmış teorik ağırlıklardır.

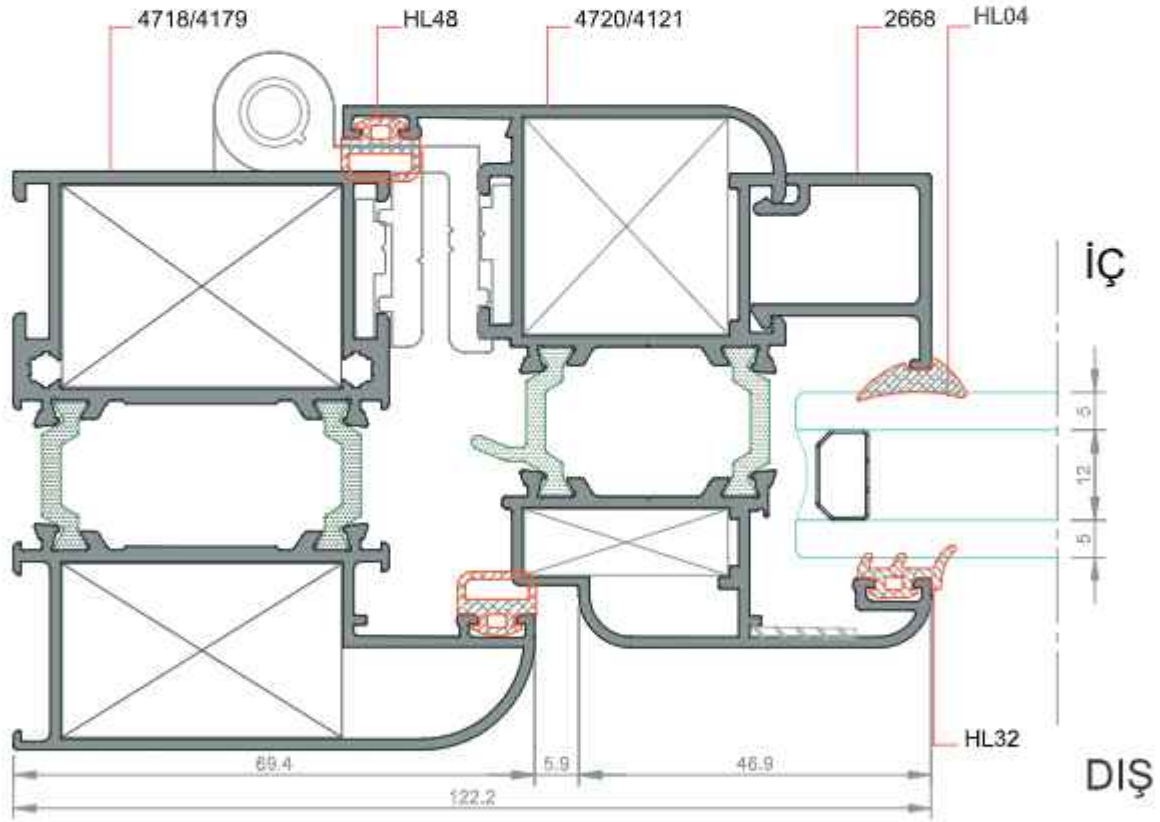

DETAY-1e
ÖLÇEK: ÖLÇEKSİZ

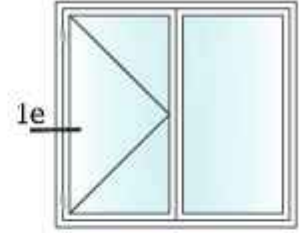

★ Yandaki profil birim ağırlıkları, bilgisayarla hesaplanmış teorik ağırlıklardır.

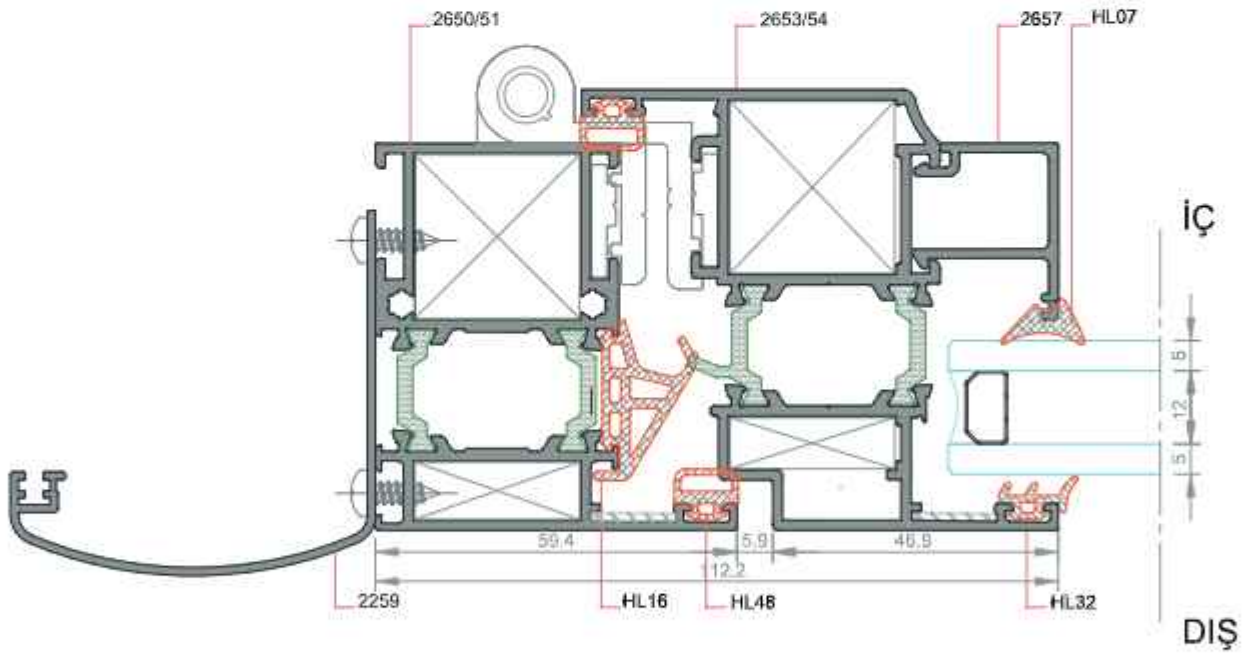

DETAY- 2
ÖLÇEK:1/1

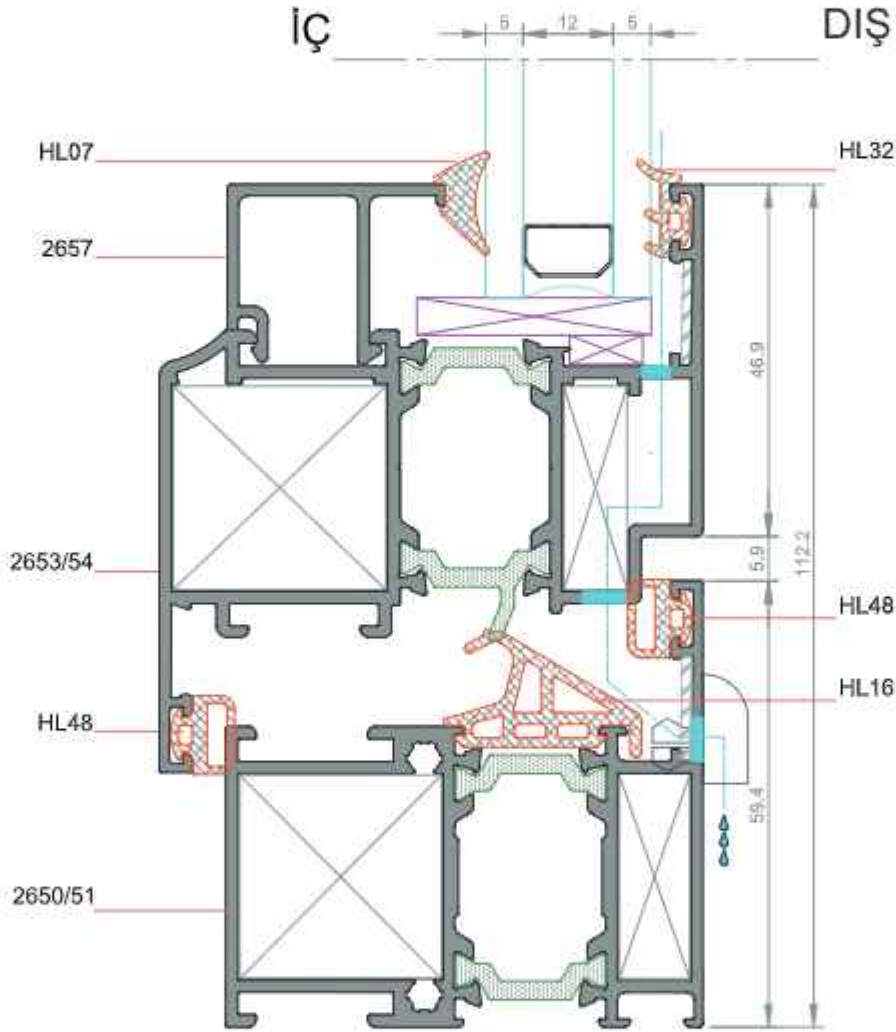
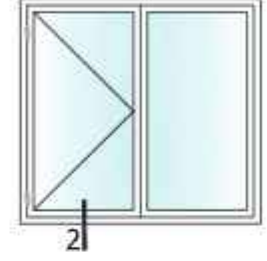

★ Yandaki profil ağırlıkları, bilgisayarla hesaplanmış teorik ağırlıklardır.

DETAY- 3
ÖLÇEK:1/1

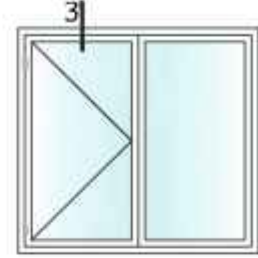

★ Yandaki profil birim ağırlıkları, bilgisayarla hesaplanmış teorik ağırlıklardır.

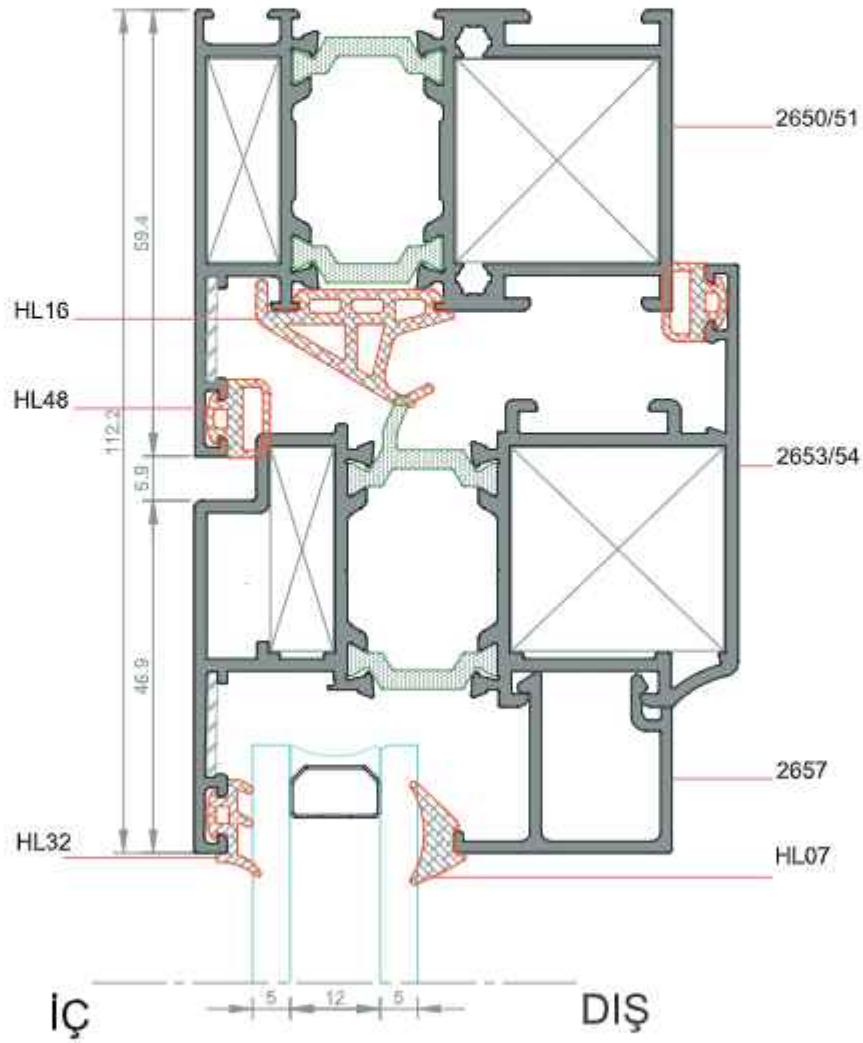

DETAY- 4
ÖLÇEK:1/1

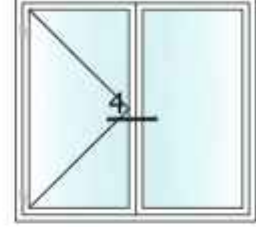

★ Yandaki profil birim ağırlıkları, bilgisayarda hesaplanmış teorik ağırlıklardır.

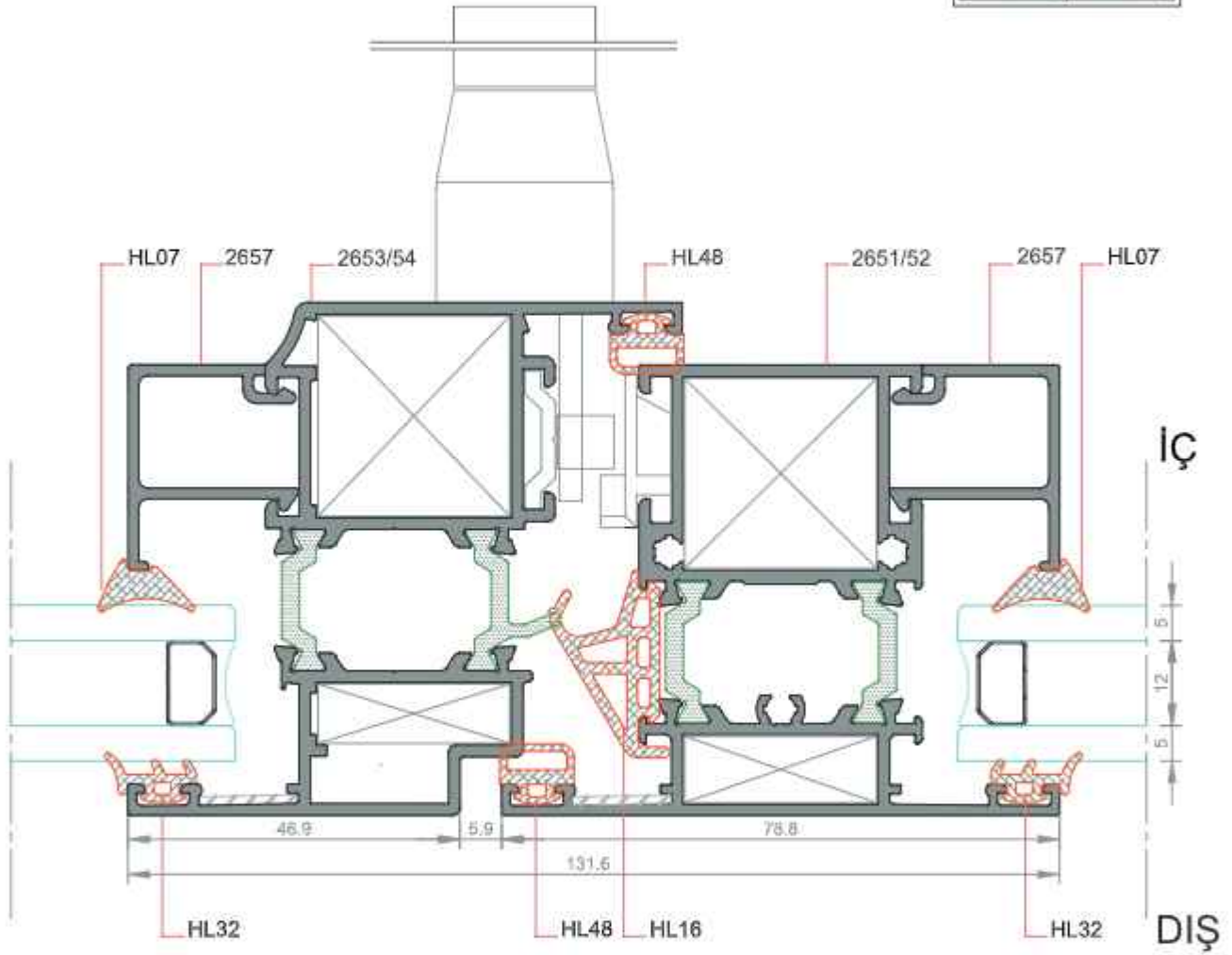

DETAY- 4a
ÖLÇEK:1/1

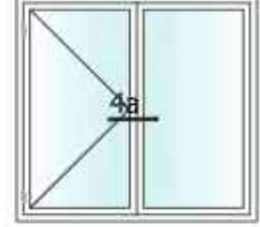

★ Yandaki profil birim ağırlıkları, bilgisayarda hesaplanmış teorik ağırlıklardır.

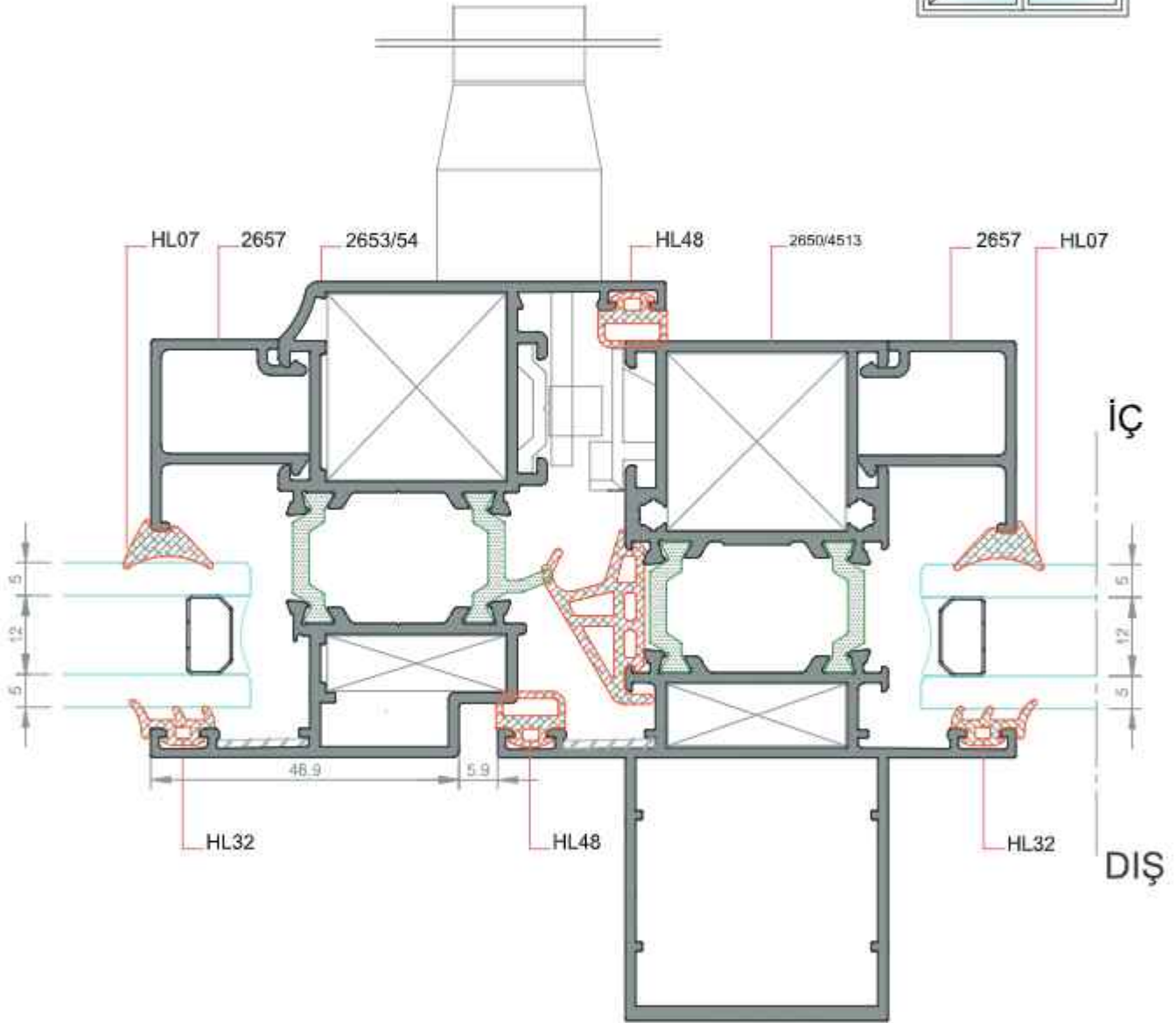

DETAY- 5
ÖLÇEK:1/1

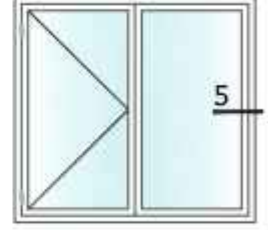

★ Yandaki profil birim ağırlıkları, bilgisayarla hesaplanmış teorik ağırlıklardır.

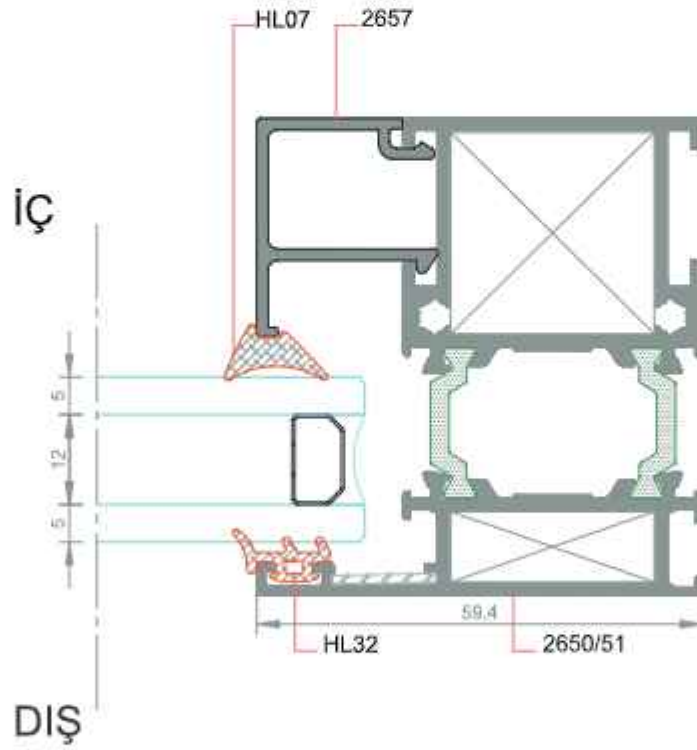

DETAY- 1
ÖLÇEK:1/1

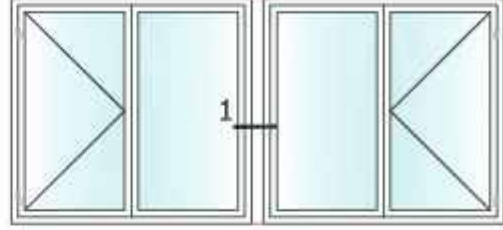

★ Yandaki profil birim ağırlıkları, bilgisayarda hesaplanmış teorik ağırlıklardır.

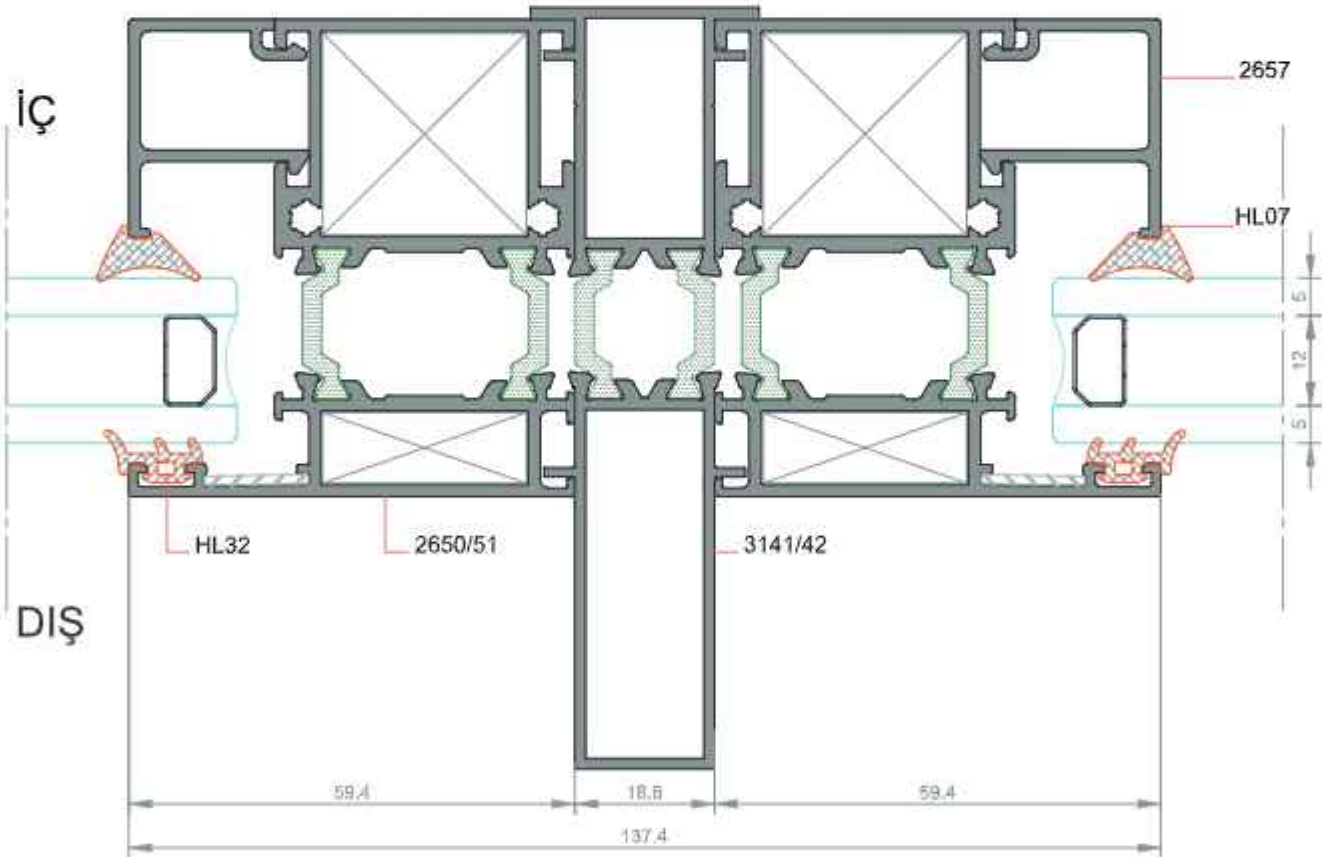

DETAY- 1a
ÖLÇEK:1/1

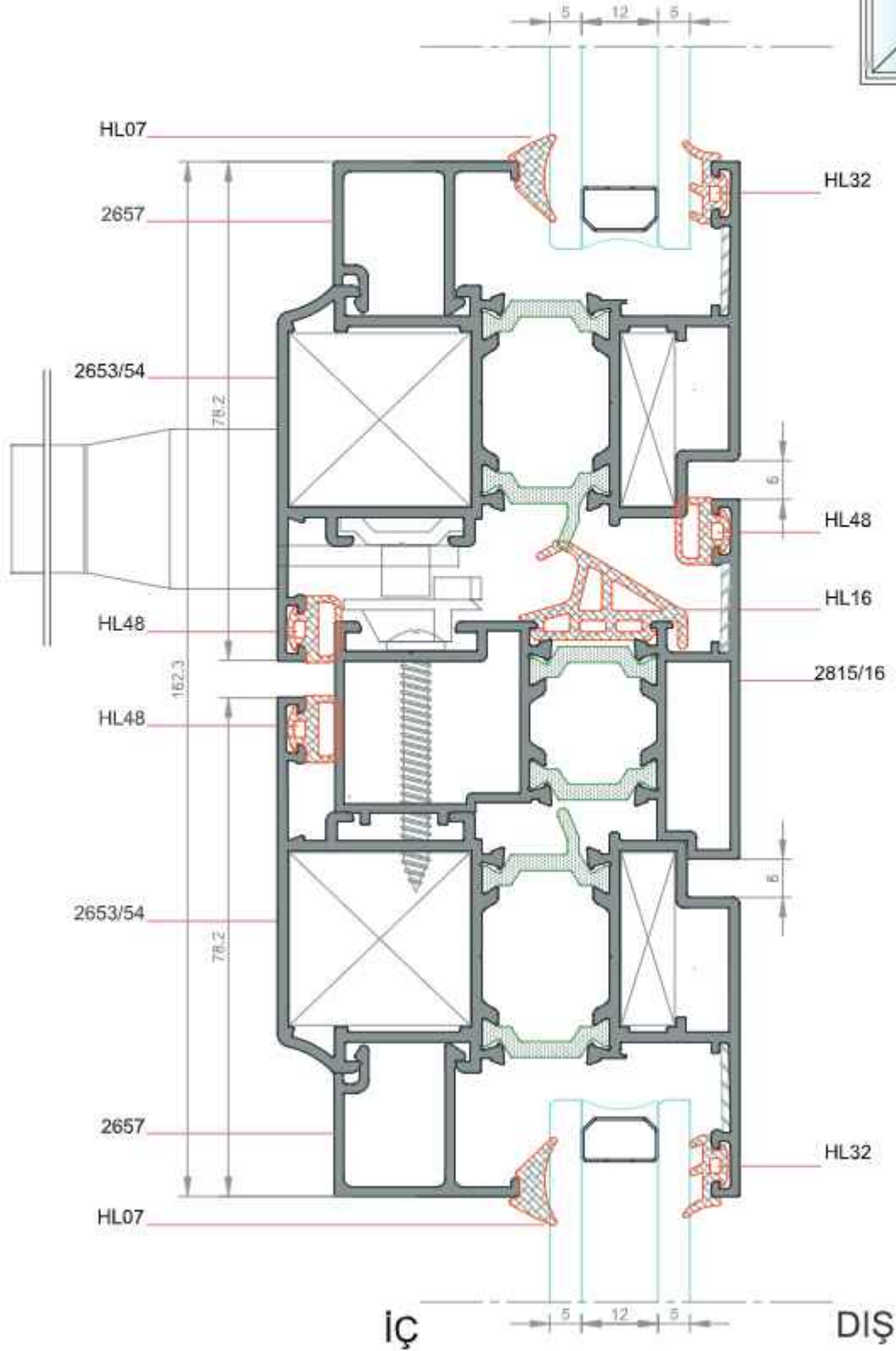
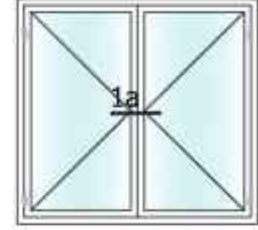

★ Yandaki profil birim ağırlıkları, bilgisayarda hesaplanmış teorik ağırlıklardır.

DETAY- 1b
ÖLÇEK:1/1

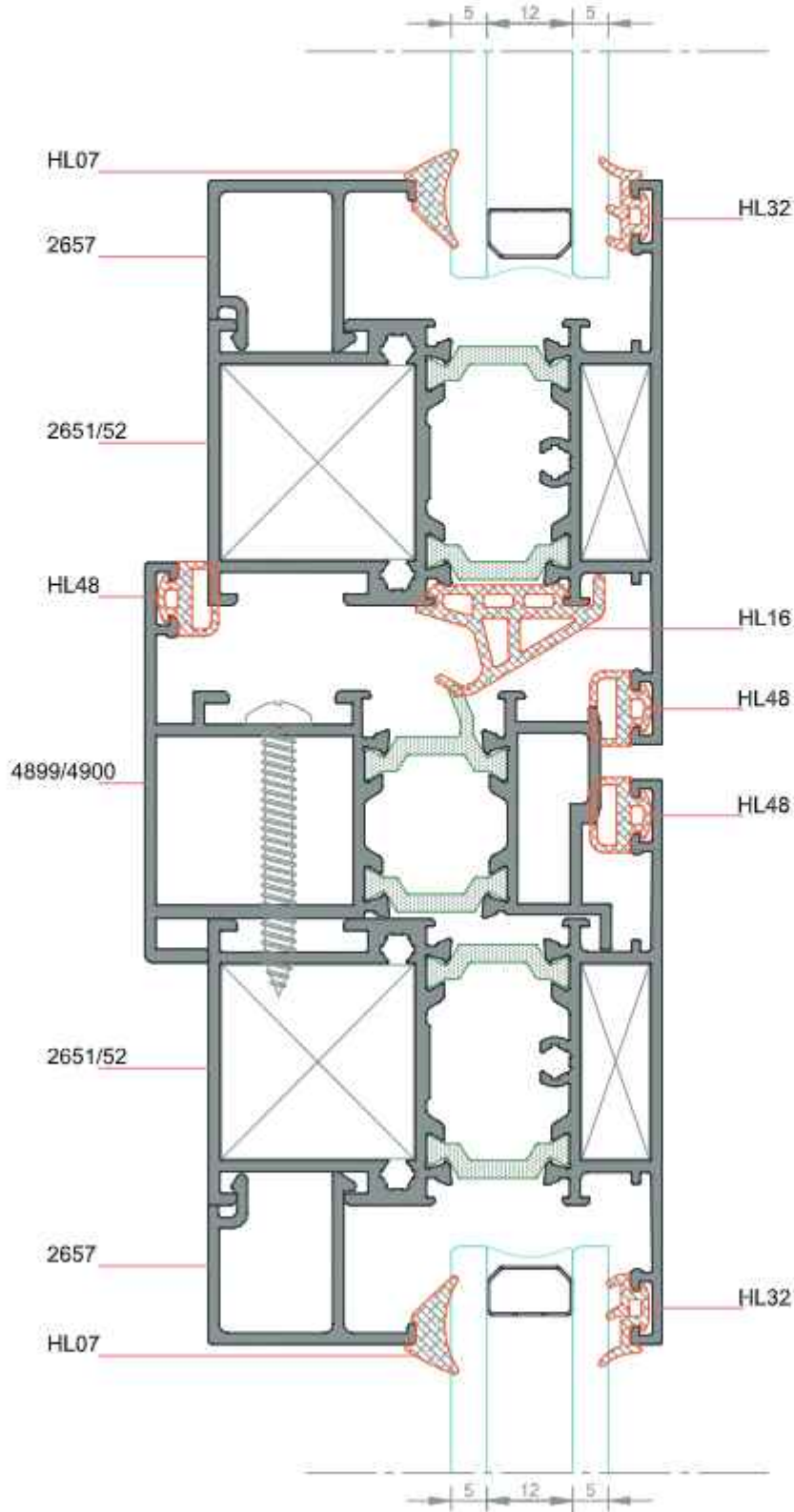
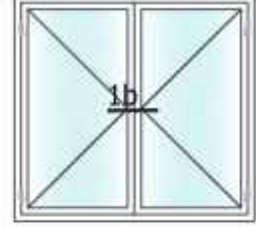

★ Yandaki profil birim ağırlıkları, bilgisayarla hesaplanmış teorik ağırlıklardır.

DETAY- 1c
ÖLÇEK:1/1

★ Yandaki profil birim ağırlıkları, bilgisayarda hesaplanmış teorik ağırlıklardır.

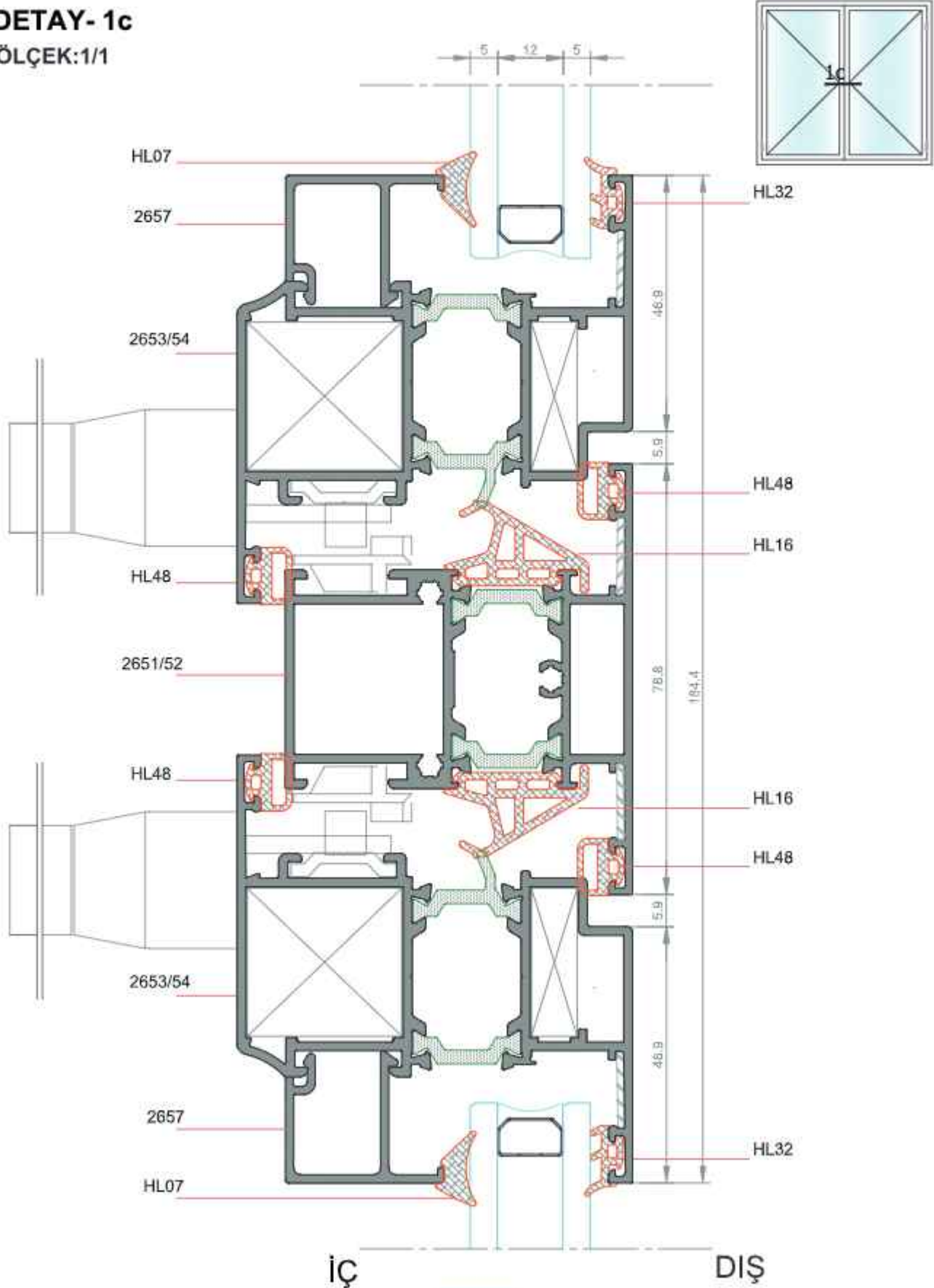

DETAY- 1
ÖLÇEK:1/1

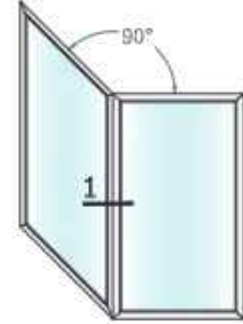

★ Yandaki profil birim ağırlıkları, bilgisayarla hesaplanmış teorik ağırlıklardır.

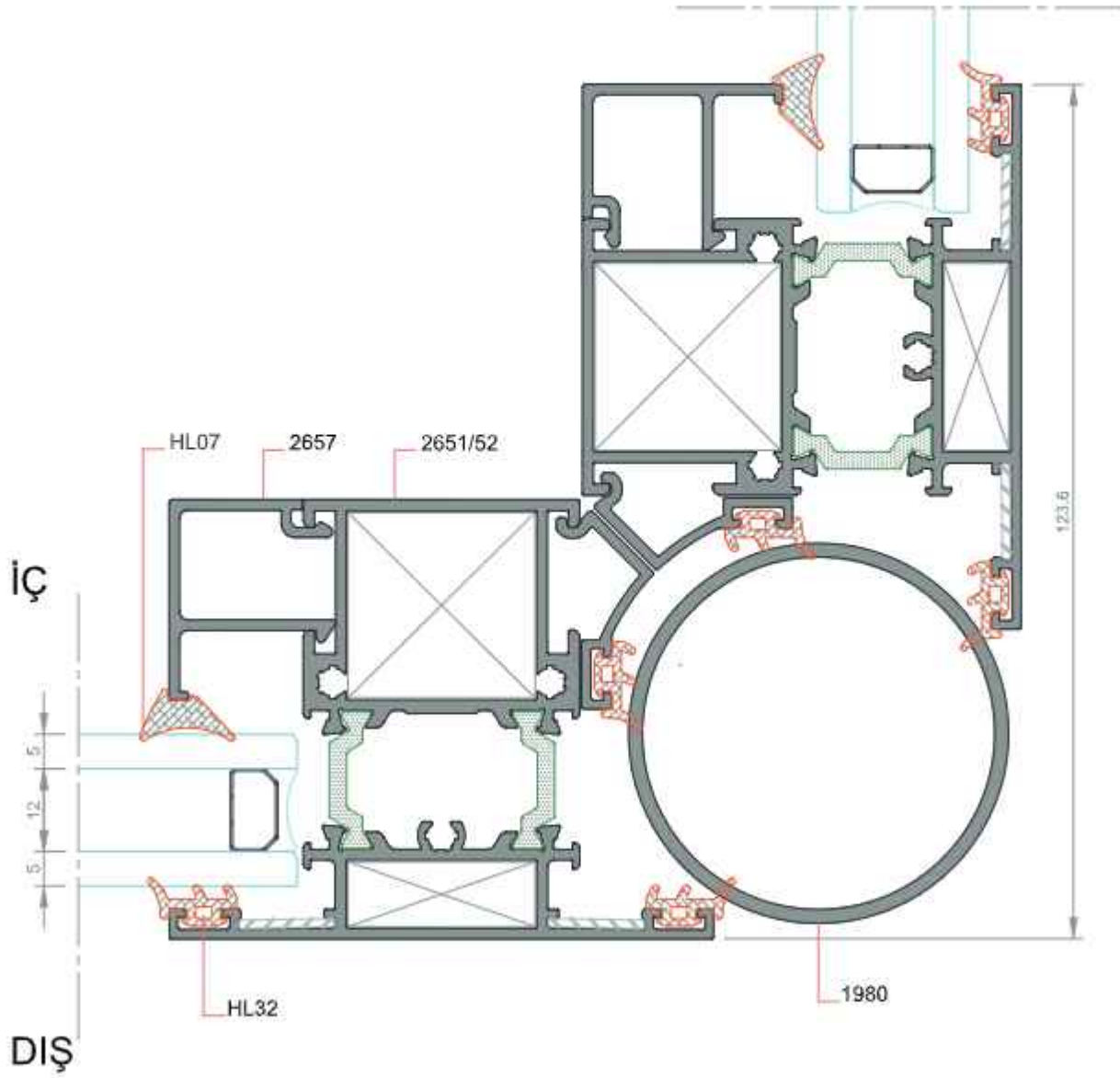

KAPI UYGULAMA TİPLERİ

★ Yandaki profil birim ağırlıkları, bilgisayarda hesaplanmış teorik ağırlıklardır.

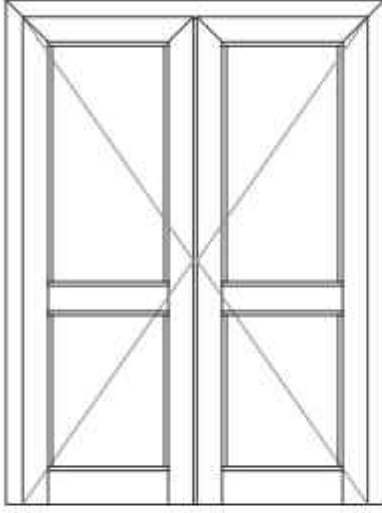

İçe Açılır Kapı

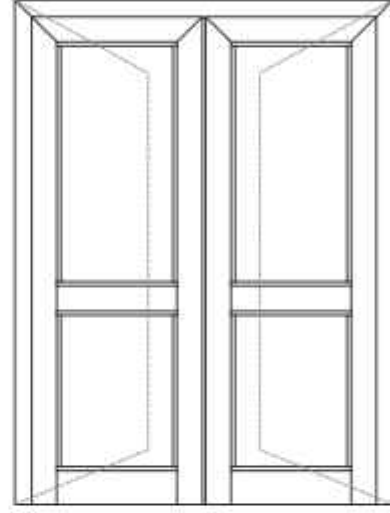

Dışa Açılır Kapı

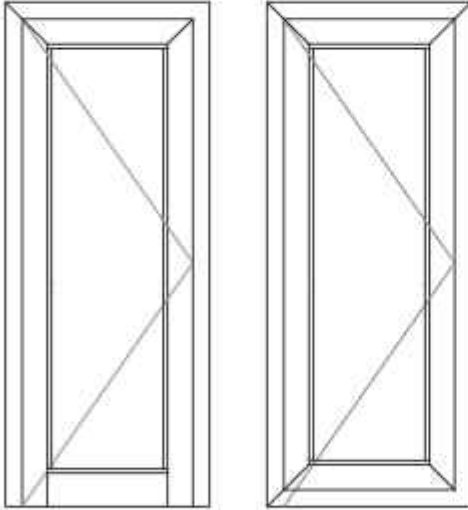

İçe Açılır Kapı

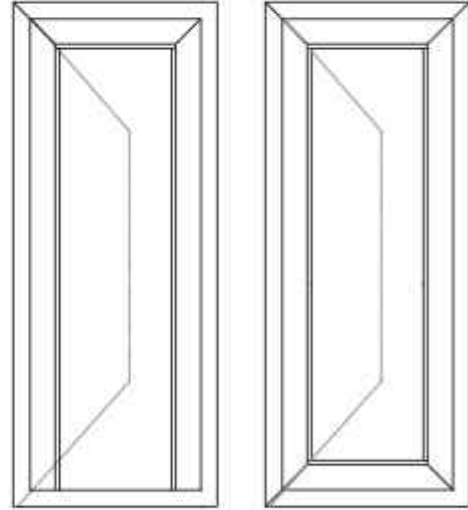

Dışa Açılır Kapı

DETAY- 1a
ÖLÇEK:1/1

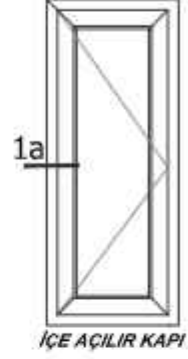

★ Yandaki profil birim ağırlıkları, bilgisayarda hesaplanmış teorik ağırlıklardır.

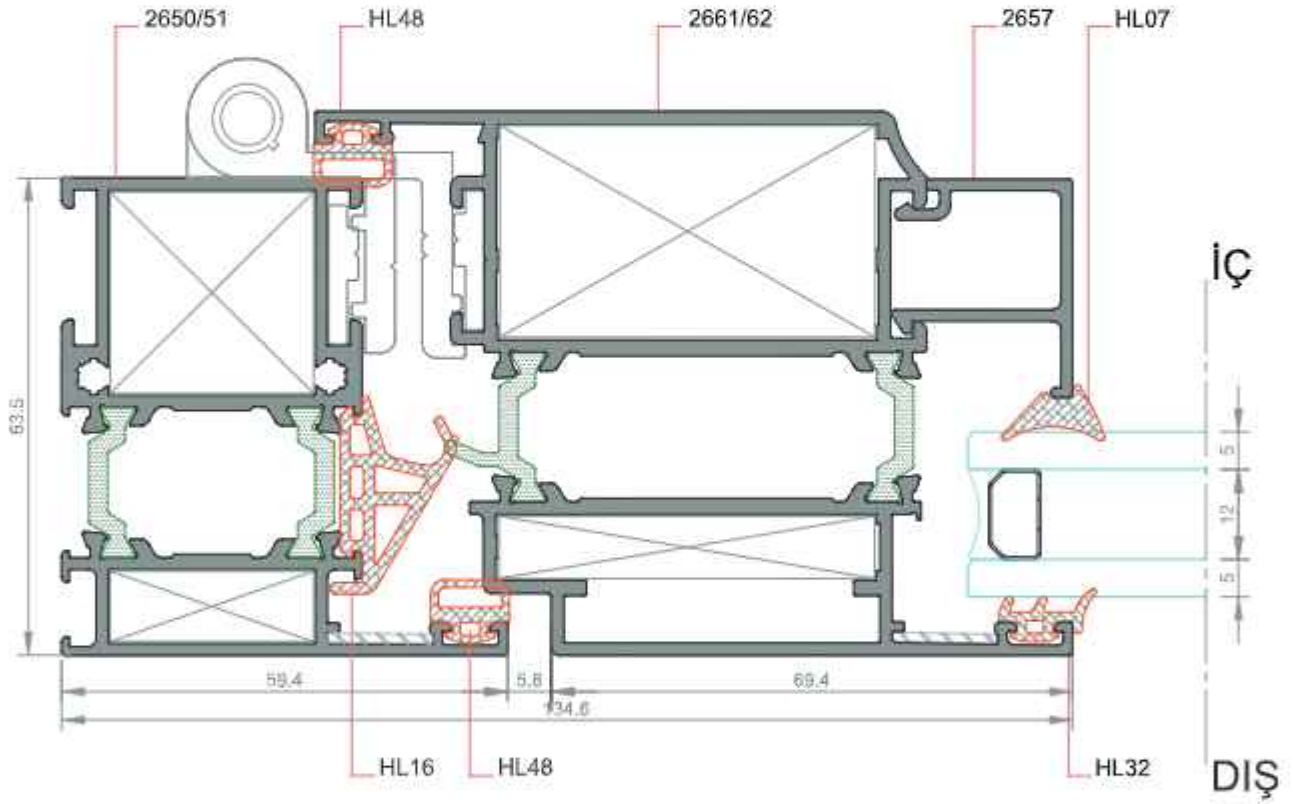

DETAY- 1b
ÖLÇEK:ÖLÇEKSİZ

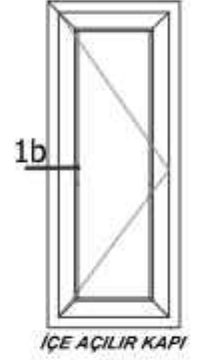

★ Yandaki profil birim ağırlıkları, bilgisayarda hesaplanmış teorik ağırlıklardır.

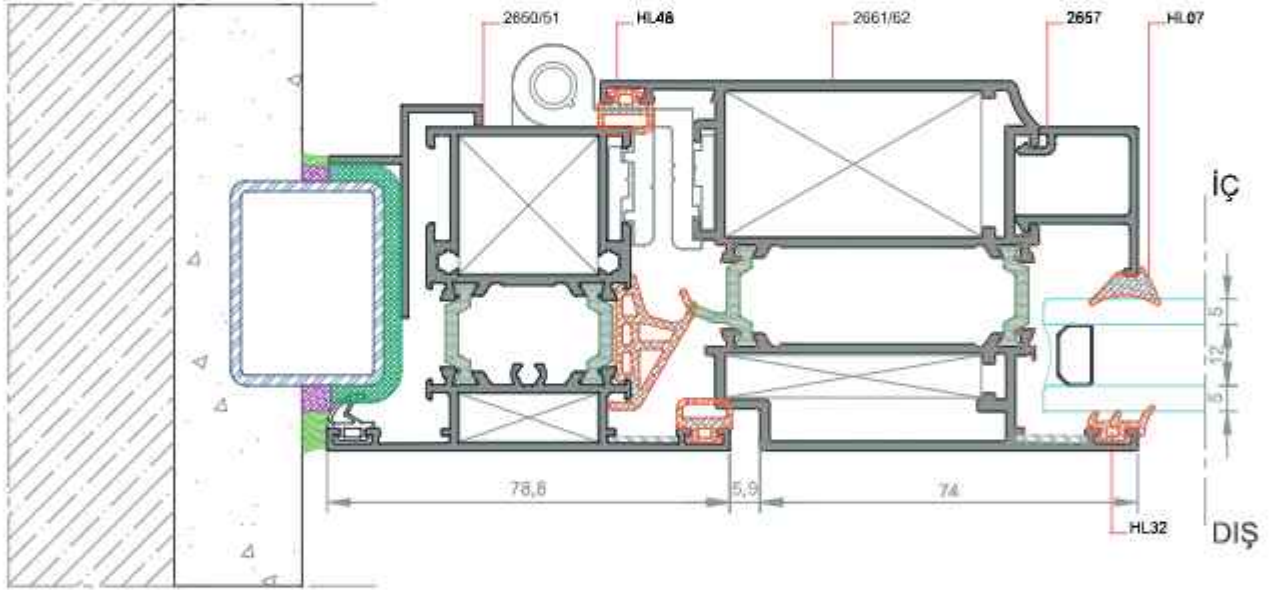

DETAY- 1c
ÖLÇEK:1/1

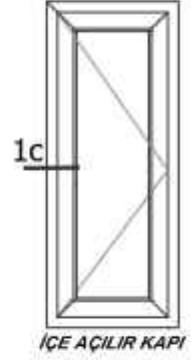

★ Yandaki profil birim ağırlıkları, bilgisayarda hesaplanmış teorik ağırlıklardır.

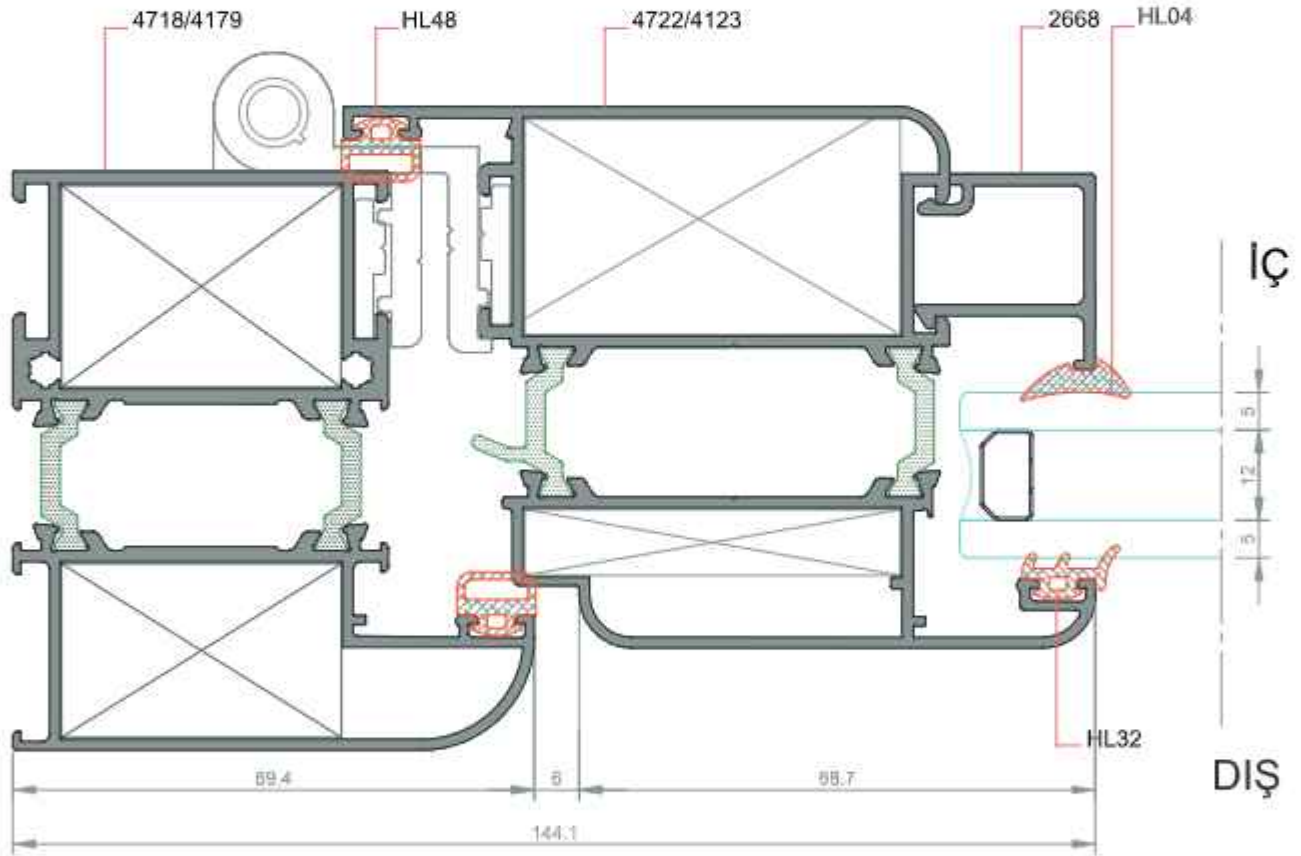

DETAY- 2a
ÖLÇEK:1/1

★ Yandaki profil birim ağırlıkları, bilgisayarda hesaplanmış teorik ağırlıklardır.

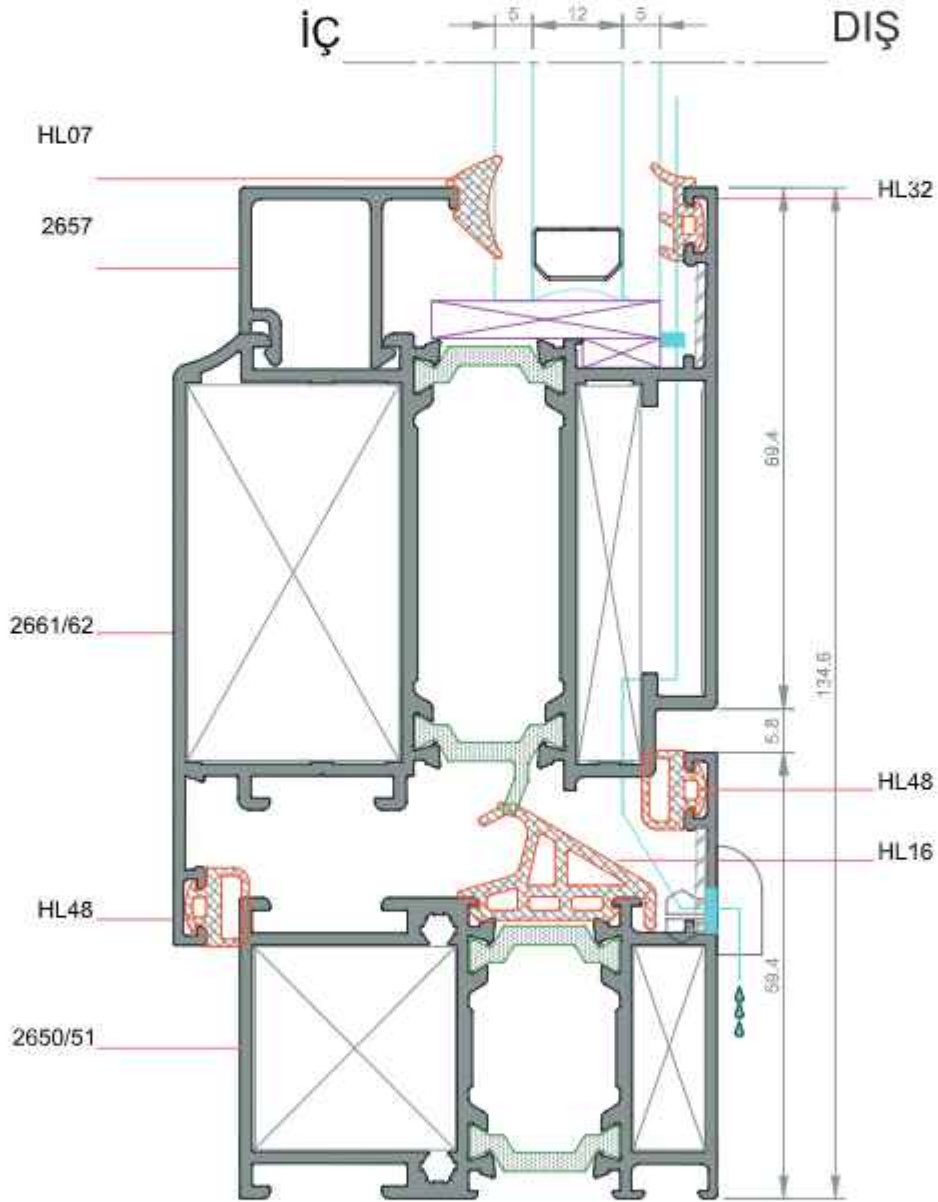

DETAY- 2b
ÖLÇEK:1/1

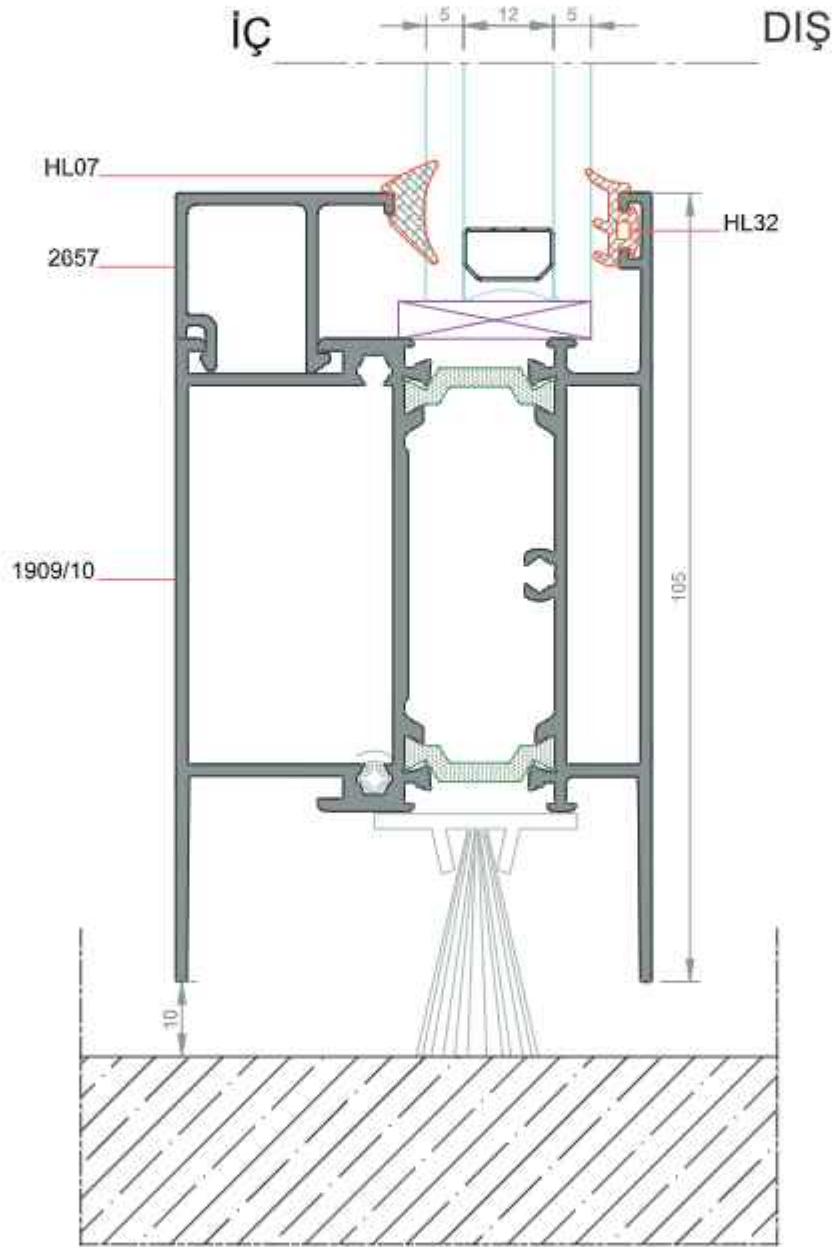
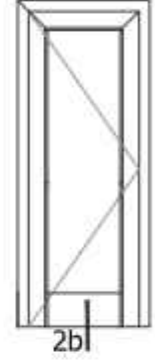

★ Yandaki profil birim ağırlıkları, bilgisayarla hesaplanmış teorik ağırlıklardır.

DETAY- 2c
ÖLÇEK:1/1

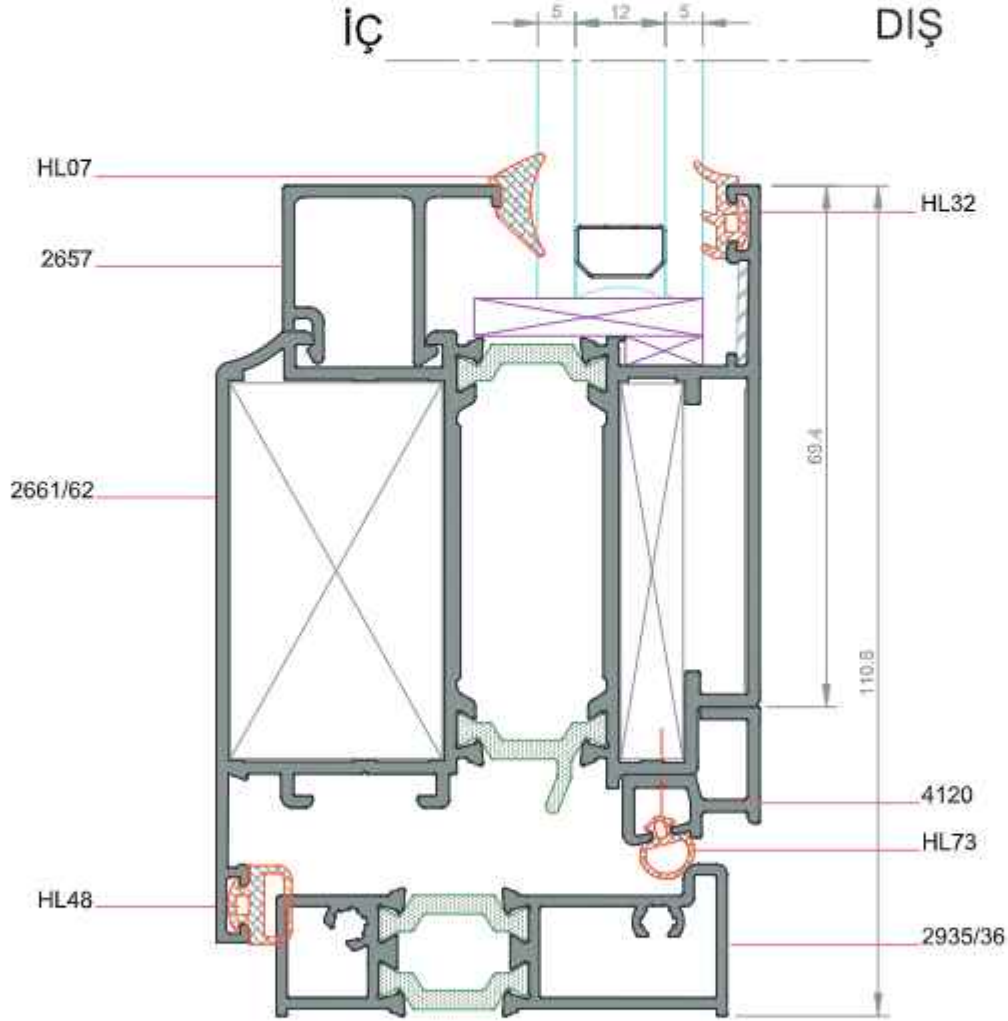
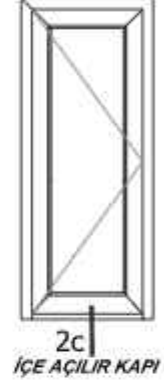

★ Yandaki profil birim ağırlıkları, bilgisayarda hesaplanmış teorik ağırlıklardır.

DETAY- 3
ÖLÇEK:1/1

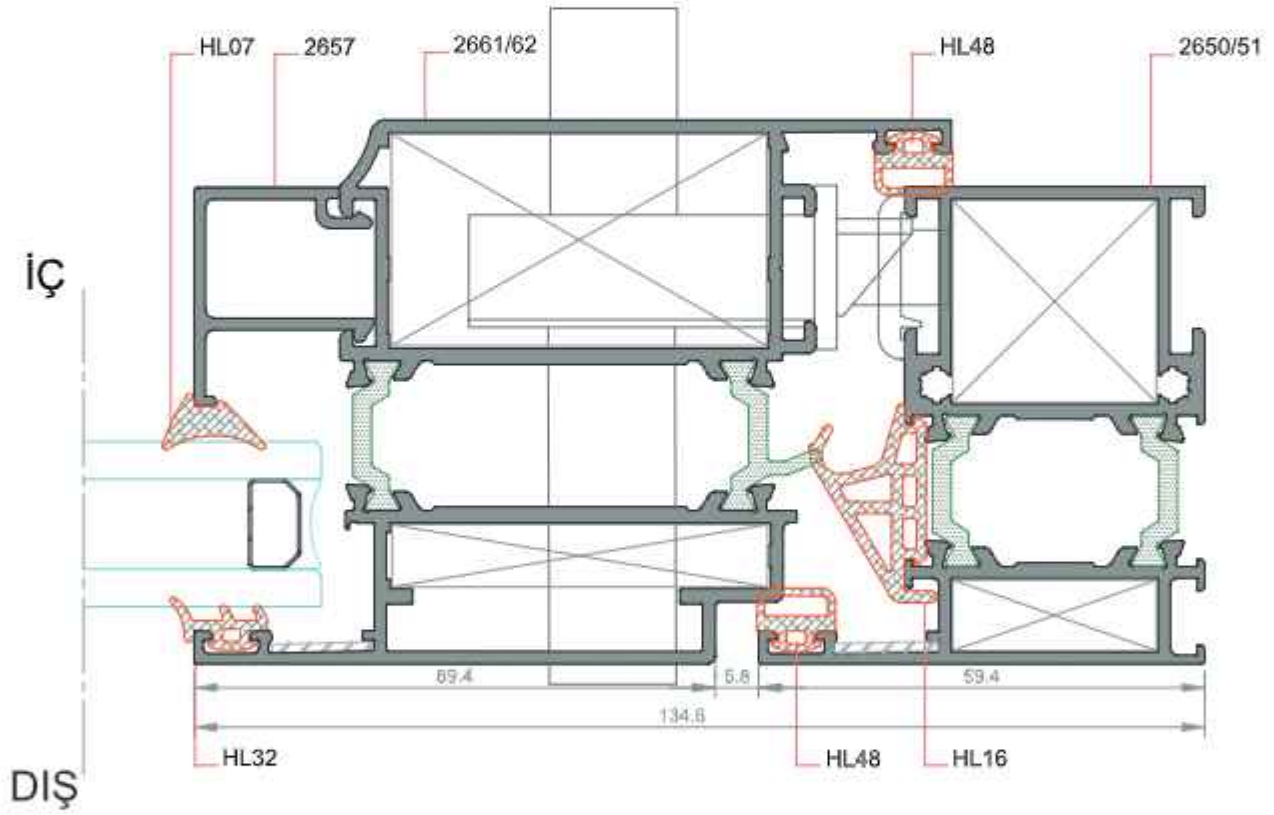
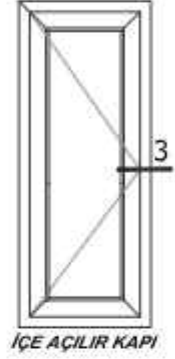

★ Yandaki profil birim ağırlıkları, bilgisayarda hesaplanmış teorik ağırlıklardır.

DETAY- 4
ÖLÇEK:1/1

★ Yandaki profil birim ağırlıkları, bilgisayarda hesaplanmış teorik ağırlıklardır.

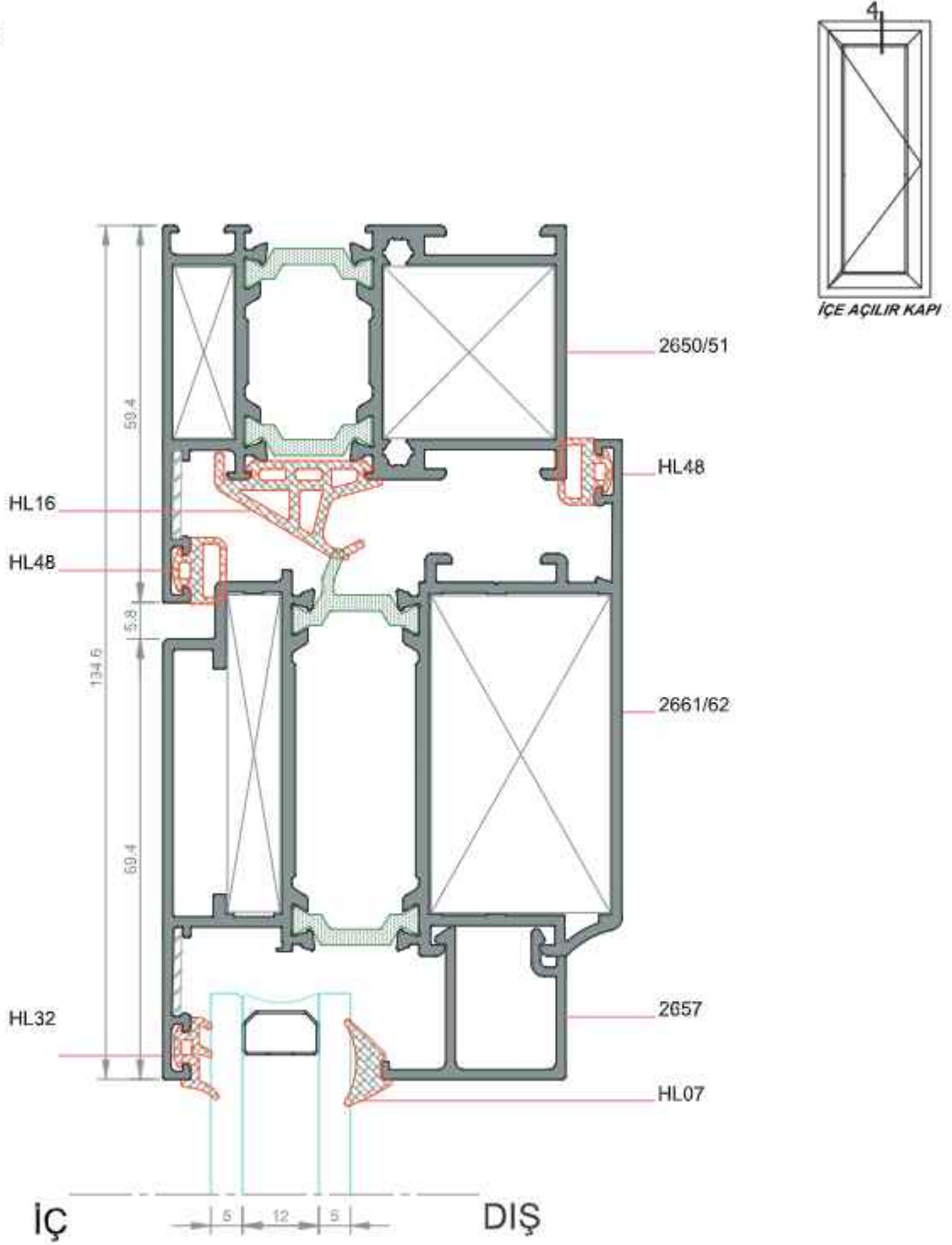

DETAY- 1

ÖLÇEK:1/1

★ Yandaki profil birim ağırlıkları, bilgisayarla hesaplanmış teorik ağırlıklardır.

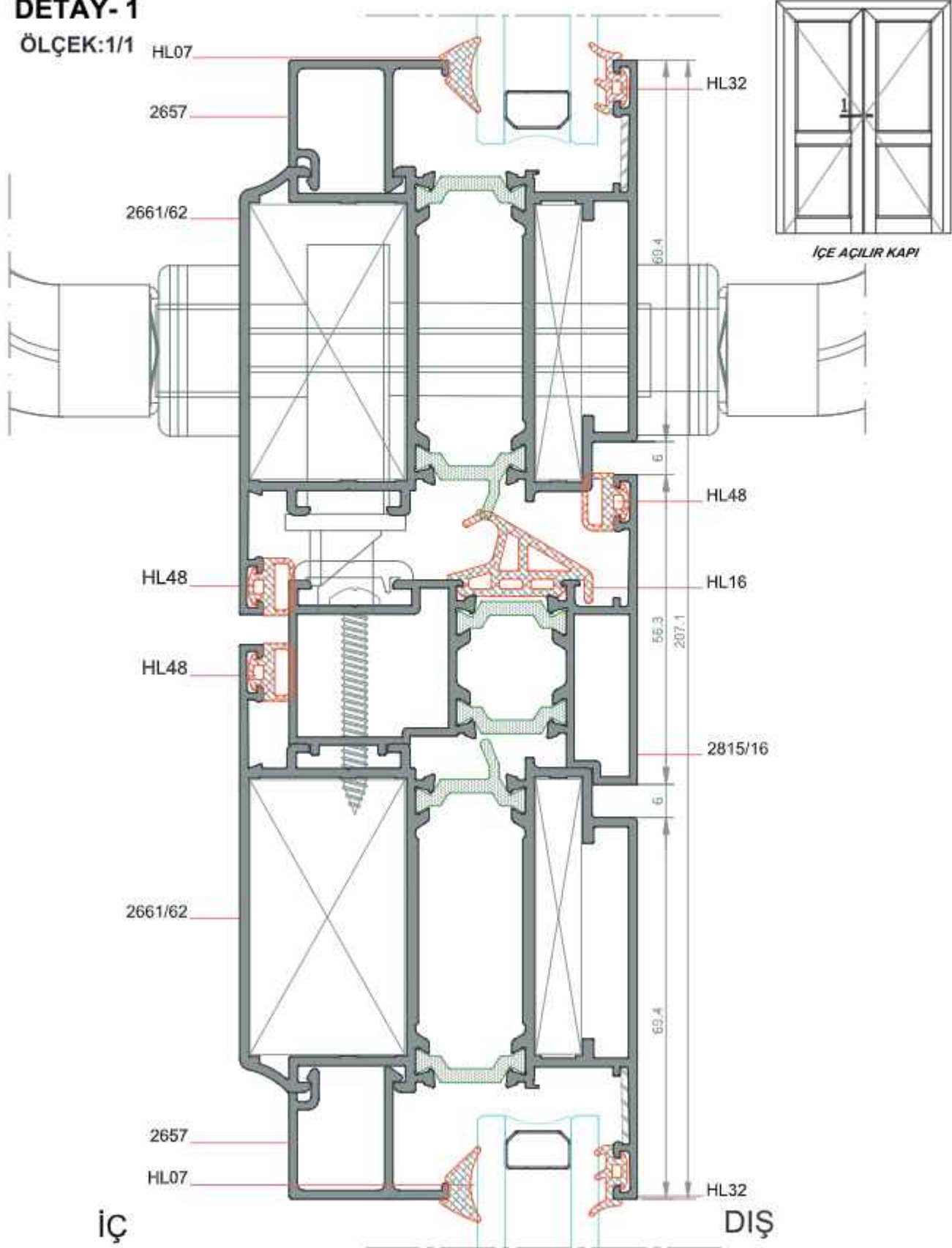

DETAY- 1
ÖLÇEK:1/1

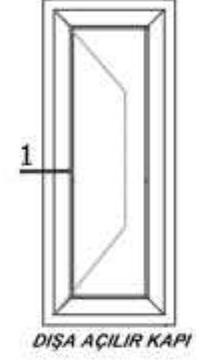

★ Yandaki profil birim ağırlıkları, bilgisayarda hesaplanmış teorik ağırlıklardır.

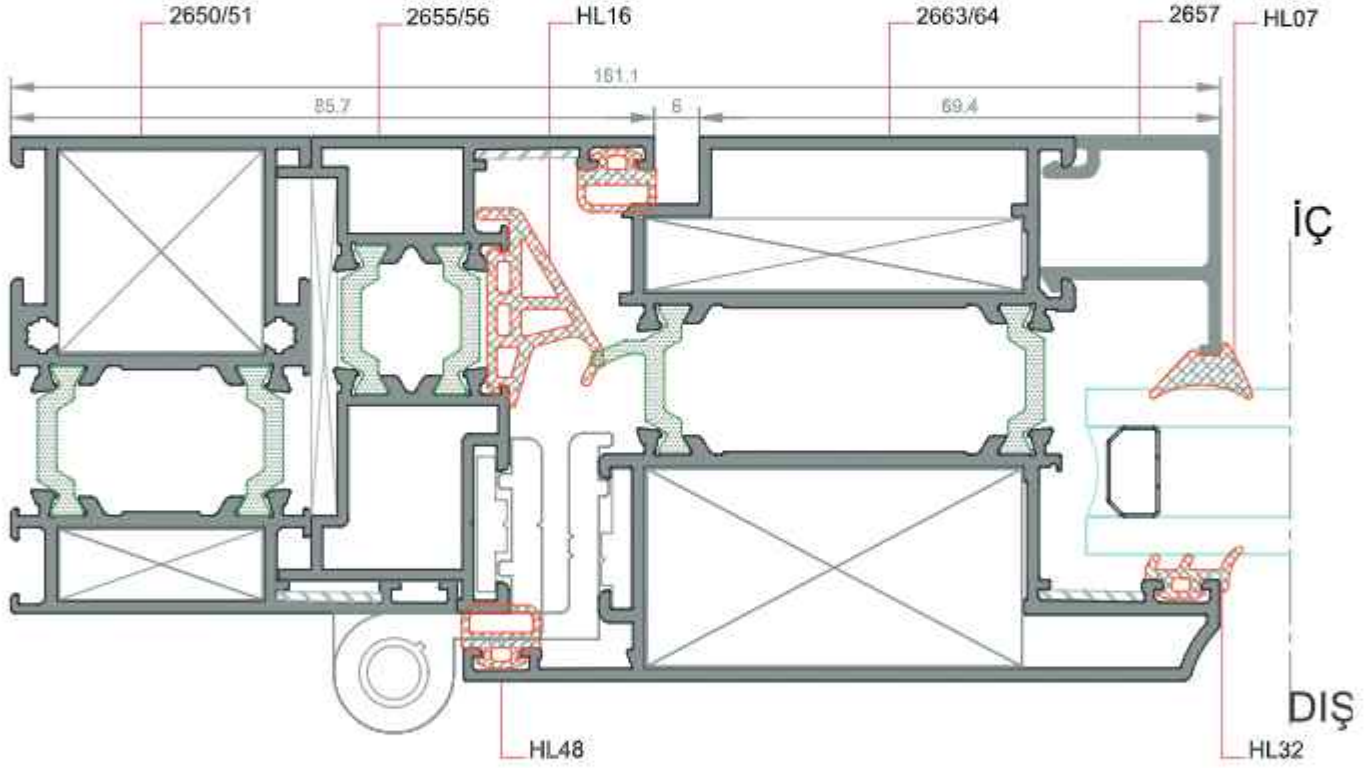

DETAY- 2a
ÖLÇEK:1/1

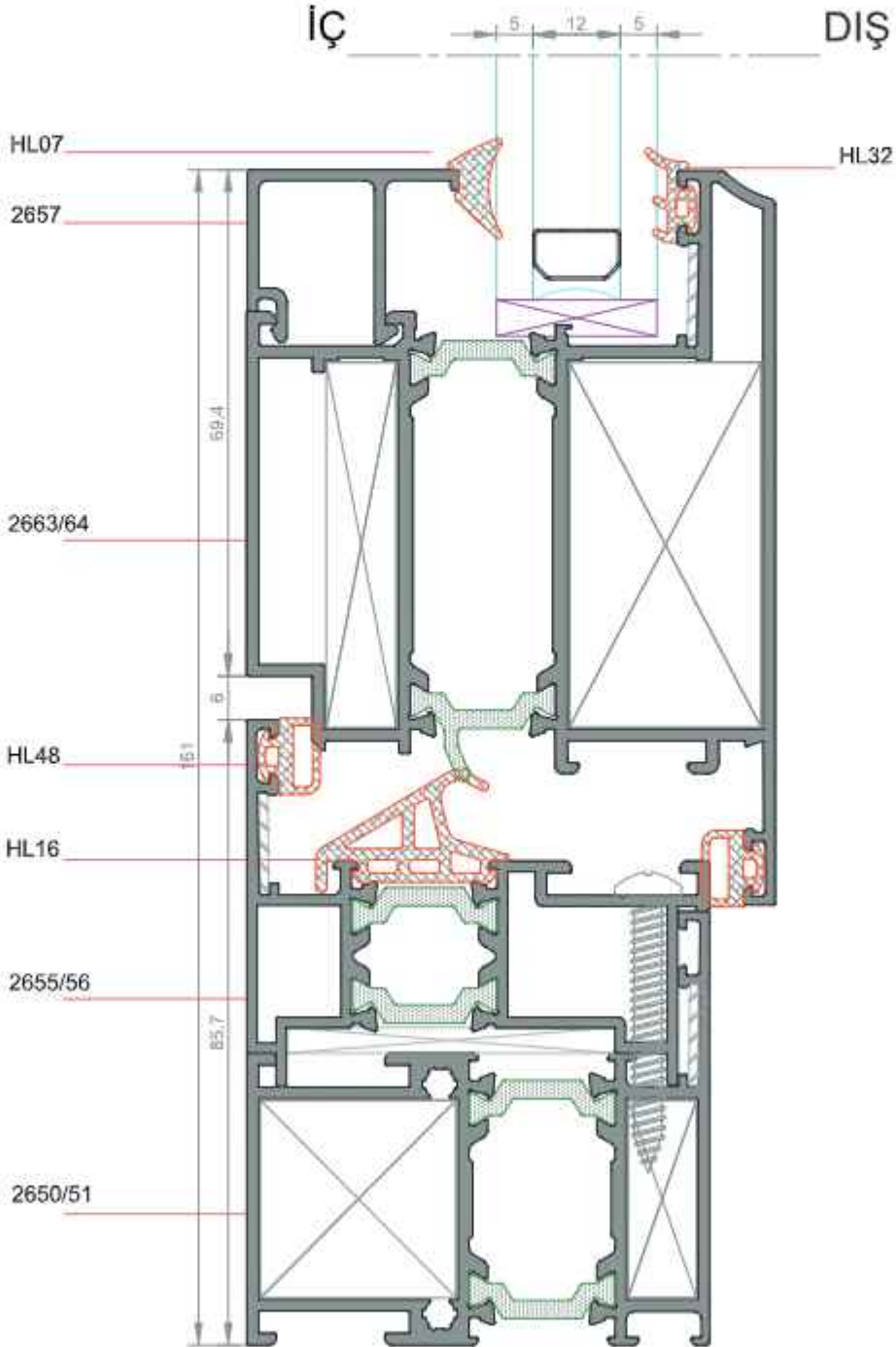
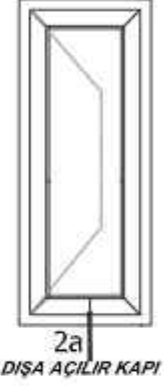

★ Yandaki profil birim ağırlıkları, bilgisayarla hesaplanmış teorik ağırlıklardır.

DETAY- 2b
ÖLÇEK:1/1

★ Yandaki profil birim ağırlıkları, bilgisayarda hesaplanmış teorik ağırlıklardır.

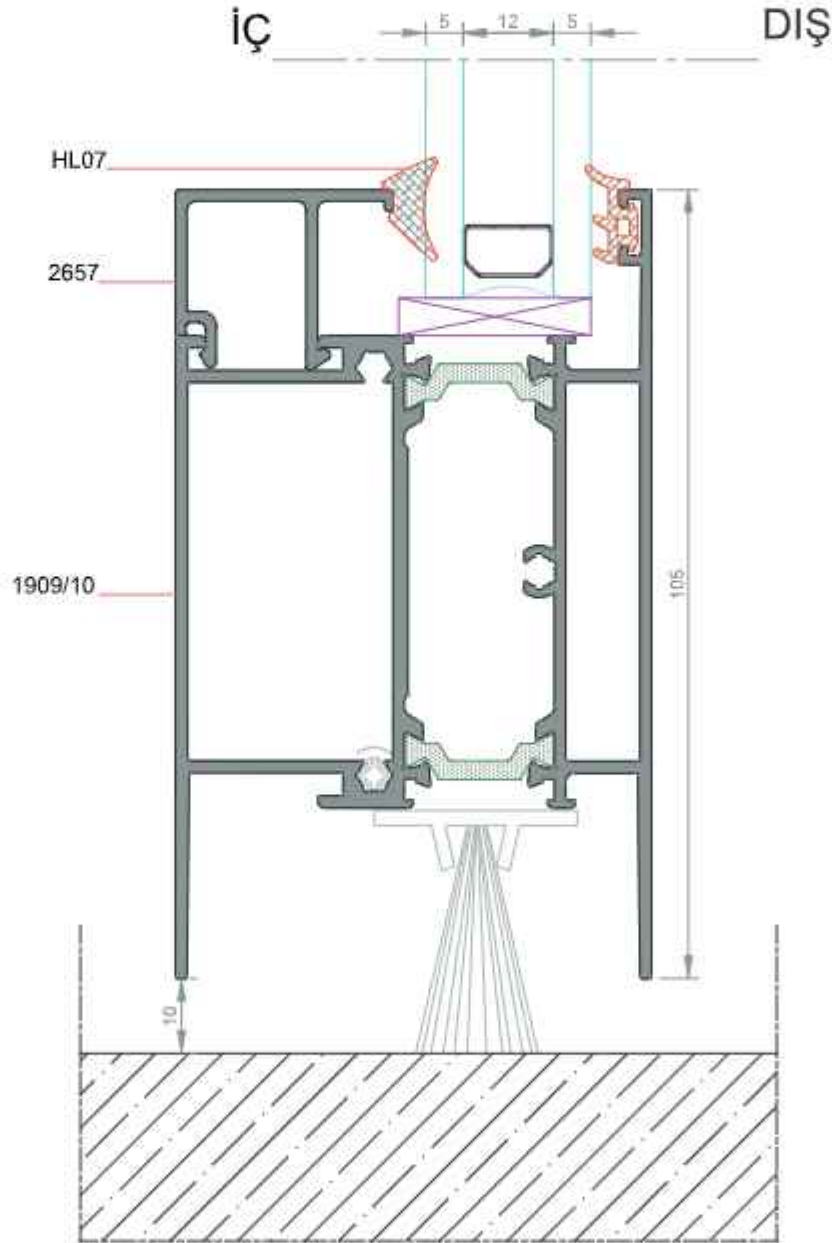

DETAY- 2c
ÖLÇEK:1/1

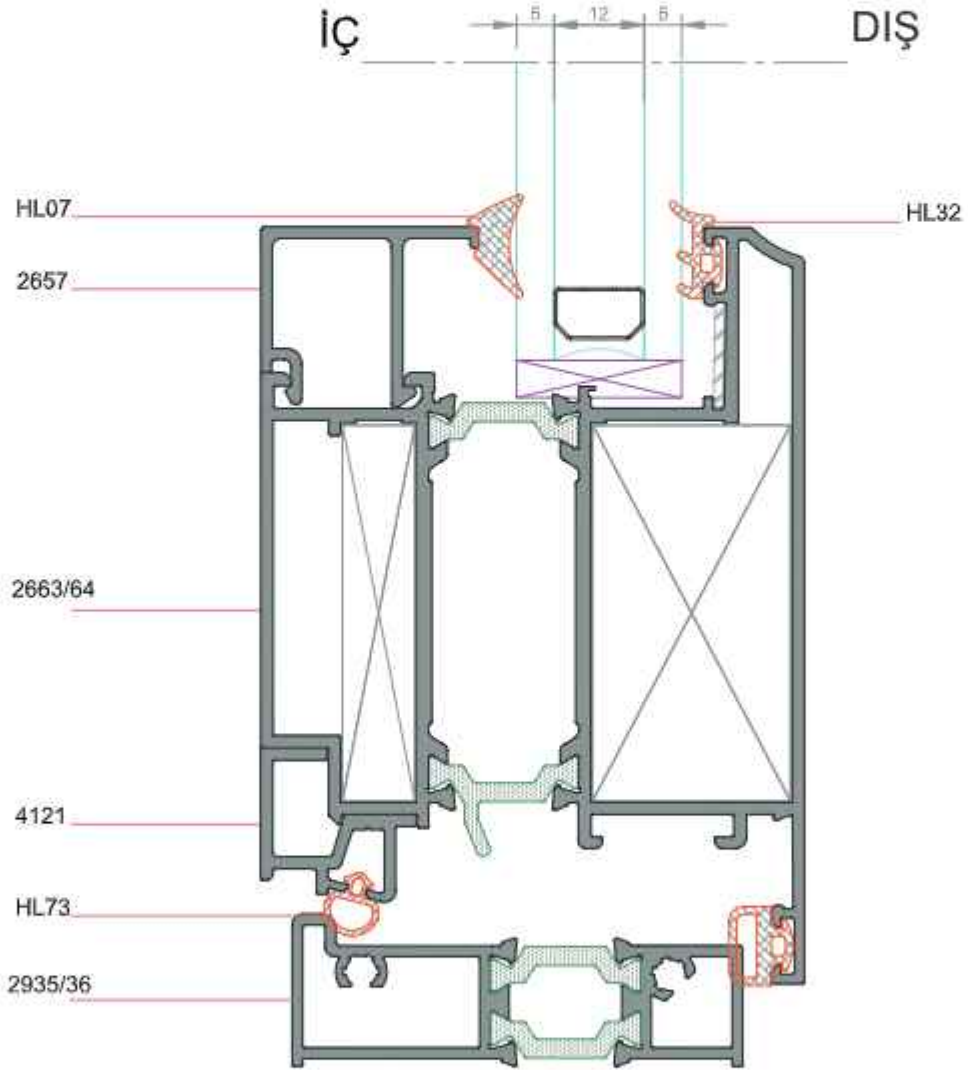

★ Yandaki profil birim ağırlıkları, bilgisayarla hesaplanmış teorik ağırlıklardır.

DETAY- 3
ÖLÇEK:1/1

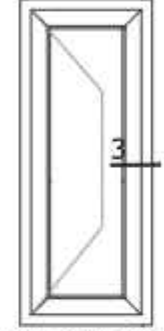

DIŞA AÇILIR KAPI

★ Yandaki profil birim ağırlıkları, bilgisayarda hesaplanmış teorik ağırlıklardır.

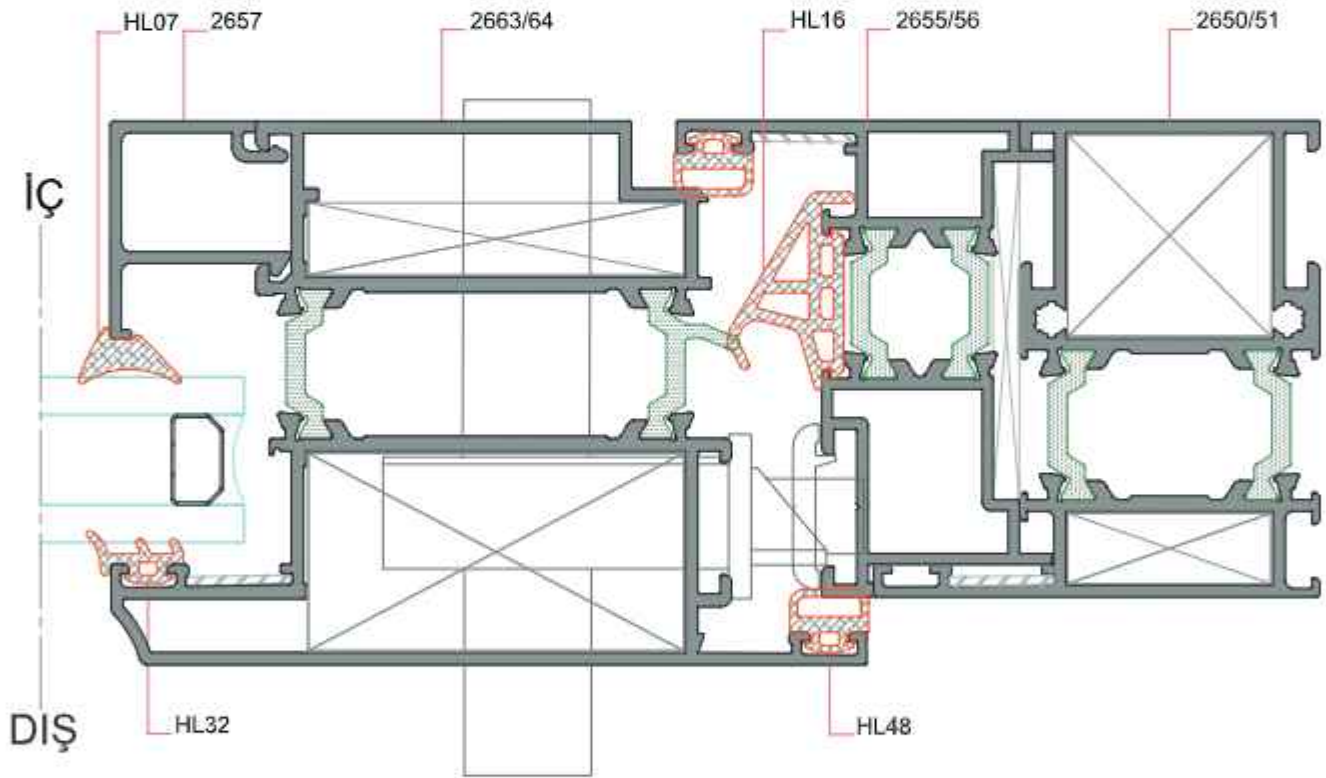

DETAY- 4
ÖLÇEK:1/1

★ Yandaki profil birim ağırlıkları, bilgisayarla hesaplanmış teorik ağırlıklardır.

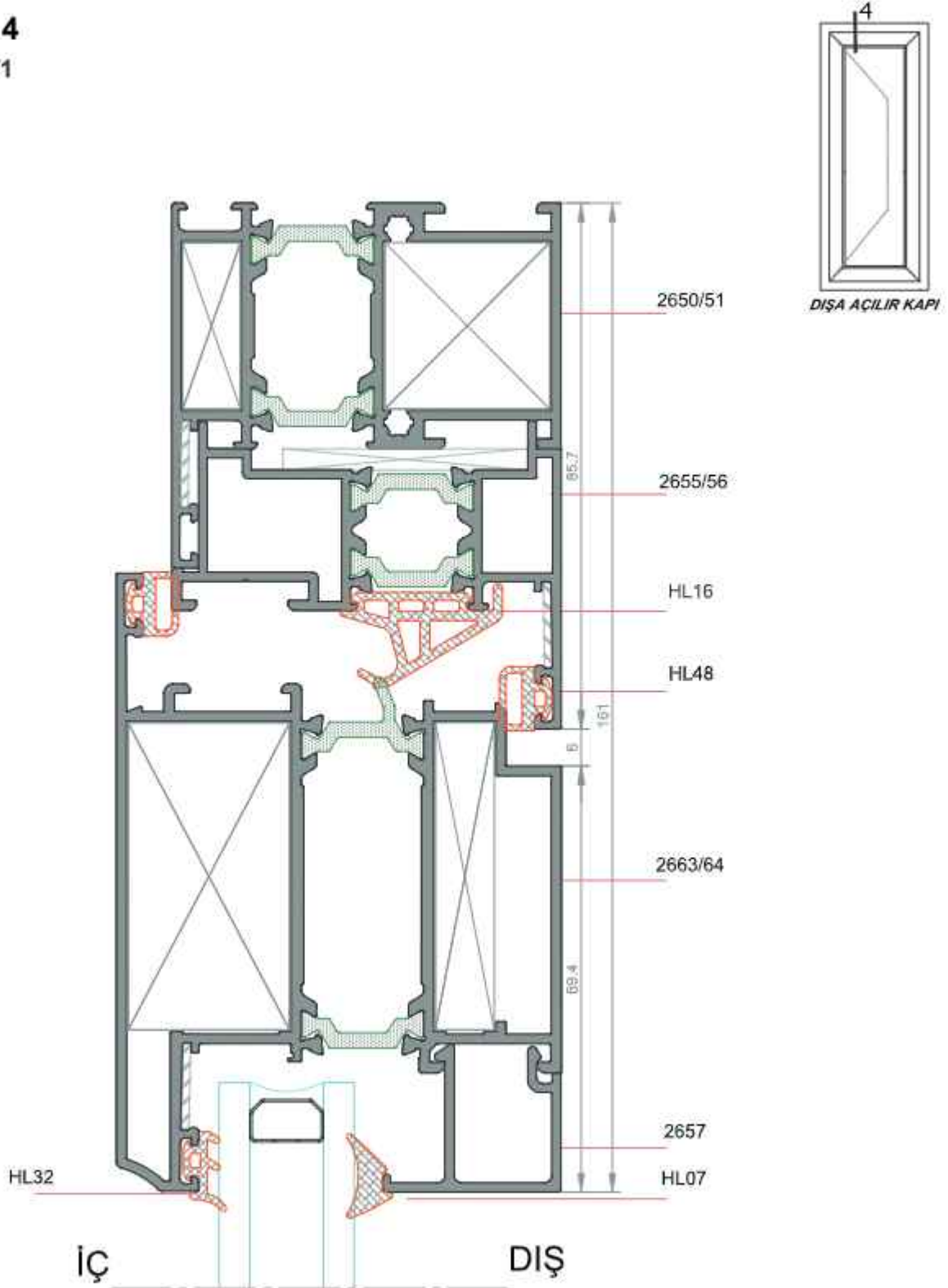

DETAY- 1

ÖLÇEK:1/1

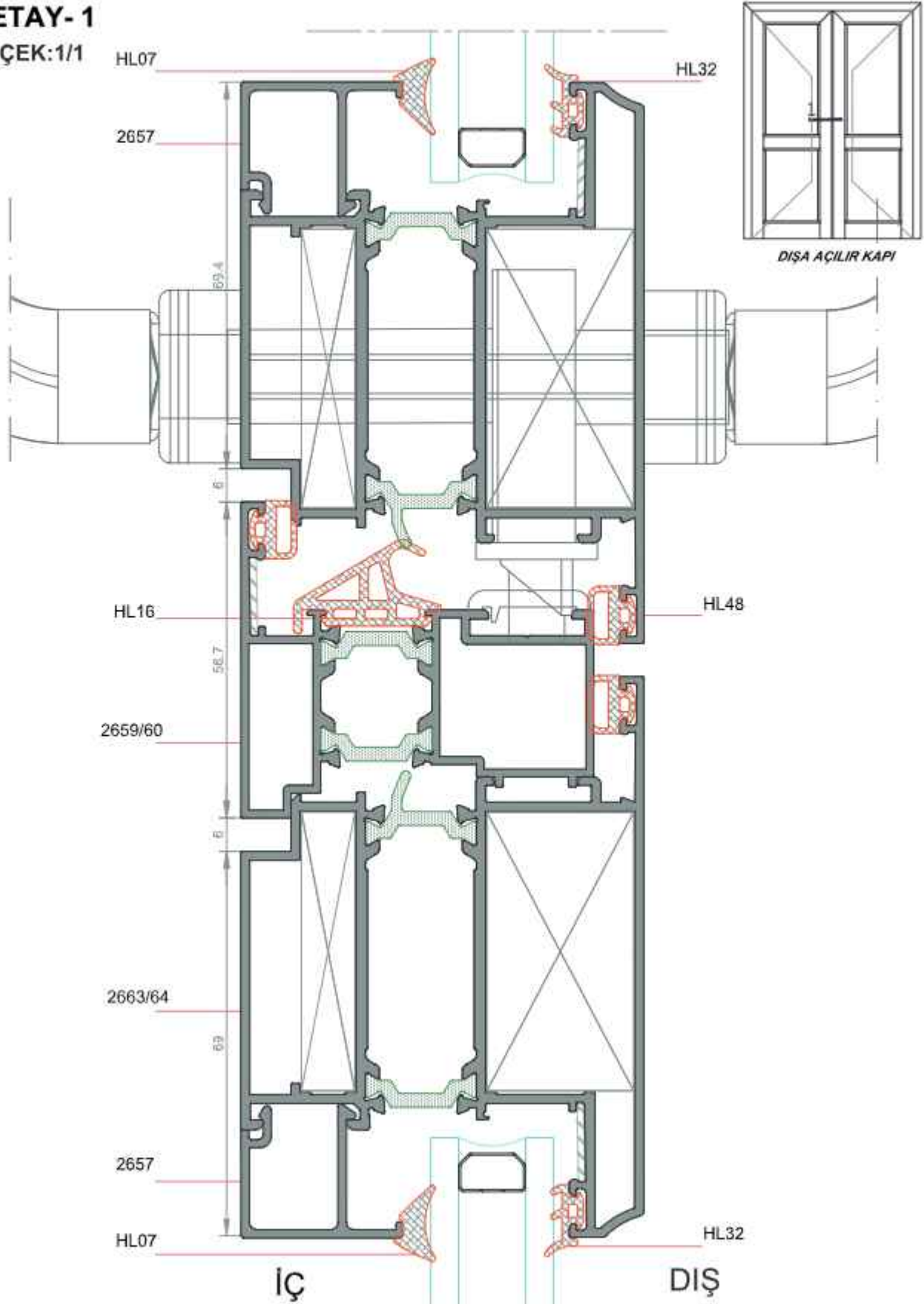

★ Yandaki profil birim ağırlıkları, bilgisayarla hesaplanmış teorik ağırlıklardır.

★ Yandaki profil birim ağırlıkları, bilgisayarda hesaplanmış teorik ağırlıklardır.

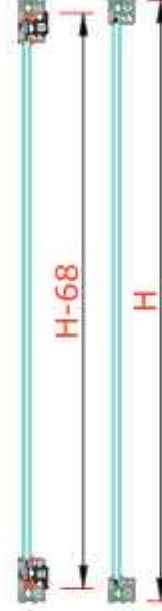
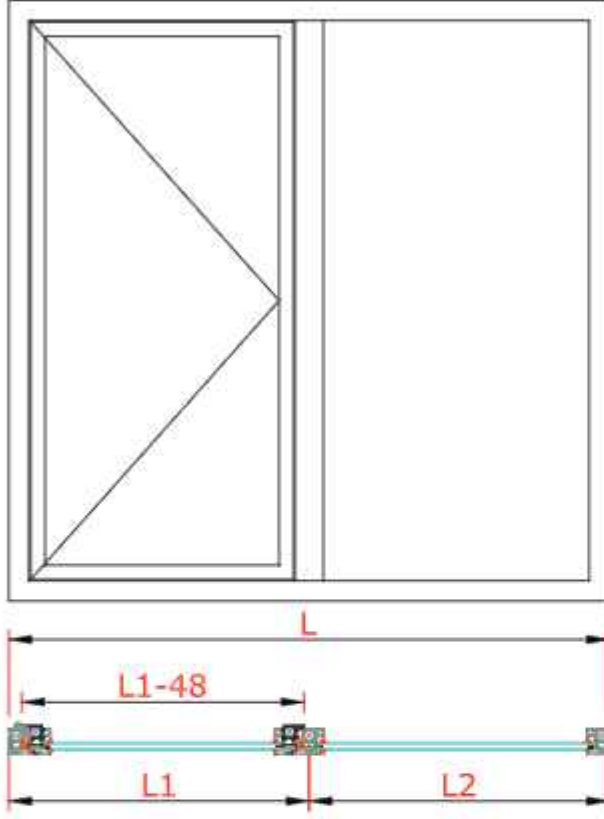

Profilin Adı	Profil Kodu	Profil Kesiti	Adet	Kesim Ölçüsü(mm)	Bağlantı Elemanları	Kod	Birim	Miktar	
Kasa Profili		2650/51	2	L	Köşe Takoğu (Kasa)	K3545 268	Adet	4	
			2	H	Köşe Takoğu (Kasa)	K3545 094	Adet	4	
Kanat Profili		2653/54	2	L1-48	Köşe Takoğu (Kanat)	K3545 283	Adet	4	
			2	H-68	Köşe Takoğu (Kanat)	K3545 083	Adet	4	
Orta Kayıt Profili		2651/52	1	H-70,7	Köşe Gönye (Kasa)	MP-KG 01	Adet	4	
					Köşe Gönye (Kanat)	MP-KG 01	Adet	4	
Cam Çıtası Profili	Kanat		2		Cam (Açılır)		Adet	Cam Detayı	Kesim Ölçüsü (mm)
			2		Dış Cam	1			
Cam Çıtası Profili	Kasa Orta Kayıt		2		İç Cam				
			2		Cam (Sabit)	Adet	Cam Detayı	Kesim Ölçüsü (mm)	
Cam Çıtası Profili	Kasa Orta Kayıt		2		Dış Cam	1			
			2		İç Cam				

★ Yandaki profil birim ağırlıkları, bilgisayarda hesaplanmış teorik ağırlıklardır.

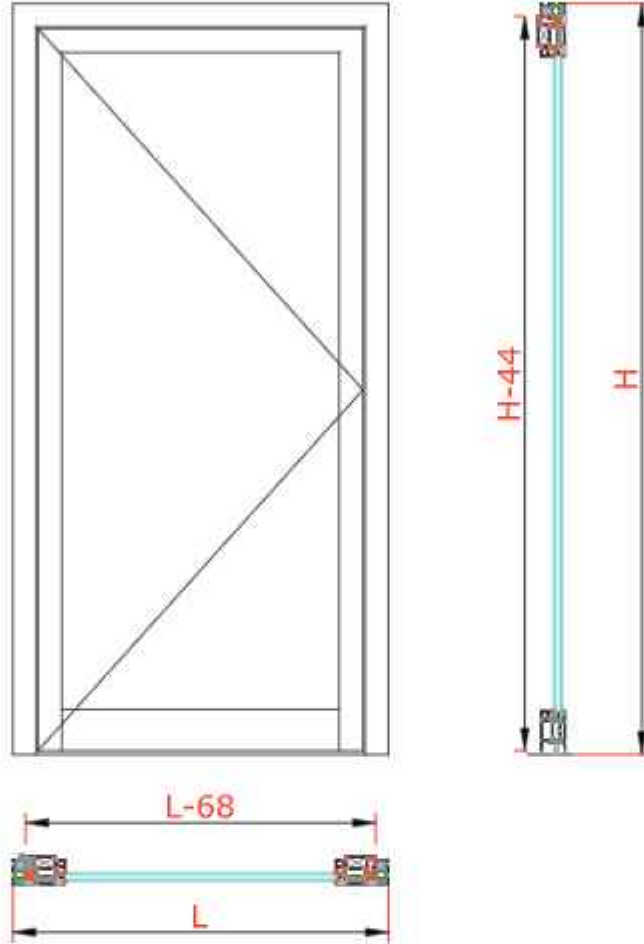

Profilin Adı	Profil Kodu	Profil Kesiti	Adet	Kesim Ölçüsü(mm)
Kasa Profili			1	L
			2	H
Kanat Profili			1	L-68
			2	H-44
Etek Profili			1	L-230,4
Cam Çıtası Profili			2	
			2	

Bağlantı Elemanları	Kod	Birim	Miktar
Köşe Takozu (Kasa)	K3545 268	Adet	2
Köşe Takozu (Kasa)	K3545 094	Adet	2
Köşe Takozu (Kanat)	K3546 283	Adet	2
Köşe Takozu (Kanat)	K3546 083	Adet	2
Köşe Gönye (Kasa)	MP-KG 01	Adet	2
Köşe Gönye (Kanat)	MP-KG 01	Adet	2

CAM (Açılır)	Adet	Cam Detayı	Kesim Ölçüsü (mm)
Dış Cam	1		
İç Cam			



PROFİL KATALOĐU











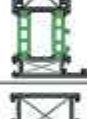

GXY H77 ISI YALITIMLI KAPI VE PENCERE SİSTEMLERİ

*GXY H77 THERMAL INSULATED DOOR &
WINDOW SYSTEMS*







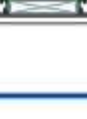





* Profil Ađırlıkları Teorik Olup Teslim Anındaki Ađırlık Geerlidir

* *Weight of profiles are theoretical, net weight will valid at the time of delivery.*



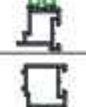

★ Yandaki profil birim ağırlıkları, bilgisayarda hesaplanmış teorik ağırlıklardır.

PROFİL KESİTİ	PROFİL KODU	PROFİL ADI	AĞIRLIK	ATALET MOMENTLERİ		SAYFA NO
				J_x (cm ⁴)	J_y (cm ⁴)	
	2909/10 (1.6mm)	Dar Kasa Profili	1,494 kg/m	37,46	7,51	
	2909/13 (1.6mm)	Dar Orta Kayıt Profili	1,599 kg/m	38,89	9,20	
	2911/12 (1.6mm)	Dar Kanat Profili	1,583 kg/m	55,45	8,21	
	2650/51 (1.4 mm)	Geniş Kasa Profili	1,562 kg/m	40,10	14,14	
	2650/51 (1.6 mm)	Geniş Kasa Profili	1,681 kg/m	43,58	15,20	
	2650/51 (1.8 mm)	Geniş Kasa Profili	1,770 kg/m	46,74	15,82	
	4452/53 (1.4 mm)	Geniş Kasa Profili	1,877 kg/m	46,80	26,47	
	4452/53 (1.6 mm)	Geniş Kasa Profili	1,960 kg/m	53,24	27,18	
	4718/19 (1.4 mm)	Geniş Oval Kasa Profili	2,020 kg/m	67,02	30,50	
	4894/95 (1.4 mm)	Pervazlı Kasa Profili	1,744 kg/m	57,83	20,05	
	2651/52 (1.4 mm)	Geniş Orta Kayıt Profili	1,667 kg/m	41,12	15,07	
	2651/52 (1.6 mm)	Geniş Orta Kayıt Profili	1,803 kg/m	44,80	15,98	
	2651/52 (1.8 mm)	Geniş Orta Kayıt Profili	1,875kg/m	47,85	16,52	
	2933/34 (1.5mm)	Baza Orta Kayıt Profili	2,213 kg/m	57,69	42,64	



★ Yandaki profil birim ağırlıkları, bilgisayarda hesaplanmış teorik ağırlıklardır.

PROFIL KESİTİ	PROFIL KODU	PROFIL ADI	AĞIRLIK	ATALET MOMENTLERİ		SAYFA NO
				J_x (cm ⁴)	J_y (cm ⁴)	
	2651/4513 (1.6mm)	Takviyeli Orta Kayıt Profili	2,355 kg/m	110,65	25,68	
	2653/54 (1.4 mm)	Geniş Kanat Profili	1,677 kg/m	58,52	16,28	
	2653/54 (1.6 mm)	Geniş Kanat Profili	1,780 kg/m	62,06	16,99	
	2653/54 (1.8 mm)	Geniş Kanat Profili	1,884 kg/m	53,29	17,65	
	4720/21 (1.4 mm)	Oval GenişKanat Profili	1,686 kg/m	59,10	16,67	
	2661/62 (1.6 mm)	Kapı Kanat Profili	2,317 kg/m	86,27	48,41	
	2661/62 (1.8 mm)	Kapı Kanat Profili	2,381 kg/m	89,10	49,53	
	4722/23 (1.5 mm)	Oval Kapı Kanat Profili	2,003 kg/m	79,74	41,87	
	2663/64 (1.6 mm)	Kapı Kanat Profili (Dışa Açılır)	2,332 kg/m	77,26	61,31	
	2663/64 (1.8 mm)	Kapı Kanat Profili (Dışa Açılır)	2,439 kg/m	82,74	63,29	
	2659/60 (1.4mm)	Dışa Açılır Çift Kapı Adaptörü	1,403 kg/m	35,69	8,84	
	2655/56 (1.4mm)	Dışa Açılır Kapı Adaptörü	1,303 kg/m	31,96	5,25	
	2815/16 (1.5mm)	Çift Kapı Adaptörü	1,404 kg/m	35,88	8,96	
	4899/4900 (1.5mm)	Pivot Kanat Adaptörü	1,502 kg/m	42,86	10,37	

★ Yandaki profil birim ağırlıkları, bilgisayarda hesaplanmış teorik ağırlıklardır.

PROFİL KESİTİ	PROFİL KODU	PROFİL ADI	AĞIRLIK	ATALET MOMENTLERİ		SAYFA NO
				J_x (cm ⁴)	J_y (cm ⁴)	
	1909/10 (1.5mm)	Etek Profili	2,298 kg/m	70,14	57,58	
	2935/36 (1.4mm)	Eşik Profili	0,948 kg/m	20,96	1,38	
	3141/42 (1.4mm)	Ek Profili	1,344 kg/m	62,69	3,30	
	4120	Eşik-Kanat Adaptör Profili-İç	0,245 kg/m	
	4121	Eşik-Kanat Adaptör Profili-Dış	0,279 kg/m	
	2260	Pervaz Profili	0,625 kg/m	
	2259	Pervaz Profili	0,486 kg/m	
	1210	İspanyolet Çubuğu	0,112 kg/m	
	2660	Köşe Dönüş Adaptörü Dış	0,181 kg/m	
	2667	Köşe Dönüş Adaptörü İç	0,179 kg/m	
	4124	Cam Çıtası	0,308 kg/m	
	2668	Cam Çıtası	0,330 kg/m	
	2657	Cam Çıtası	0,332 kg/m	
	2914	Cam Çıtası	0,349 kg/m	

★ Yandaki profil birim ağırlıkları, bilgisayarda hesaplanmış teorik ağırlıklardır.

PROFİL KESİTİ	PROFİL KODU	PROFİL ADI	AĞIRLIK	ATALET MOMENTLERİ		SAYFA NO
				J_x (cm ⁴)	J_y (cm ⁴)	
	3136	Cam Çıtası	0,364 kg/m	
	3183	Cam Çıtası	0,377 kg/m	
	4122	Cam Çıtası	0,390 kg/m	
	4123	Cam Çıtası	0,402 kg/m	
	2181	Damlalık Profili	0,168 kg/m	
	1980	55'lik Boru Profili	0,902 kg/m	
	2000	70'lik Boru Profili	0,875 kg/m	
	4125	Çektirme Takozu	1,099 kg/m	
	4133	Çektirme Takozu	0,566 kg/m	
	3546	Köşe Takozu	6,304 kg/m	
	3545	Köşe Takozu	4,616 kg/m	
	2917	Köşe Takozu	3,469 kg/m	
	2929	Köşe Takozu	3,341 kg/m	

★ Yandaki profil birim ağırlıkları, bilgisayarda hesaplanmış teorik ağırlıklardır.

AKSESUAR KESİTİ	AKSESUAR KODU	AKSESUAR ADI	AĞIRLIK	PAKETLEME	SAYFA NO
	HL49	Orta Bini Fiteli	291,5 gr/m	15 kg/ 48m	
	HL48	Kanat Fiteli	73 gr/m	15 kg/ 205m	
	HL32	Dış Cam Fiteli	46 gr/m	15 kg/ 326m	
	HL31(2mm)	Kama Fiteli	40 gr/m	15 kg/ 375m	
	HL07(4mm)	Kama Fiteli	63 gr/m	15 kg/ 238m	
	HL04(3mm)	Kama Fiteli	60 gr/m	15 kg/ 250m	
	HL73	Eşik Fiteli	30 gr/m	15 kg/ 500m	
	MP-56-04/3-1	Köşe Gönye	...	250 Ad/ Paket	
	MP-HG	Çift Kapı Adaptör Kapağı 1Takım (Sağ-Sol)	...	25Sağ 25Sol/ 1 Paket	
	MP-6-36138 -20-LR-0-1	Mentеше	...	100 Ad/ 1 Paket	
	MP26-03/2	Mentеше	...	150 Ad/ 1 Paket	
	MP56-07/5H	Seri Sistem Mentеше	...	200 Ad/ 1 Paket	
	00535	Kapı Mentеше	...	200 Ad/ 1 Paket	

★ Yandaki profil birim ağırlıkları, bilgisayarda hesaplanmış teorik ağırlıklardır.

AKSESUAR KESİTİ	AKSESUAR KODU	AKSESUAR ADI	AĞIRLIK	PAKETLEME	SAYFA NO
	MP31-02/09-1	Paslanmaz Tek Büküm Oval Yale Kol	...	30 Ad/ 1 Paket	
	MP31-11	Boru Kol	...	10 Ad/ 1 Paket	
	MP29-04	Alüminyum Pencere Kolu	...	100 Ad/ 1 Paket	
	MP32-01/1	Boyunlu Eksenel Kol Tek Dilli	...	50 Ad/ 1 Paket	
	MP31-01	Yaylı Sosis Kol	...	50 Ad/ 1 Paket	
	MP31-09/13	Yaylı Dar Aynalı Sosis Kol	...	30 Ad/ 1 Paket	
	MP31-07/2Y	Yaylı Düz Rozetli Sosis Kol	...	50 Ad/ 1 Paket	
	MP31-24/2H	Akbank Havuzlu Kol Aparatı	...	30 Ad/ 1 Paket	
	MP31-24/20	Akbank 40'lık Kol Aparatı	...	30 Ad/ 1 Paket	
	MP34-254/96	96 mm Barel	...	30 Ad/ 1 Paket	
	MP34-04/5	Dilli Kilit (153-35)	...	30 Ad/ 1 Paket	
	MP34-02/7	Makaralı Kilit (155-35)	...	30 Ad/ 1 Paket	

★ Yandaki profil birim ağırlıktan, bilgisayarda hesaplanmış teorik ağırlıklardır.

AKSESUAR KESİTİ	AKSESUAR KODU	AKSESUAR ADI	AĞIRLIK	PAKETLEME	SAYFA NO
	MP33-12	Isı yalıtımlı Uzun Sürgü	...	100 Ad/ 1 Paket	
	MP56-01/6/3-1	Dilli Kilit Karşılığı	...	50 Ad/ 1 Paket	
	MP56-01/6/6	Makaralı Kilit Karşılığı	...	50 Ad/ 1 Paket	
	MP28-02	(40,60,80,100,120) (140,160,180,200cm) 7,5 mm göbekli ispanyolet	...	50 Ad/ 1 Paket 30 Ad/ 1 Paket	
	MP32-34/3	İspanyolet Pim Takımı	...	200 Ad/ 1 Paket	
	MP33-09/4-3	Vasistas Makası	...	100 Ad/ 1 Paket	
	MP33-15/5	Cico Avrupa Vasistas Çitçit	...	50 Ad/ 1 Paket	
	MP32-33/1	Ayarlı Karşılık	...	500 Ad/ 1 Paket	
	TS 71	Kapı Hidroligi	...	10 Ad/ 1 Paket	
	MP33-04/2	Kapı Altı Fırçası	...	100 Ad/ 1 Paket	
	MP33-04/3	Y Kapı Alt Fırçası	...	100 Ad/ 1 Paket	
	MP26-05	Su Tahliye Tapası	...	2000 Ad/ 1 Paket	
	HE-9991	Pvc Tij	...	200 m / 1 Paket	

★ Yandaki profil birim ağırlıkları, bilgisayarda hesaplanmış teorik ağırlıklardır.

AKSESUAR KESİTİ	AKSESUAR KODU	AKSESUAR ADI	AĞIRLIK	PAKETLEME	SAYFA NO
	MP-9998	Kesme ve Delme Makinası	...	1 Ad/ Paket	

★ Yandaki profil birim ağırlıkları, bilgisayarla hesaplanmış teorik ağırlıklardır.

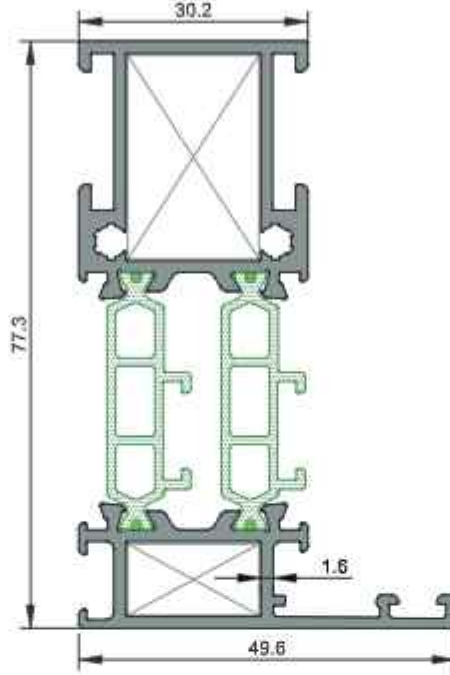

2909/10
Dar Kasa Profili
1,494 kg/m
$J_x=37,46 \text{ cm}^4$ $J_y=7,51 \text{ cm}^4$

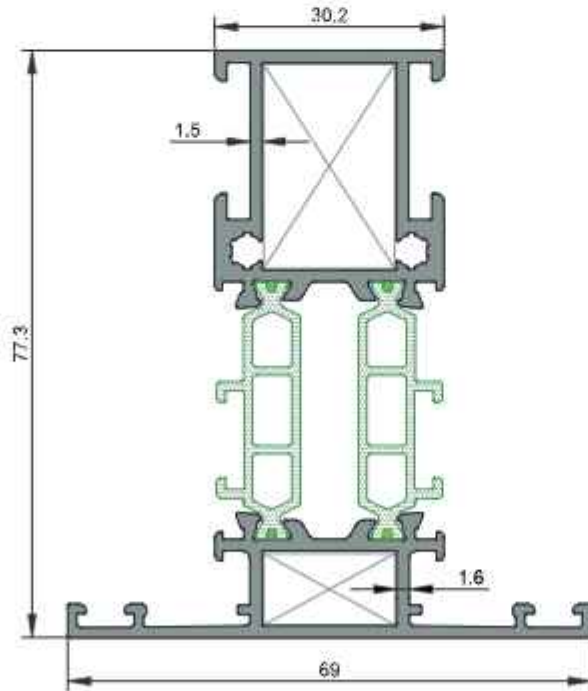

2909/13
Dar Orta Kayıt Profili
1,599 kg/m
$J_x=38,89 \text{ cm}^4$ $J_y=9,20 \text{ cm}^4$

★ Yandaki profil birim ağırlıkları, bilgisayarla hesaplanmış teorik ağırlıklardır.

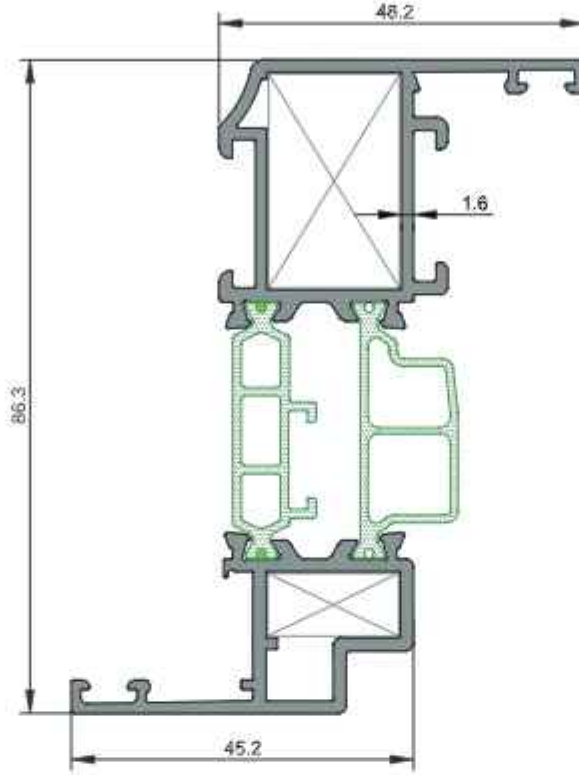

2911/12

Dar Kanat Profili

1,583 kg/m

$J_x=55,45 \text{ cm}^4$ $J_y=8,21 \text{ cm}^4$

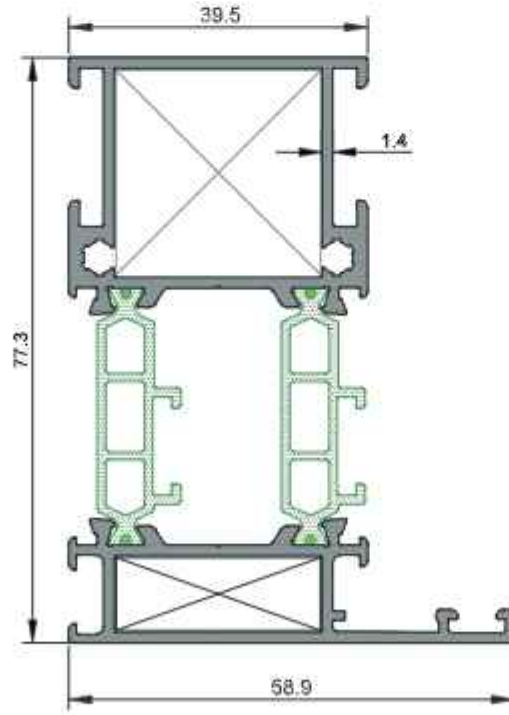

2650/51(1.4mm)

Geniş Kasa Profili

1,582 kg/m

$J_x=40,10 \text{ cm}^4$ $J_y=14,14 \text{ cm}^4$

★ Yandaki profil birim ağırlıkları, bilgisayarla hesaplanmış teorik ağırlıklardır.

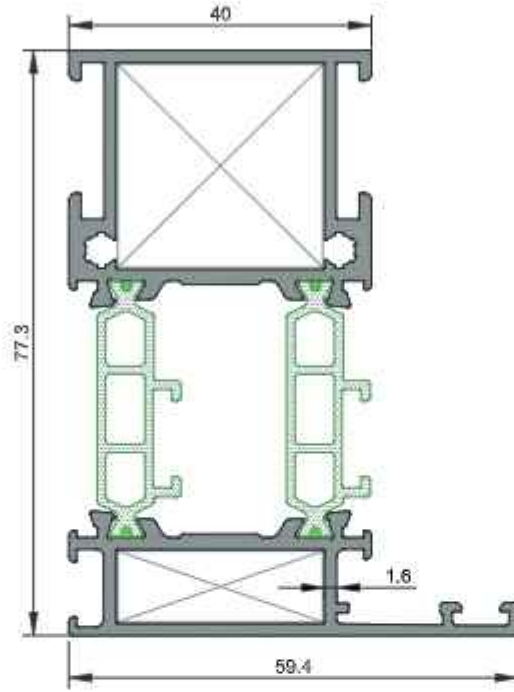

2650/51 (1.6mm)
Geniş Kasa Profili
1.681 kg/m
Jx=43,58 cm ⁴ Jy=15,20 cm ⁴

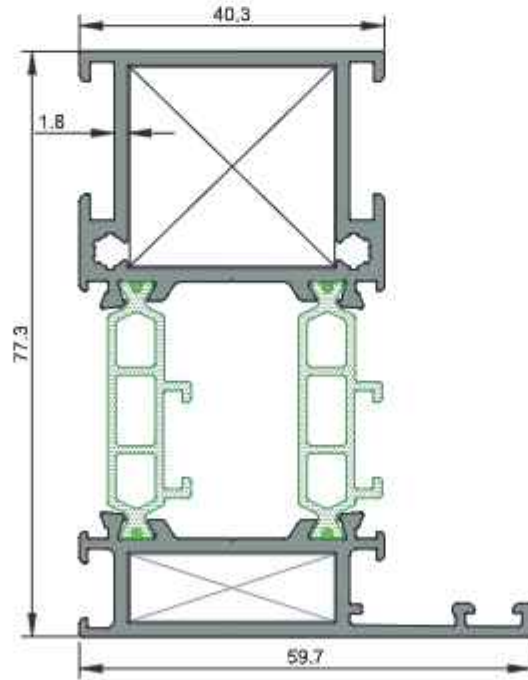

2650/51 (1.8mm)
Geniş Kasa Profili
1.770 kg/m
Jx=46,74 cm ⁴ Jy=15,82 m ⁴

★ Yandaki profil birim ağırlıkları, bilgisayarla hesaplanmış teorik ağırlıklardır.

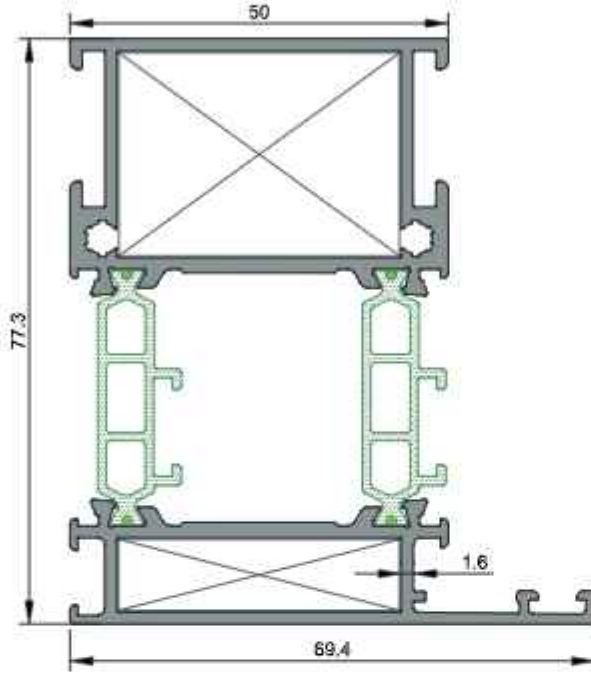

4452/53(1.6mm)
Geniş Kasa Profili
1,877 kg/m
$Jx=49,80 \text{ cm}^4$ $Jy=26,47 \text{ cm}^4$

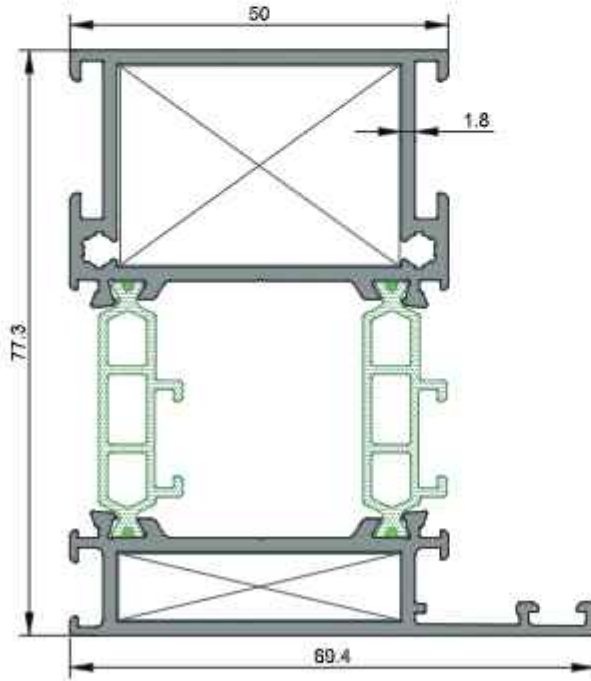

4452/53(1.8mm)
Geniş Kasa Profili
1,954 kg/m
$Jx=53,24 \text{ cm}^4$ $Jy=27,18 \text{ cm}^4$

★ Yandaki profil birim ağırlıkları, bilgisayarla hesaplanmış teorik ağırlıklardır.

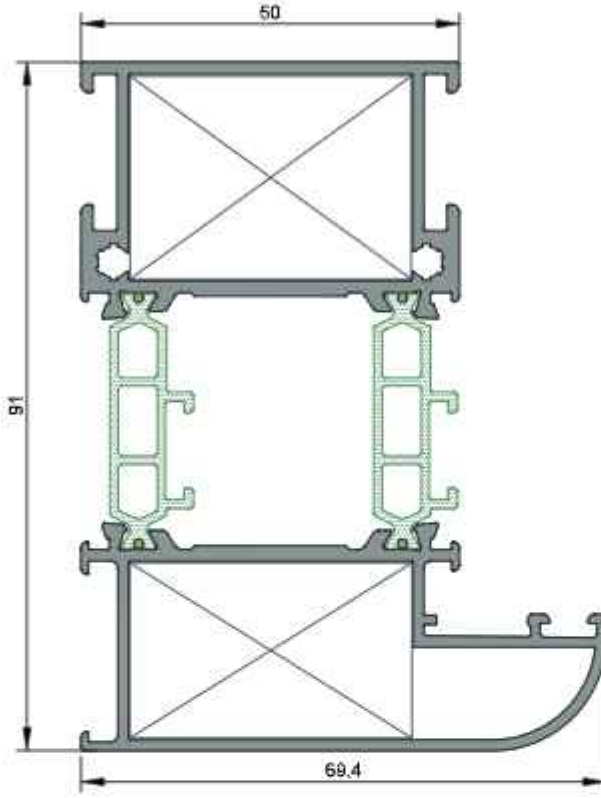

4718/4719

Oval Kasa Profili

2,020 kg/m

$J_x=67,02 \text{ cm}^4$ $J_y=30,50 \text{ cm}^4$

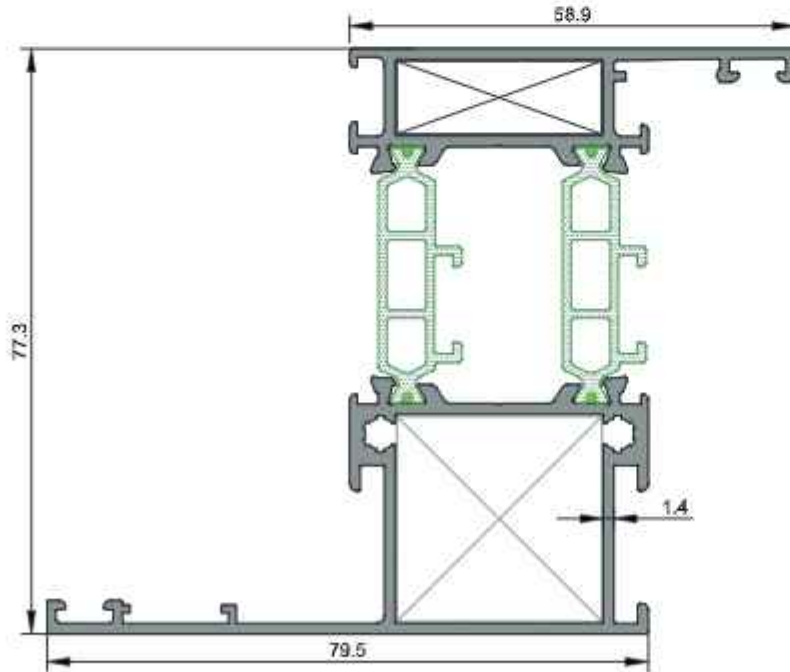

4894/4895

Pervaz Kasa Profili

1,744 kg/m

$J_x=57,83 \text{ cm}^4$ $J_y=20,05 \text{ cm}^4$

★ Yandaki profil birim ağırlıkları, bilgisayarda hesaplanmış teorik ağırlıklardır.

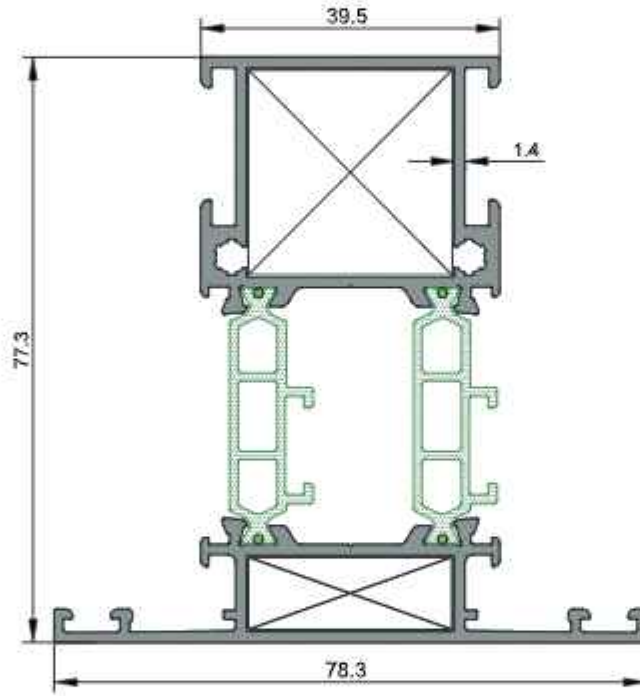

2651/52(1,4mm)
Geniş Orta Kayıt Profili
1,667 kg/m
Jx=41,12 cm ⁴ Jy=15,07 cm ⁴

★ Yandaki profil birim ağırlıkları, bilgisayarla hesaplanmış teorik ağırlıklardır.

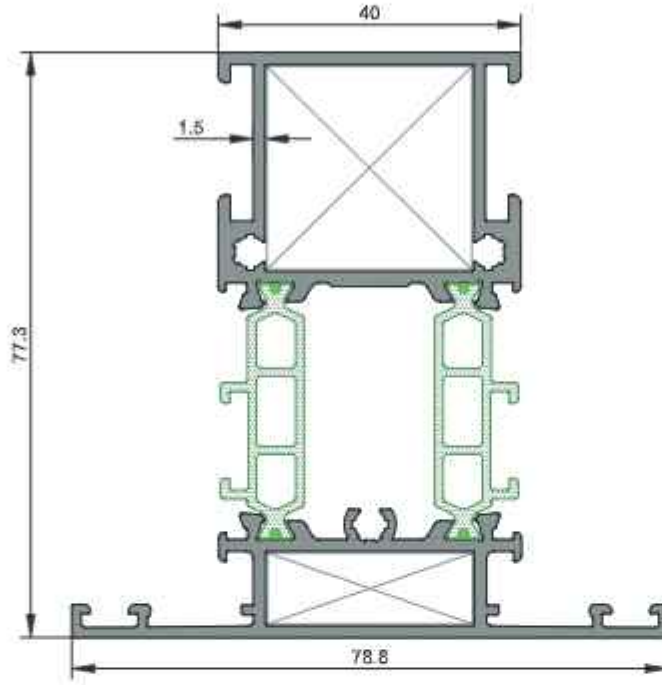

2651/52(1.6mm)
Geniş Orta Kayıt Profili
1,803 kg/m
Jx=44,80 cm ⁴ Jy=15,98 cm ⁴

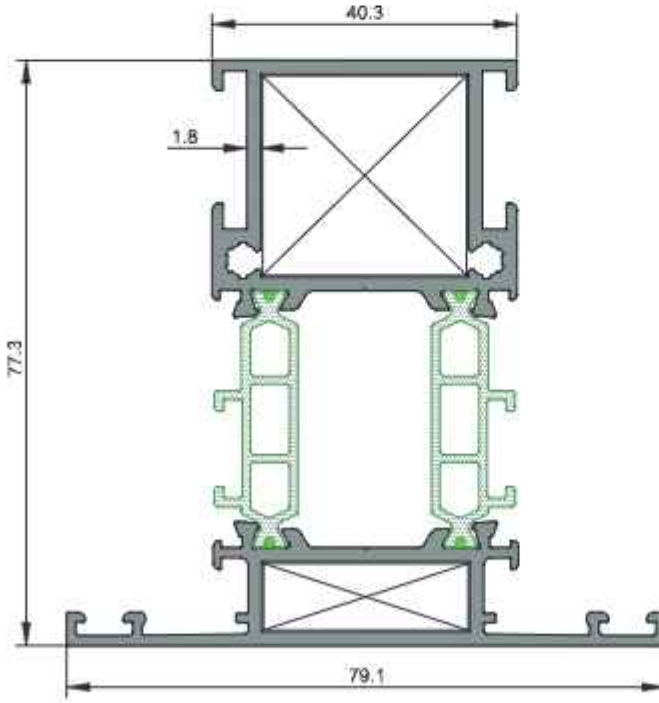

2651/52(1.8mm)
Geniş Orta Kayıt Profili
1,875 kg/m
Jx= 47,85 cm ⁴ Jy=16,52 cm ⁴

★ Yandaki profil birim ağırlıktan, bilgisayarda hesaplanmış hesaplanmış teorik ağırlıklardır.

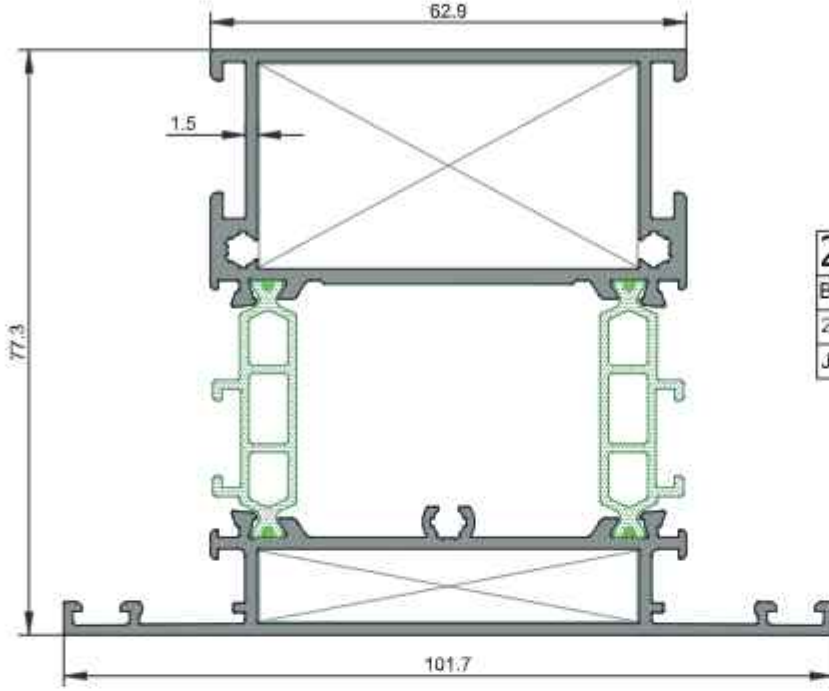

2933/34

Baza Orta Kayıt Profili

2,213 kg/m

Jx= 57,69 cm⁴ Jy=42,64 cm⁴

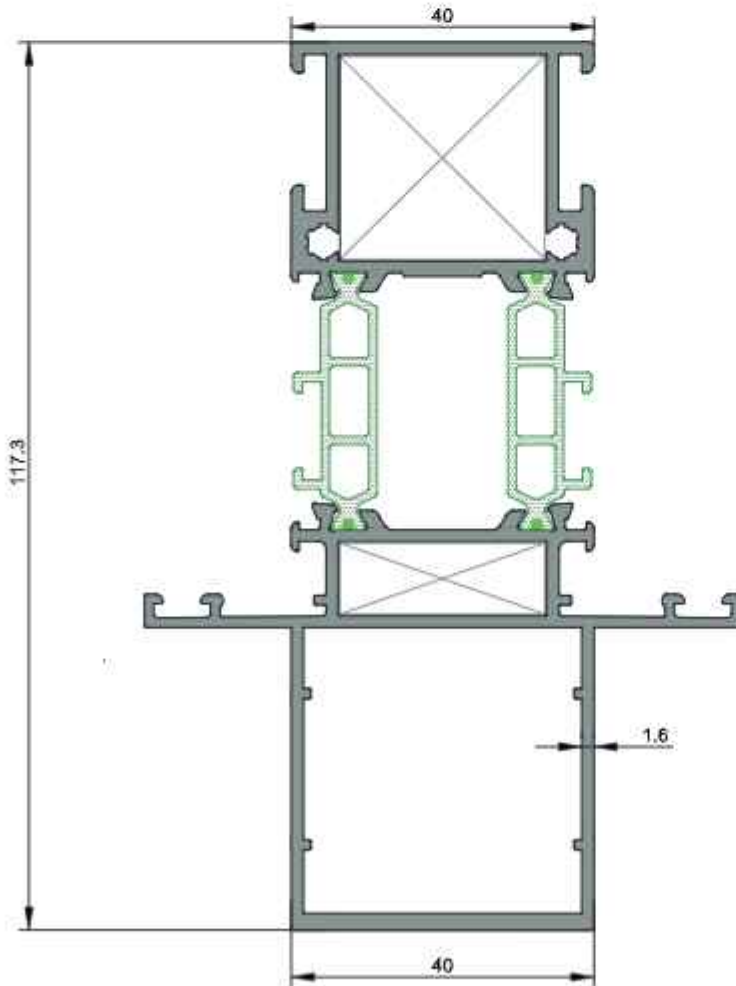

2651/4513

Takviyeli Orta Kayıt Profili

2,355 kg/m

Jx=110,65 cm⁴ Jy=25,68 cm⁴

★ Yandaki profil birim ağırlıkları, bilgisayarla hesaplanmış teorik ağırlıklardır.

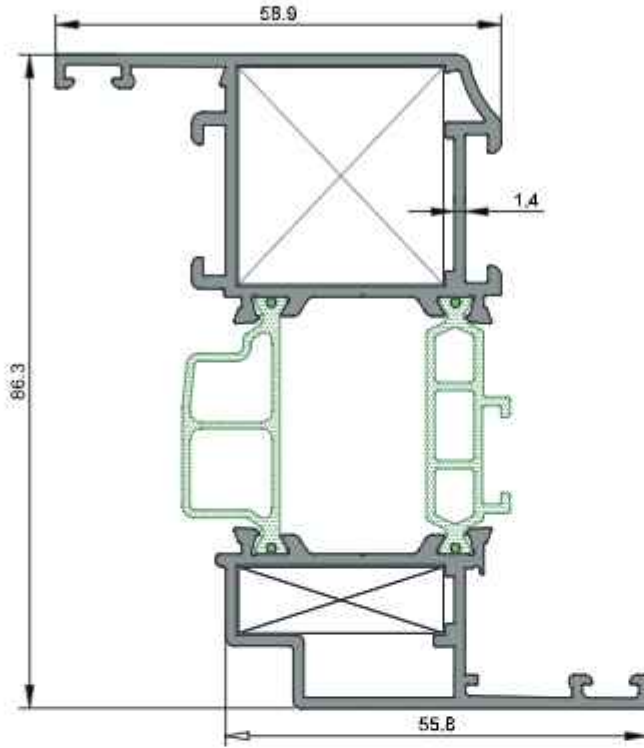

2653/54(1.4mm)
Geniş Kanat Profili
1,677 kg/m
Jx= 58,52 cm ⁴ Jy=16,28 cm ⁴

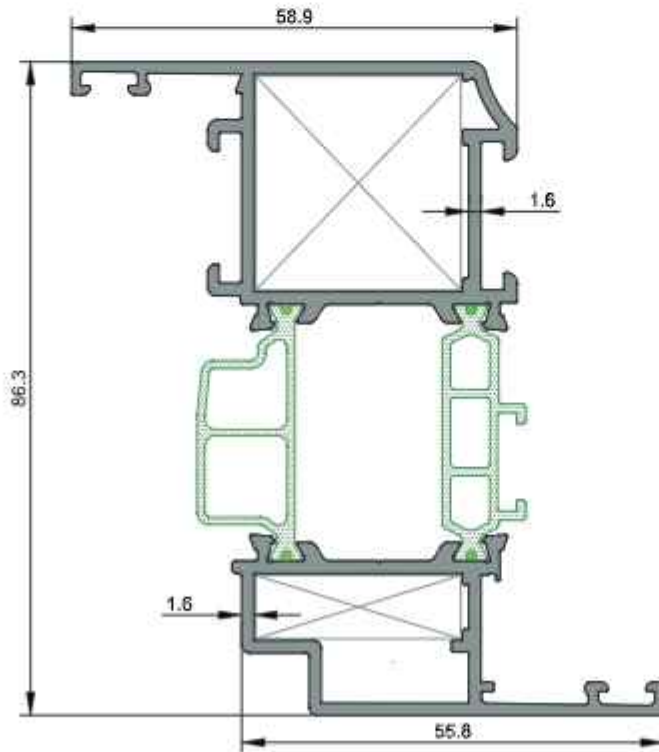

2653/54(1.6mm)
Geniş Kanat Profili
1,780 kg/m
Jx= 62,06 cm ⁴ Jy=16,99 cm ⁴

★ Yandaki profil birim ağırlıkları, bilgisayarla hesaplanmış teorik ağırlıklardır.

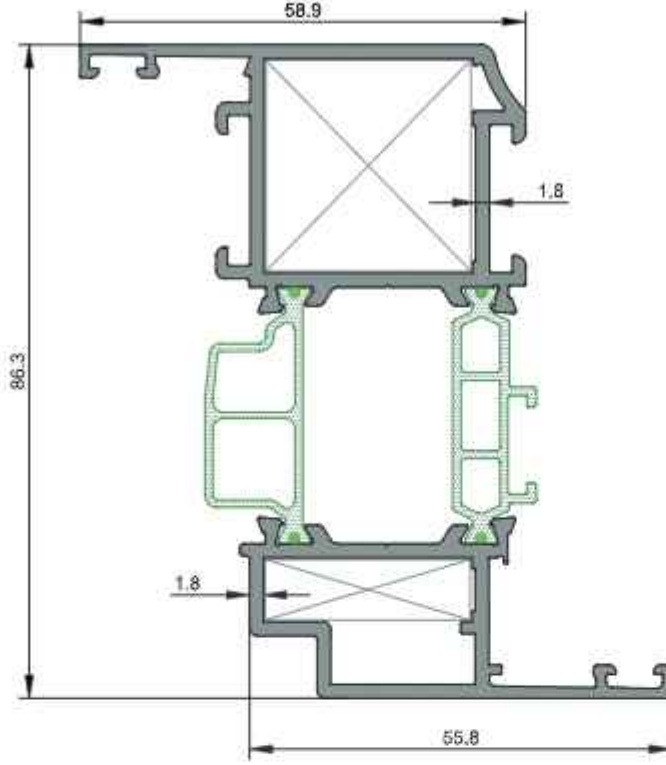

2653/54(1.8mm)
Geniş Kanat Profili
1,884 kg/m
Jx= 53,29 cm ⁴ Jy=17,65 cm ⁴

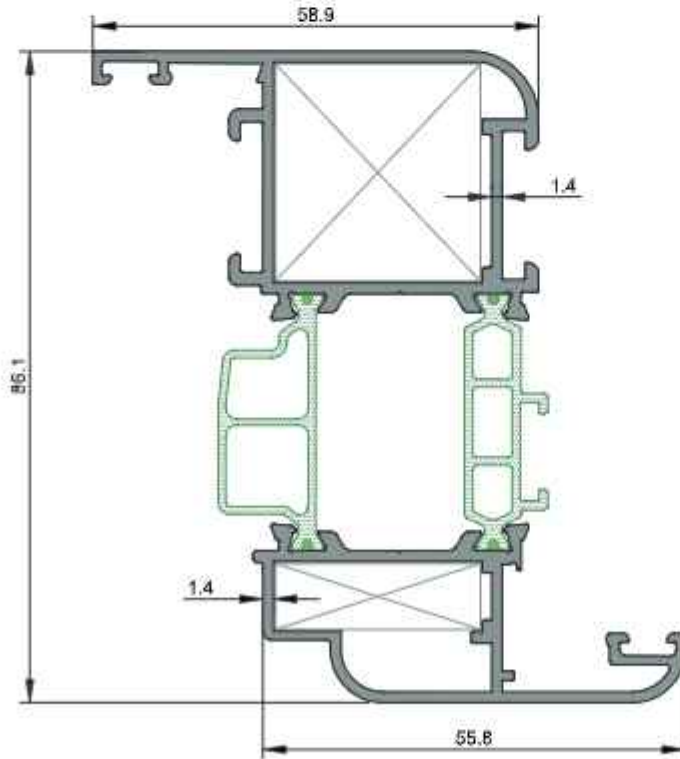

4720/4721
Oval Kanat Profili
1,686 kg/m
Jx=59,10 cm ⁴ Jy=16,67 cm ⁴

★ Yandaki profil birim ağırlıkları, bilgisayarla hesaplanmış teorik ağırlıklardır.

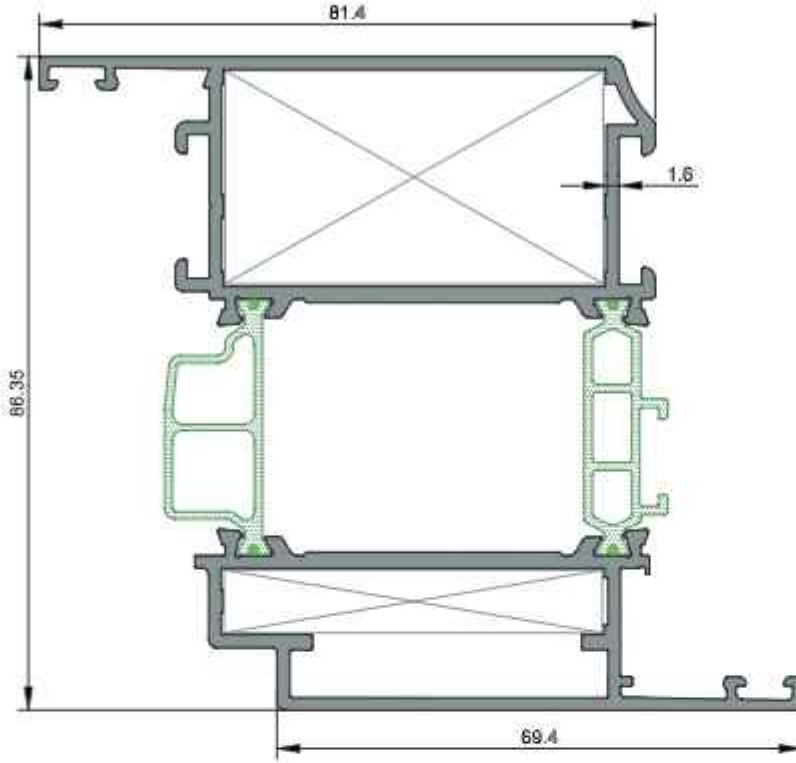

2661/62(1.6mm)
Kapı Kanat Profili
2,317 kg/m
Jx=86,27 cm ⁴ Jy=48,41 cm ⁴

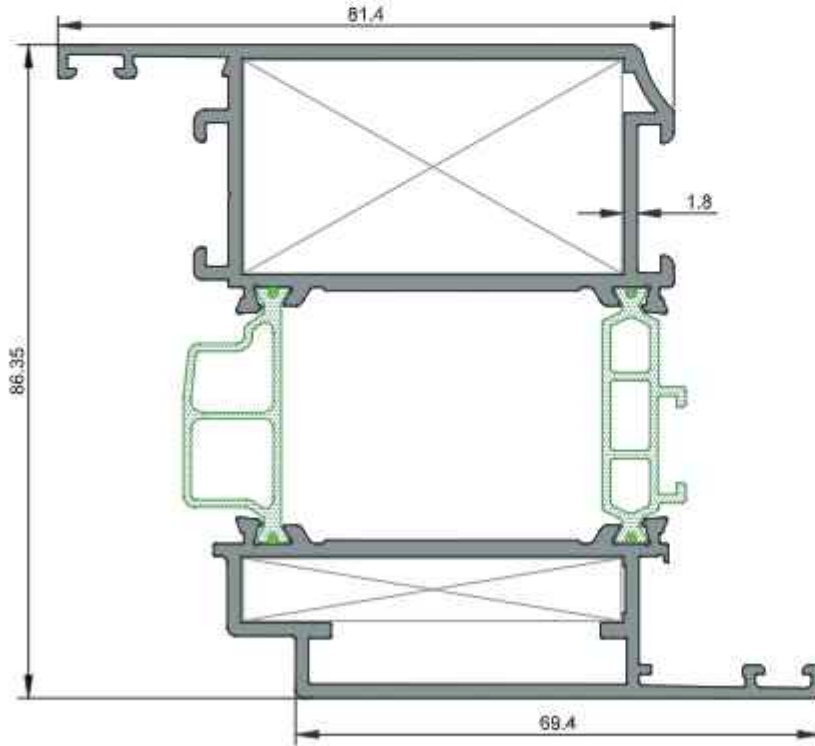

2661/62(1.8mm)
Kapı Kanat Profili
2,381 kg/m
Jx= 89,10 cm ⁴ Jy= 49,53 cm ⁴

★ Yandaki profil birim ağırlıkları, bilgisayarda hesaplanmış teorik ağırlıklardır.

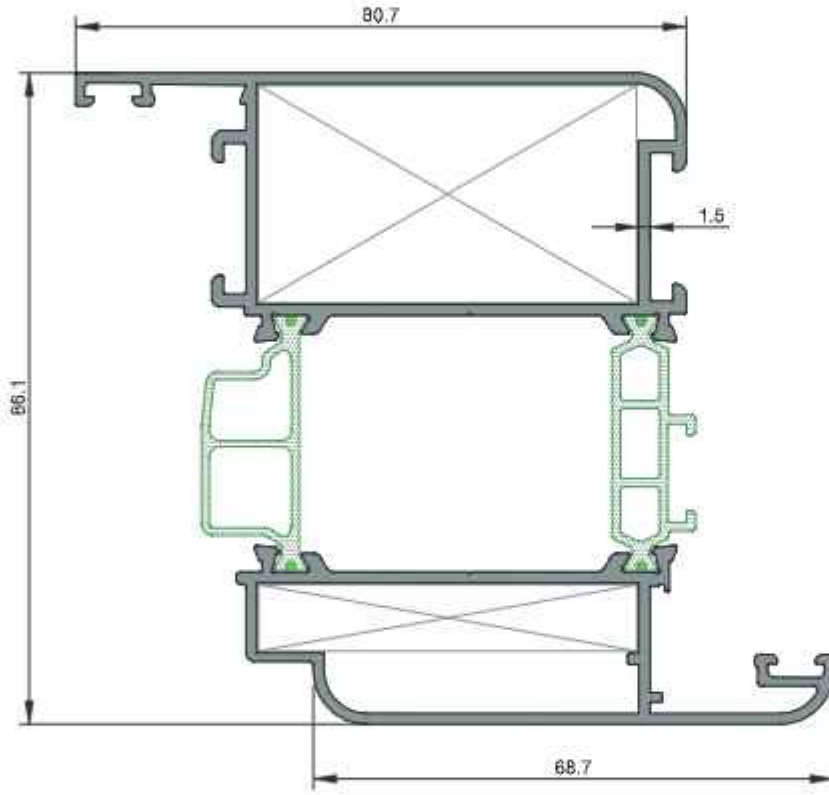

4722/4723
Oval Kapı Kanat Profili
2,003 kg/m
$J_x=79,74 \text{ cm}^4$ $J_y=41,87 \text{ cm}^4$

★ Yandaki profil birim ağırlıkları, bilgisayarla hesaplanmış teorik ağırlıklardır.

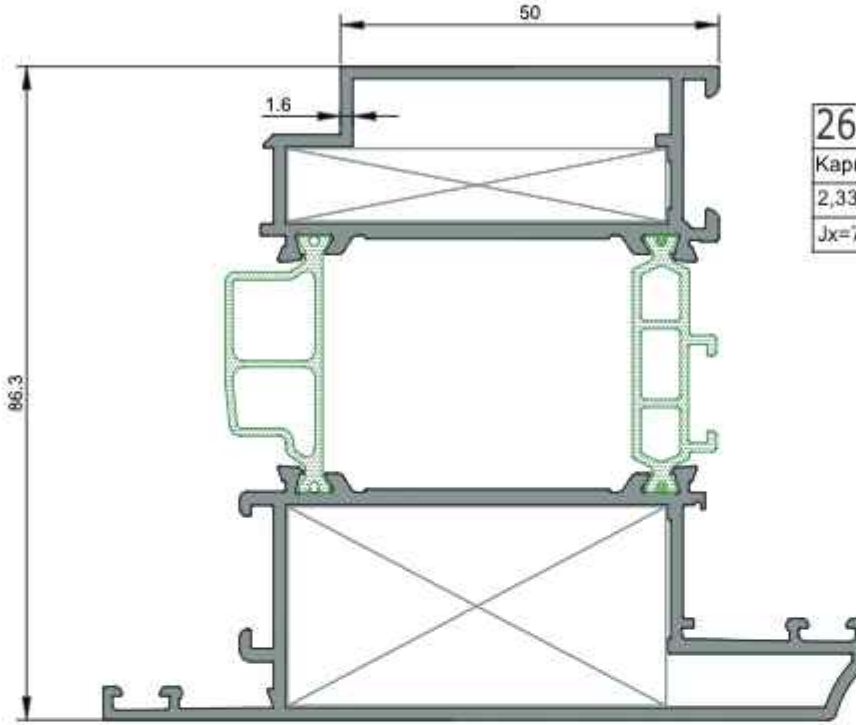

2663/64(1.6mm)
Kapı Kanat Profili(Dışa Açılır)
2,332 kg/m
Jx=77,26 cm ⁴ Jy=61,31 cm ⁴

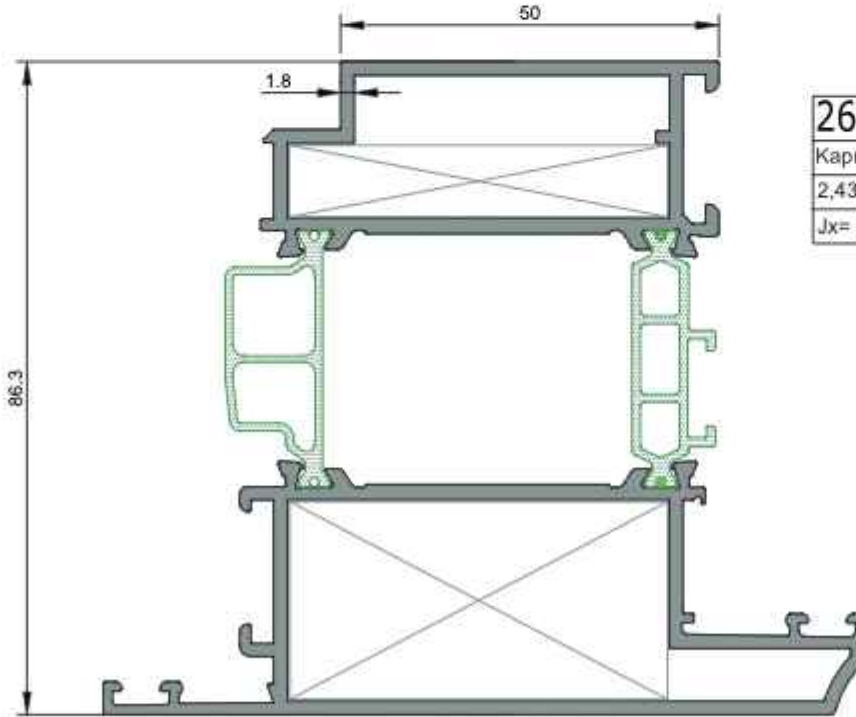

2663/64(1.8mm)
Kapı Kanat Profili(Dışa Açılır)
2,439 kg/m
Jx= 82,74 cm ⁴ Jy=63,29 cm ⁴

★ Yandaki profil birim ağırlıkları, bilgisayarda hesaplanmış teorik ağırlıklardır.

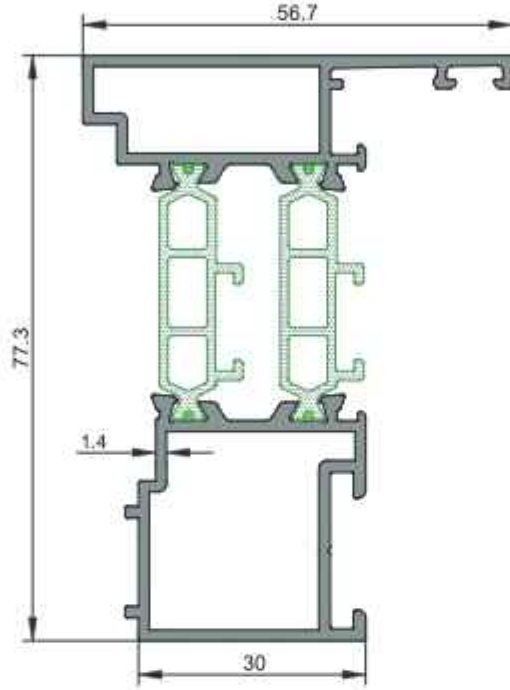

2659/60
Dışa Açılır Çift Kanat Adaptörü
1,403 kg/m
Jx=35,69 cm ⁴ Jy=8,84 cm ⁴

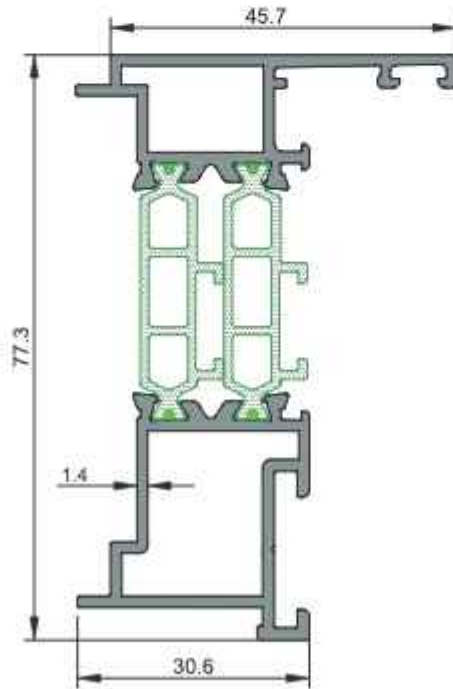

2655/56
Dışa Açılır Kapı Adaptörü
1,303 kg/m
Jx=31,96 cm ⁴ Jy=5,25 cm ⁴

★ Yandaki profil birim ağırlıkları, bilgisayarla hesaplanmış teorik ağırlıklardır.

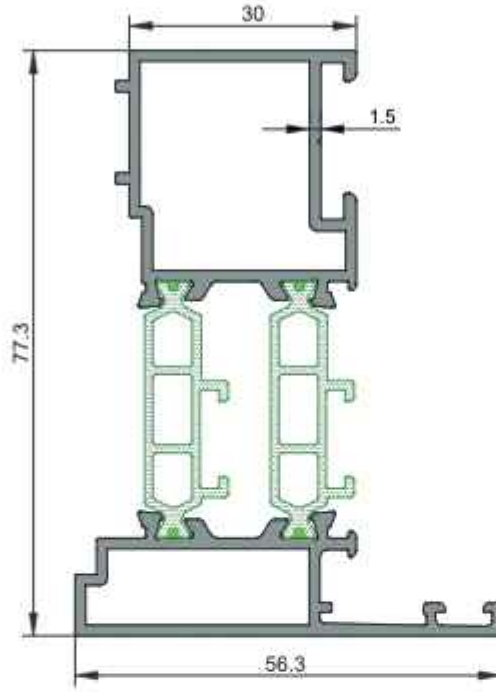

2815/16
İçe Açılır Çift Kanat Adaptörü
1,404 kg/m
Jx=35,88 cm ⁴ Jy=8,96 cm ⁴

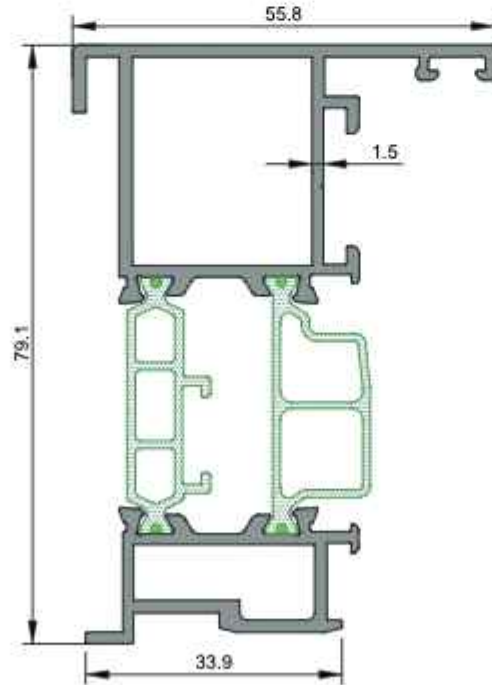

4899/4900
Pivot Kanat Adaptörü
1,502 kg/m
Jx=42,86 cm ⁴ Jy=10,37 cm ⁴

1909/10
Etek Profili
2,298 kg/m
Jx=70,14 cm ⁴ Jy=57,58 cm ⁴

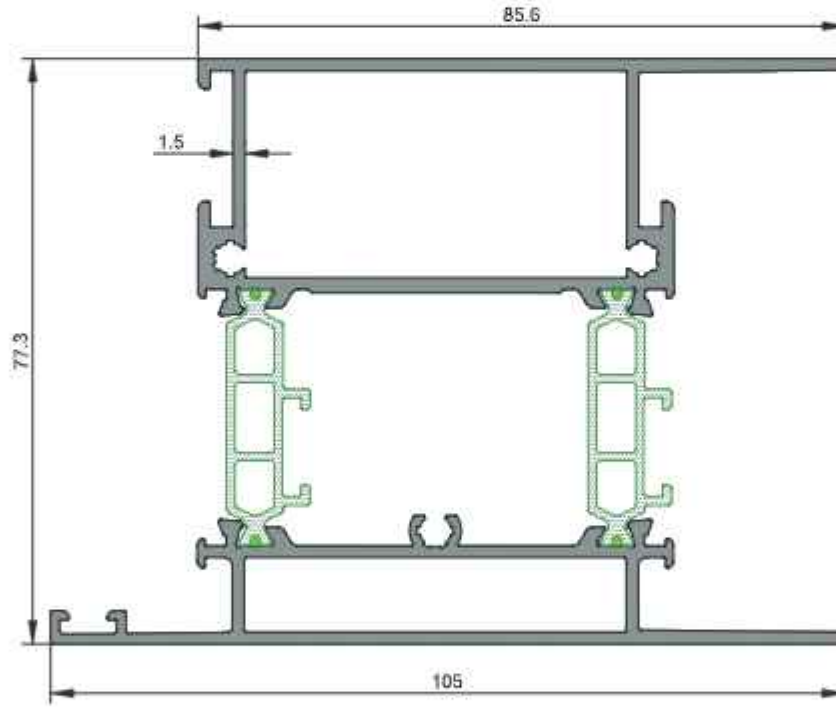

★ Yandaki profil birim ağırlıkları, bilgisayarda hesaplanmış teorik ağırlıklardır.

★ Yandaki profil birim ağırlıkları, bilgisayarda hesaplanmış teorik ağırlıklardır.

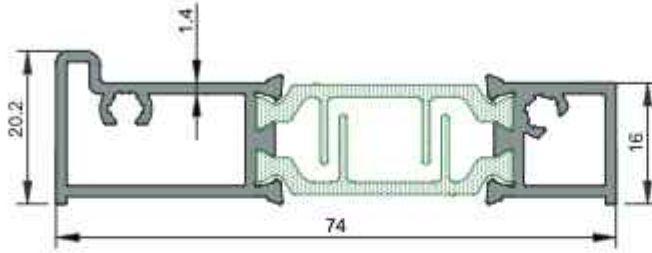

2935/36
Eşik Profili
0,948 kg/m
Jx=20,96 cm ⁴ Jy=1,38 cm ⁴

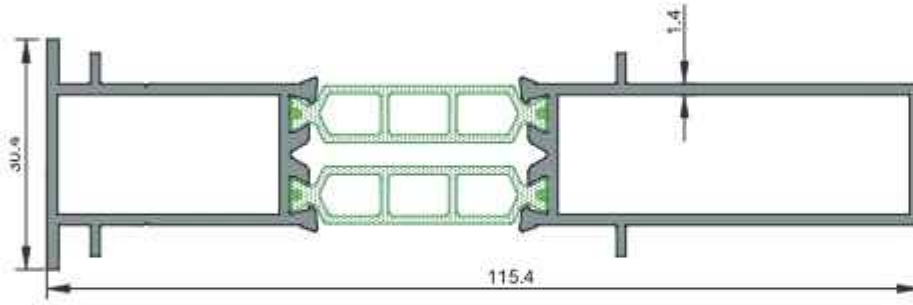

3141/42
Ek Profili
1,344 kg/m
Jx=62,69 cm ⁴ Jy=3,30 cm ⁴

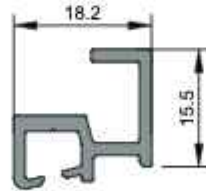

4120
Eşik-Kanat Adaptör Profili (İç)
0,245 kg/m

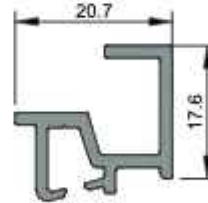

4121
Eşik-Kanat Adaptör Profili (Dış)
0,279 kg/m

★ Yandaki profil birim ağırlıkları, bilgisayarda hesaplanmış teorik ağırlıklardır.

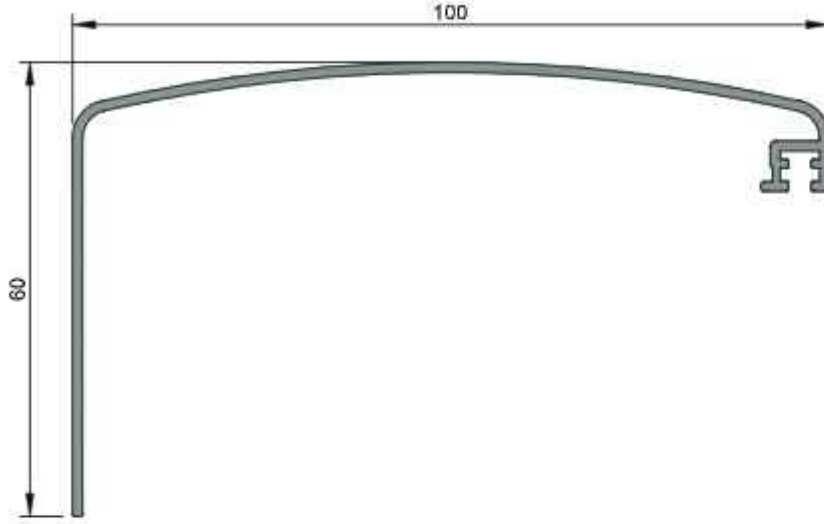

2260
Pervaz
0,625 kg/m

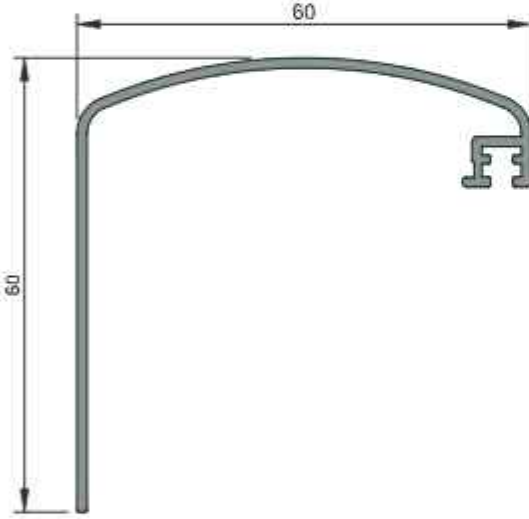

2259
Pervaz
0,486 kg/m

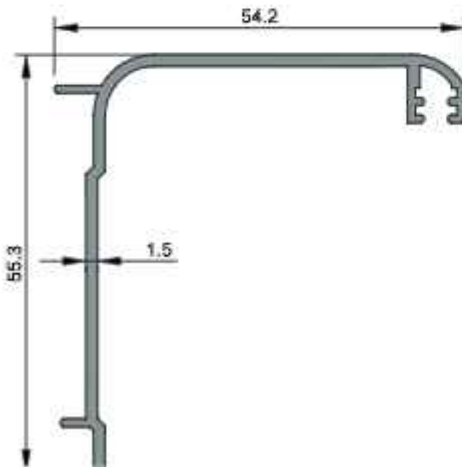

4898
Pervaz
0,481 kg/m

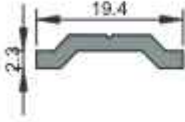

1210
İspanyollet Çubuğu
0,112 kg/m

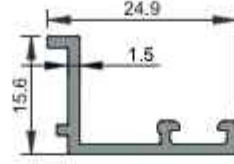

2666
Dış Tımak
0,181 kg/m

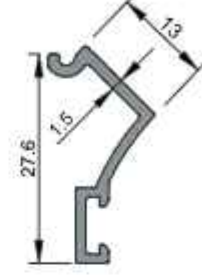

2667
Köşe Dönüş Adaptörü İç
0,179 kg/m

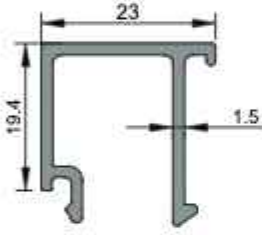

4124
Cam Çıtası
0,308 kg/m

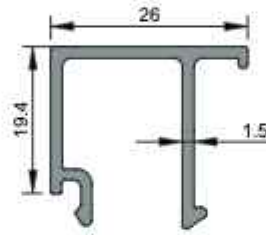

2668
Cam Çıtası
0,320 kg/m

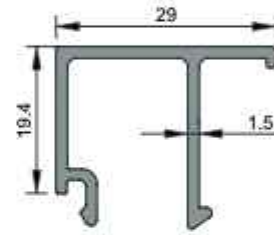

2657
Cam Çıtası
0,332 kg/m

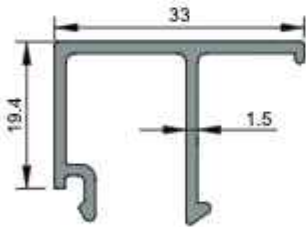

2914
Cam Çıtası
0,349 kg/m

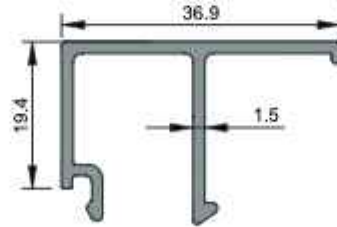

3136
Cam Çıtası
0,364 kg/m

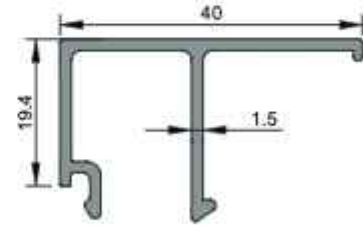

3183
Cam Çıtası
0,377 kg/m

★ Yandaki profil birim ağırlıkları, bilgisayarda hesaplanmış teorik ağırlıklardır.

★ Yandaki profil birim ağırlıkları, bilgisayarda hesaplanmış teorik ağırlıklardır.

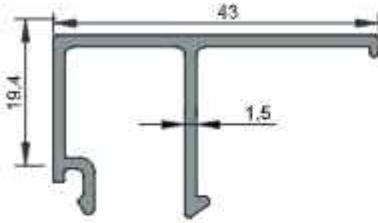

4122
Cam Çıtası
0,390 kg/m

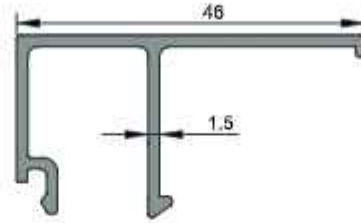

4123
Cam Çıtası
0,402 kg/m

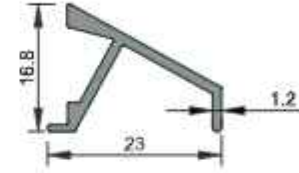

2181
Damlalık Profil
0,168 kg/m

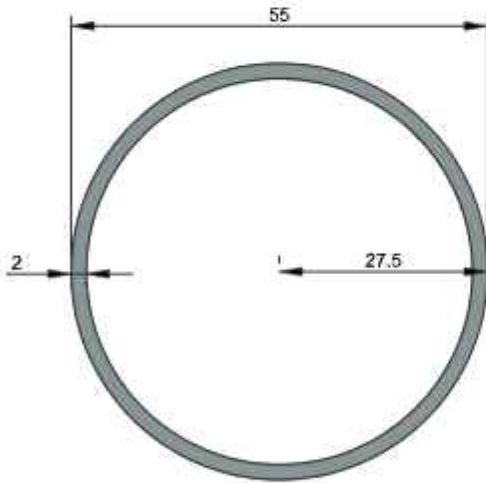

2150
55'lik Boru Profili
0,902 kg/m

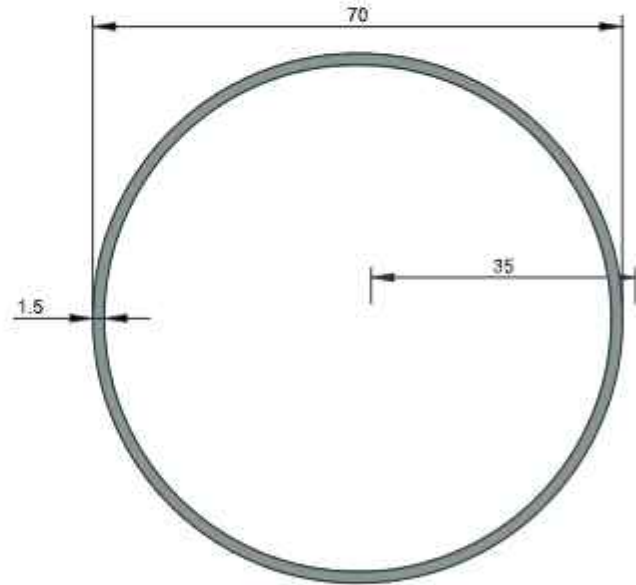

2000
70'lik Boru
0,875 kg/m

ÇEKTİRME TAKOZU KESİM ÖLÇÜLERİ

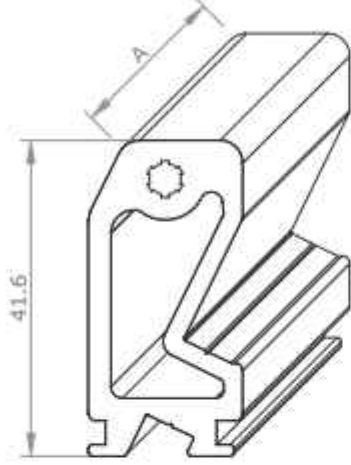

4125
Çektirme Takozu
1,099 kg/m

Aksesuar Kodu	Profil Kodu	Kesim Ölçüsü A(mm)
C4125 271	2651/52	27.1
C4125 173	2909/13	17.3

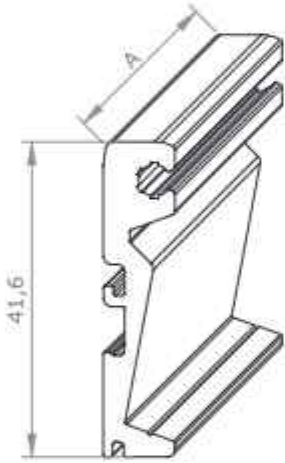

4133
Çektirme Takozu
0,566 kg/m

Aksesuar Kodu	Profil Kodu	Kesim Ölçüsü A(mm)
C4133 271	2651/52	27.1
C4133 173	2909/13	17.3

★ Yandaki profil birim ağırlıkları, bilgisayarla hesaplanmış teorik ağırlıklardır.

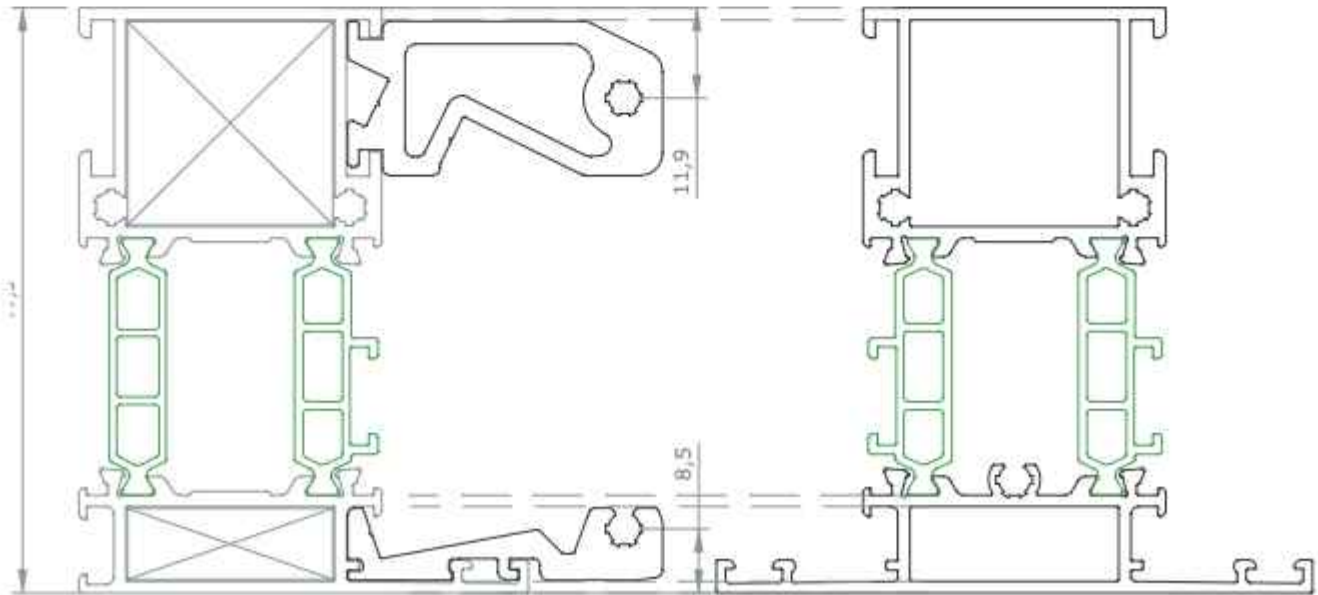

ORTA KAYIT KERTME DETAYI

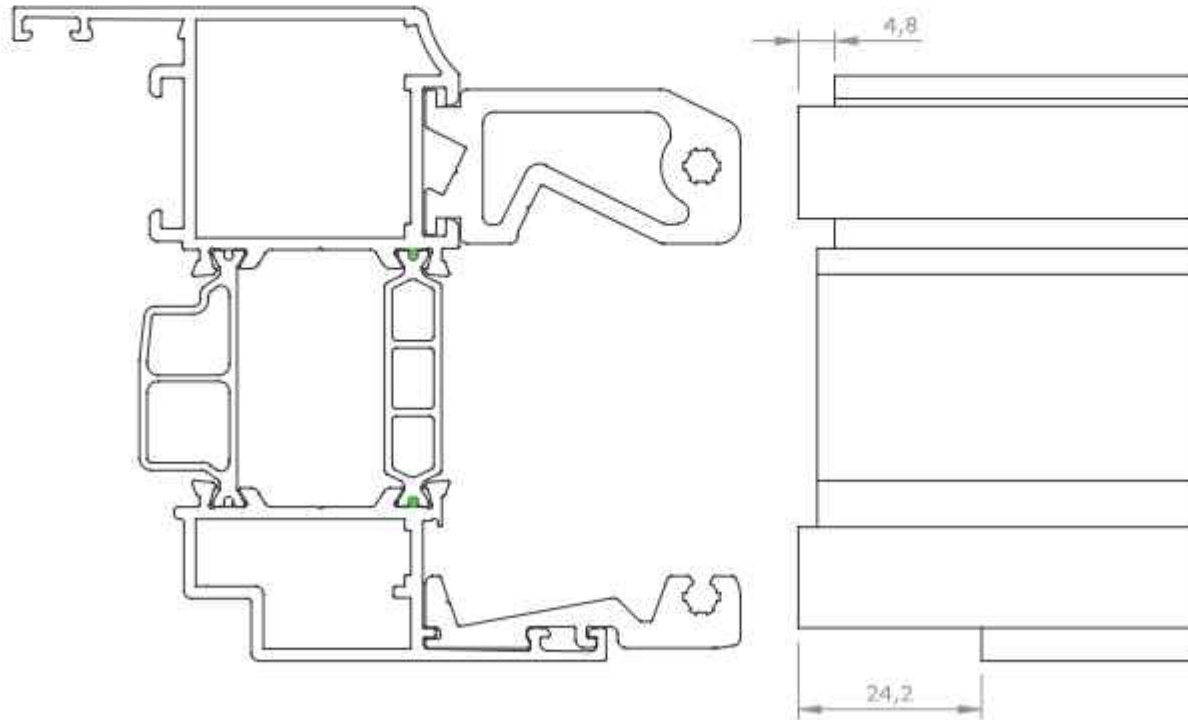
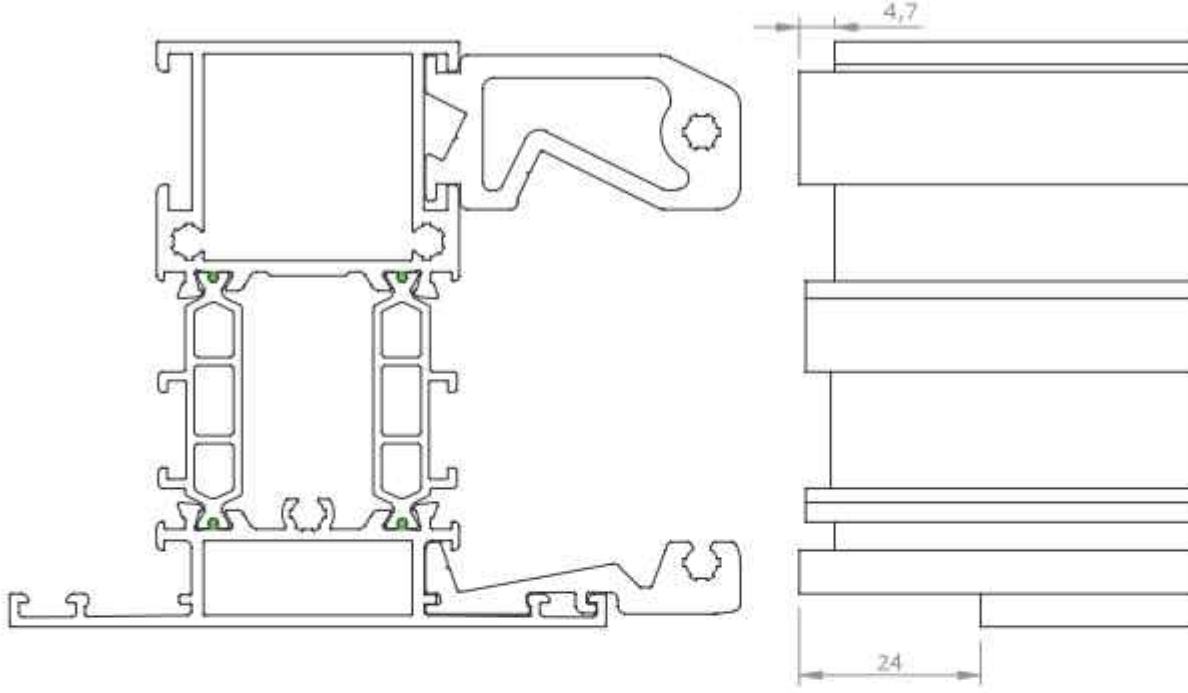

★ Yandaki profil birim ağırlıkları, bilgisayarda hesaplanmış teorik ağırlıklardır.

KÖŞE TAKOZU KESİM ÖLÇÜLERİ

3545

Köşe Takozu

4,616 kg/m

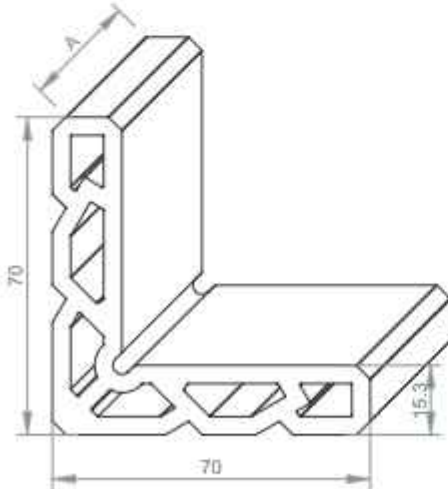
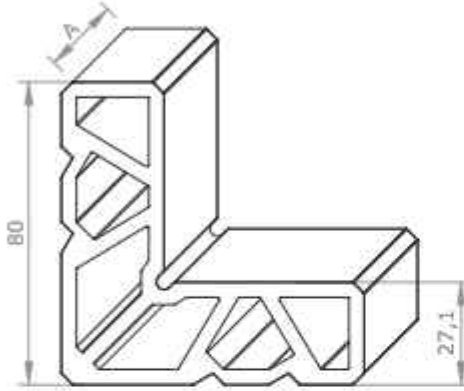

Aksesuar Kodu	Profil Kodu	Kesim Ölçüsü A(mm)
K3545 271	2650/2651-1,4	27.1
K3545 096	2650/2651-1,4	9.6
K3545 268	2650/2651-1,6	26.8
K3545 094	2650/2651-1,6	9.4
K3545 263	2650/2651-1,8	26.3
K3545 088	2650/2651-1,8	8.8
K3545 271	2651/2652-1,4	27.1
K3545 096	2651/2652-1,4	9.6
K3545 268	2651/2652-1,6	26.8
K3545 094	2651/2652-1,6	9.4
K3545 263	2651/2652-1,8	26.3
K3545 088	2651/2652-1,8	8.8
K3545 287	2653/2654-1,4	28.7
K3545 088	2653/2654-1,4	8.8
K3545 283	2653/2654-1,6	28.3
K3545 083	2653/2654-1,6	8.3
K3545 279	2653/2654-1,8	27.9
K3545 080	2653/2654-1,8	8.0
K3545 263	4452/4453-1,4	26.3
K3545 088	4452/4453-1,4	8.8
K3545 263	4452/4453-1,8	26.3
K3545 088	4452/4453-1,8	8.8
K3545 268	4718/4719	26.8
K3545 231	4718/4719	23.1
K3545 268	2651/4513	26.8
K3545 231	2651/4513	23.1
K3545 287	4720/4721	28.7
K3545 087	4720/4721	8.7
K3545 088	2654	8.8

2929

Köşe Takozu

3,341 kg/m

Aksesuar Kodu	Profil Kodu	Kesim Ölçüsü A(mm)
K2929 297	3478/3479	29.7
K2929 080	3478/3479	8.0

★ Yandaki profil birim ağırlıkları, bilgisayarda hesaplanmış teorik ağırlıklardır.

KÖŞE TAKOZU KESİM ÖLÇÜLERİ

★ Yandaki profil birim ağırlıkları, bilgisayarda hesaplanmış teorik ağırlıklardır.

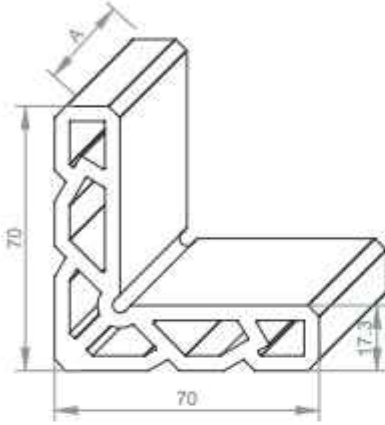

2917
Köşe Takozu
3,469 kg/m

Aksesuar Kodu	Profil Kodu	Kesim Ölçüsü A(mm)
K2917 268	2909/2910	26.8
K2917 094	2909/2910	9.4
K2917 268	2909/2913	26.8
K2917 094	2909/2913	9.4
K2917 283	2911/2912	28.3
K2917 083	2911/2912	8.3
K2917 377	2932	37.7

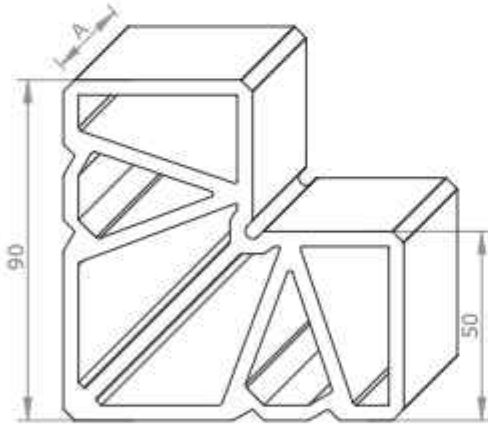

3546
Köşe Takozu
6,304 kg/m

Aksesuar Kodu	Profil Kodu	Kesim Ölçüsü A(mm)
K3546 263	2663/2664-1,6	26.3
K3546 096	2663/2664-1,6	9.6
K3546 261	2663/2664-1,8	26.1
K3546 094	2663/2664-1,8	9.4
K3546 283	2661/2662-1,6	28.3
K3546 083	2661/2662-1,6	8.3
K3546 284	2661/2662-1,8	28.4
K3546 085	2661/2662-1,8	8.5
K3546 297	3483/3484	29.7
K3546 080	3483/3484	8.0
K3546 268	2933/2934	26.8
K3546 080	2933/2934	8.0
K3546 377	4722/4723	37.7
K3546 088	4722/4723	8.8

ÖLÇEK:1/1

★ Yandaki profil birim ağırlıkları, bilgisayarda hesaplanmış teorik ağırlıklardır.

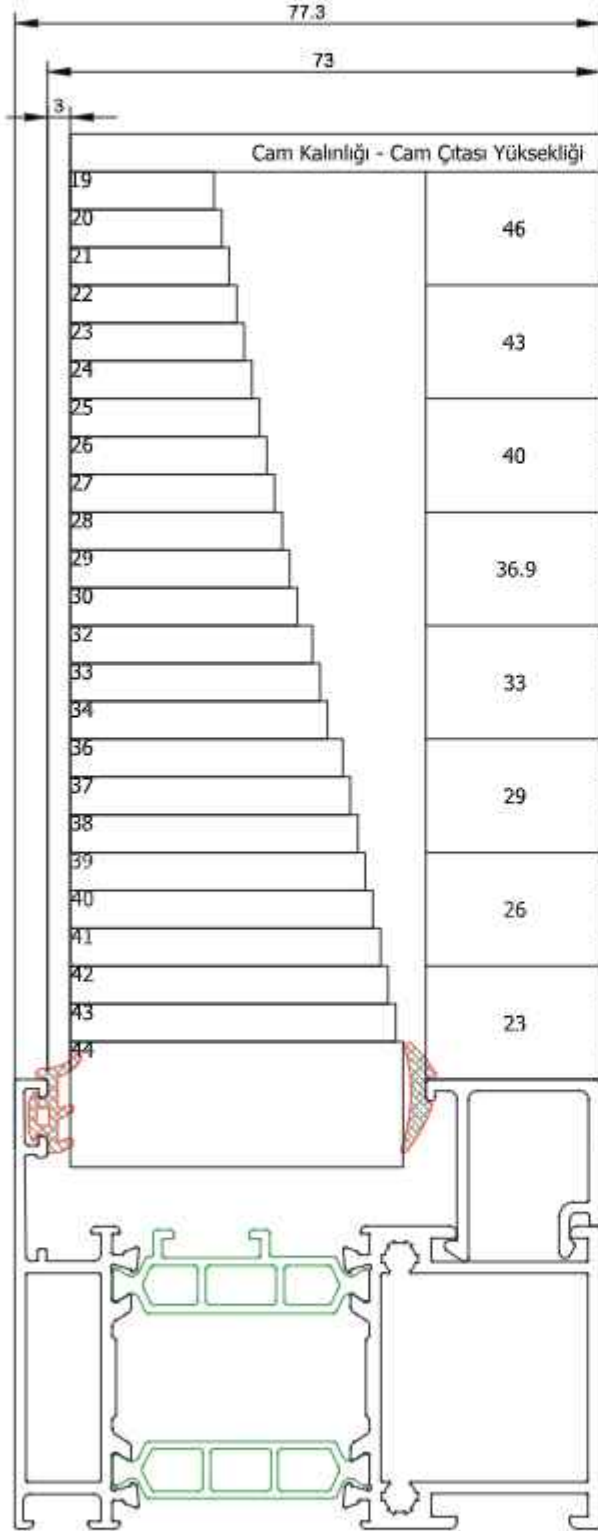

Cam Kalınlığı - Cam Çıtası Yüksekliği	Fıtlı Kodu	Profil
46	HL 07	4123
	HL 04	
	HL 31	
43	HL 07	4122
	HL 04	
	HL 31	
40	HL 07	3183
	HL 04	
	HL 31	
36.9	HL 07	3136
	HL 04	
	HL 31	
33	HL 07	2914
	HL 04	
	HL 31	
29	HL 07	2657
	HL 04	
	HL 31	
26	HL 07	2668
	HL 04	
	HL 31	
23	HL 07	4124
	HL 04	
	HL 31	

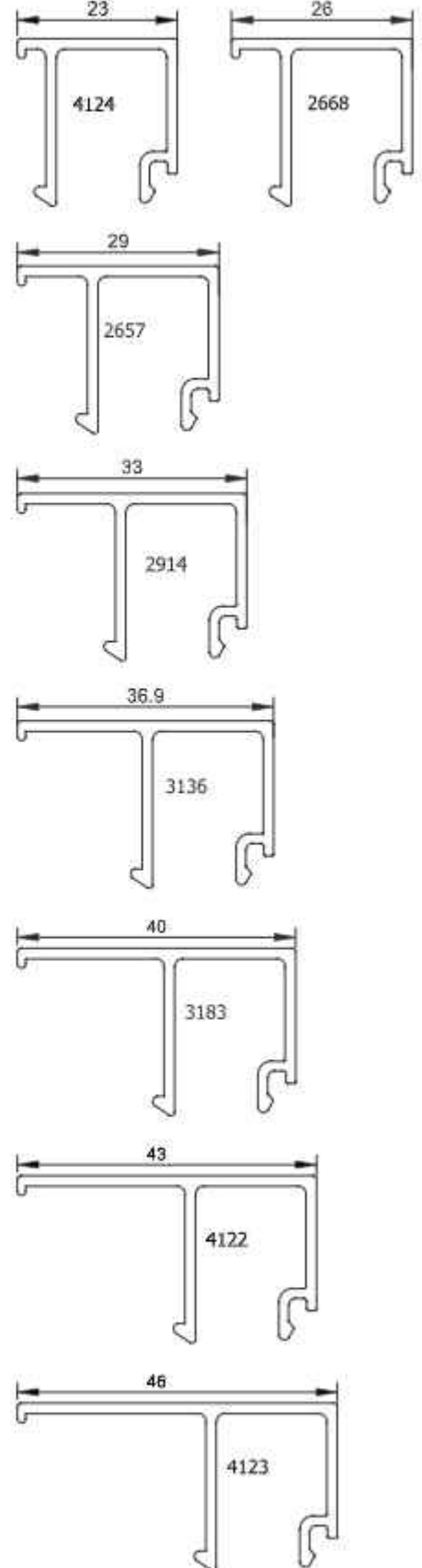

ÖLÇEK:1/1

★ Yandaki profil birim ağırlıkları, bilgisayarda hesaplanmış teorik ağırlıklardır.

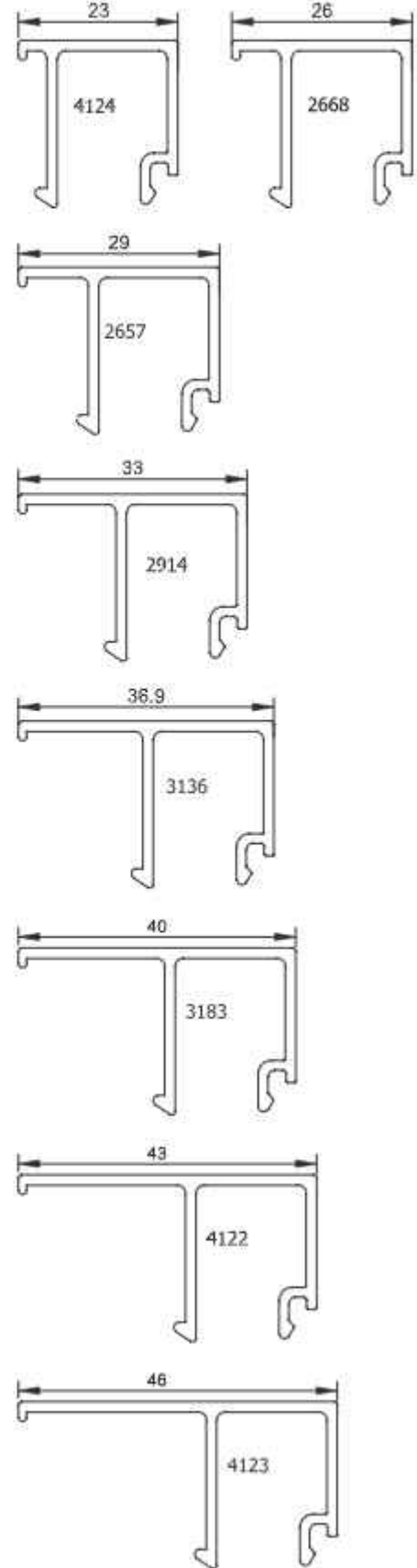
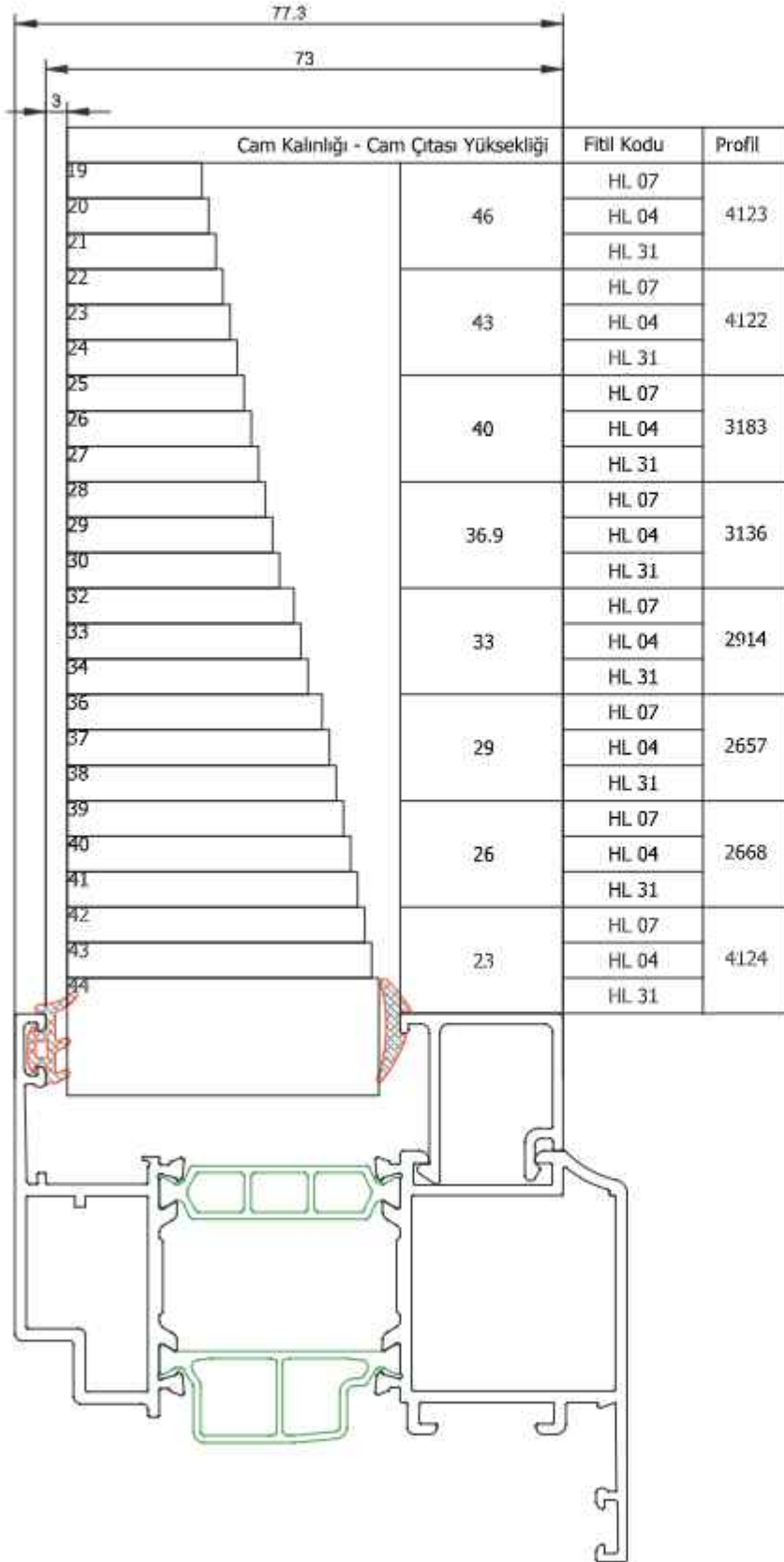

ÖLÇEK:1/1

★ Yandaki profil birim ağırlıkları, bilgisayararda hesaplanmış teorik ağırlıklardır.

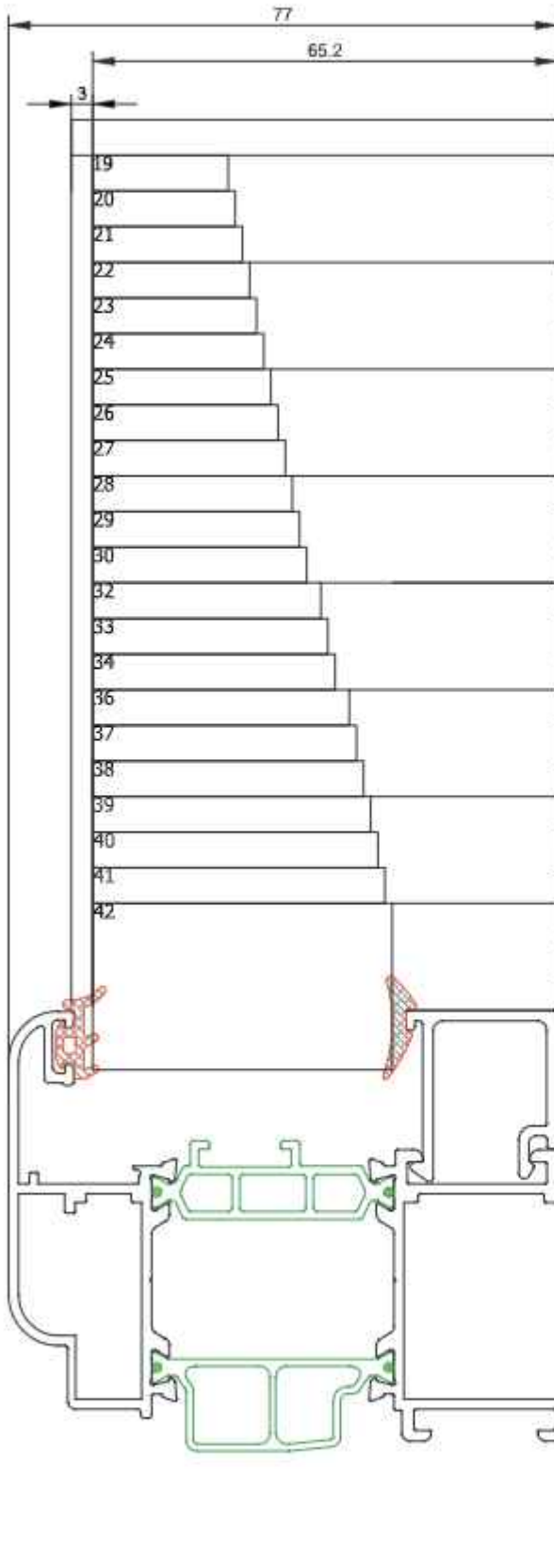

Fitil Kodu	Profil
HL 07	4123
HL 04	
HL 31	
HL 07	4122
HL 04	
HL 31	
HL 07	3183
HL 04	
HL 31	3136
HL 07	
HL 04	
HL 07	2914
HL 04	
HL 31	
HL 07	2657
HL 04	
HL 31	2668
HL 04	
HL 07	4124
HL 04	
HL 31	

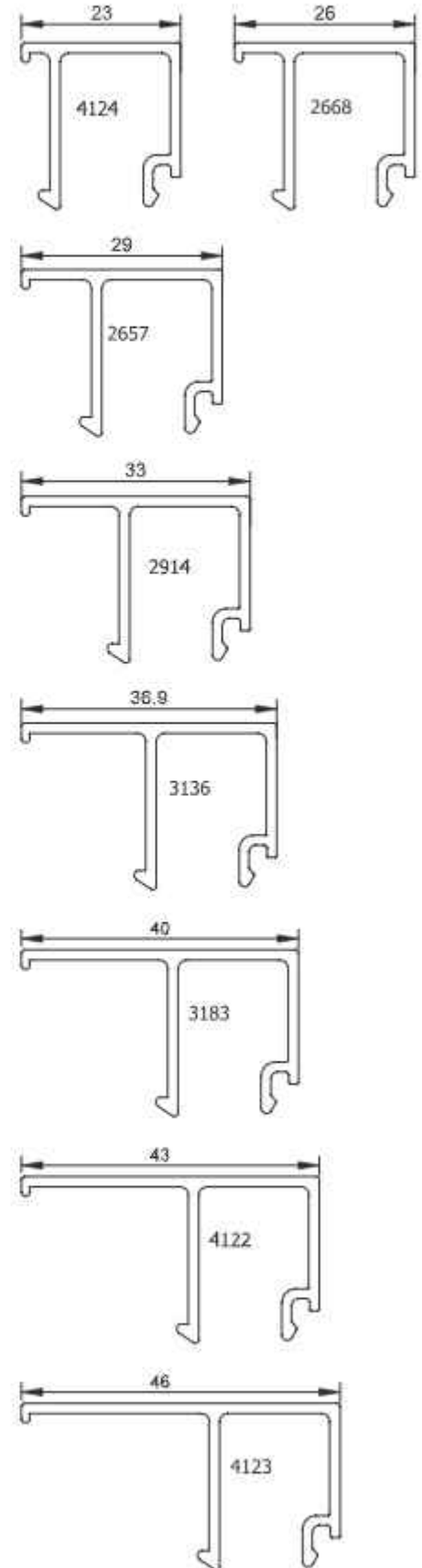

PENCERE UYGULAMA TİPLERİ

★ Yandaki profil birim ağırlıkları, bilgisayarda hesaplanmış teorik ağırlıklardır.

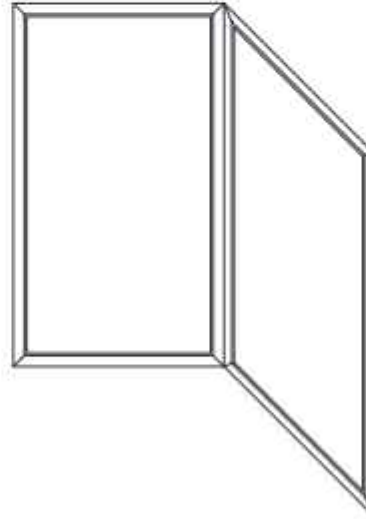
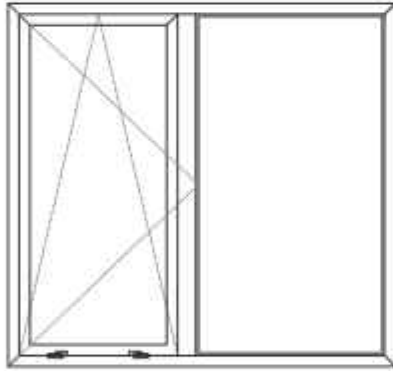
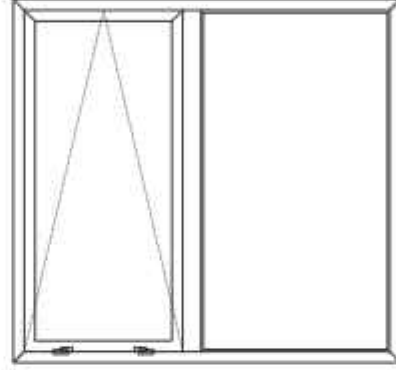
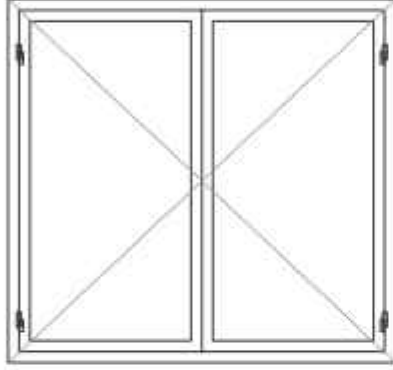

DETAY-1a

ÖLÇEK:1/1

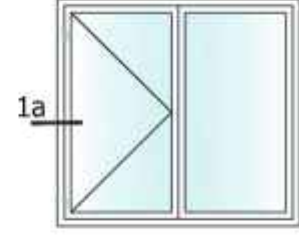

★ Yandaki profil birim ağırlıkları, bilgisayarla hesaplanmış teorik ağırlıklardır.

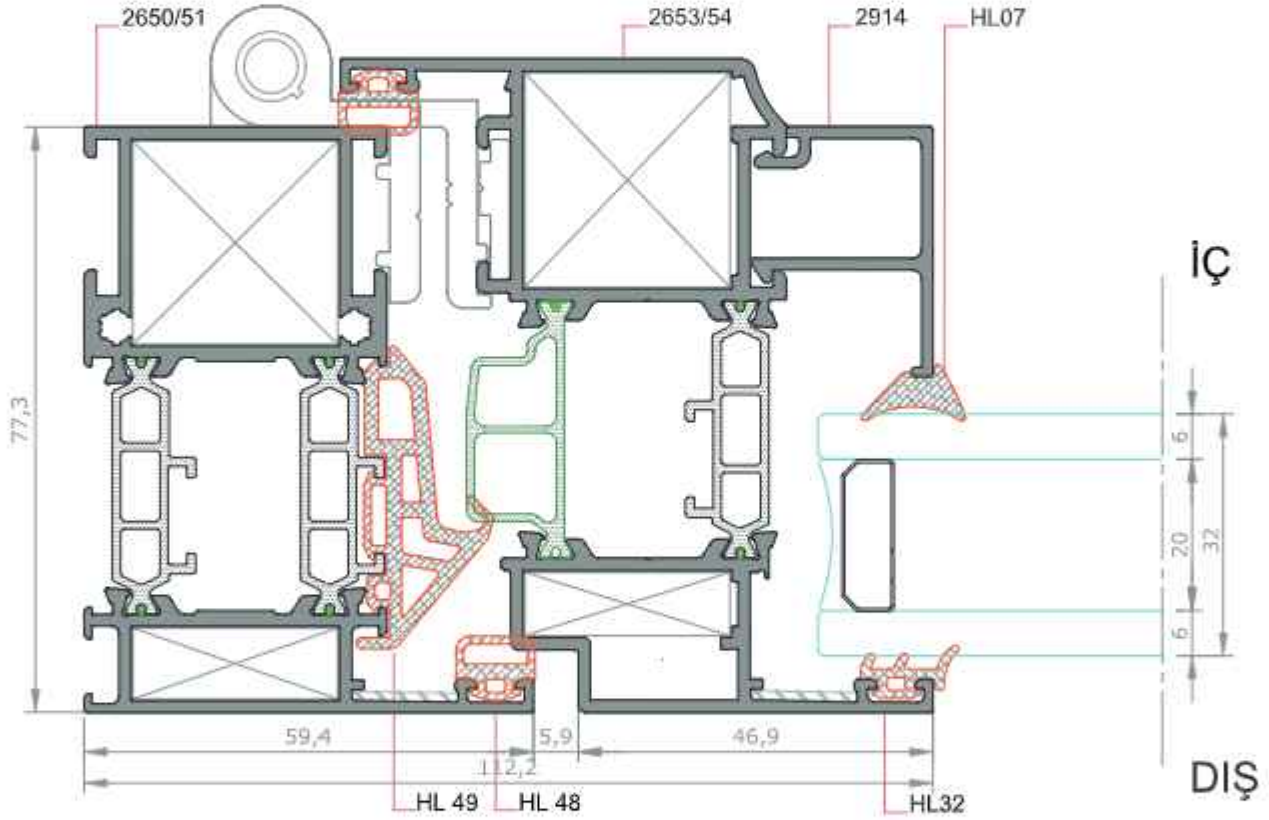

DETAY-1b
ÖLÇEK:1/1

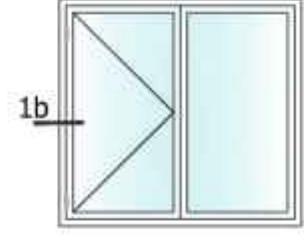

★ Yandaki profil birim ağırlıkları, bilgisayarda hesaplanmış teorik ağırlıklardır.

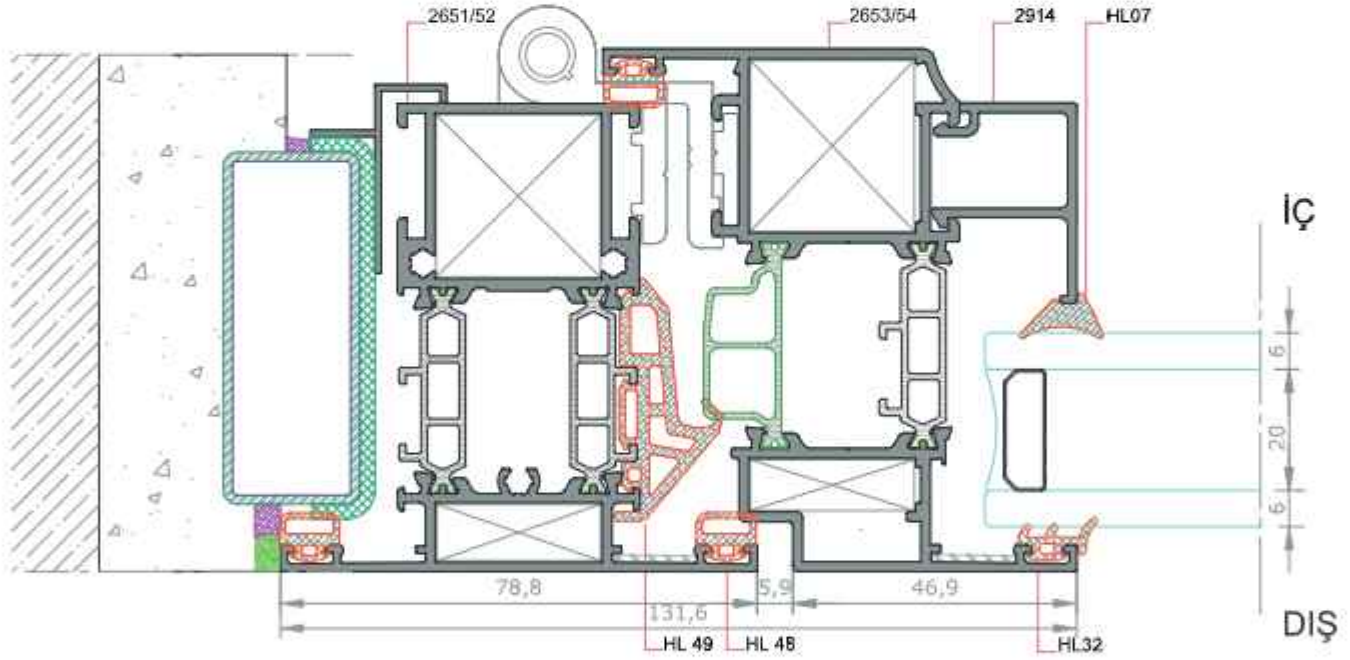

DETAY-1c

ÖLÇEK:1/1

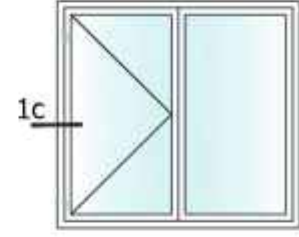

★ Yandaki profil birim ağırlıkları, bilgisayarla hesaplanmış teorik ağırlıklardır.

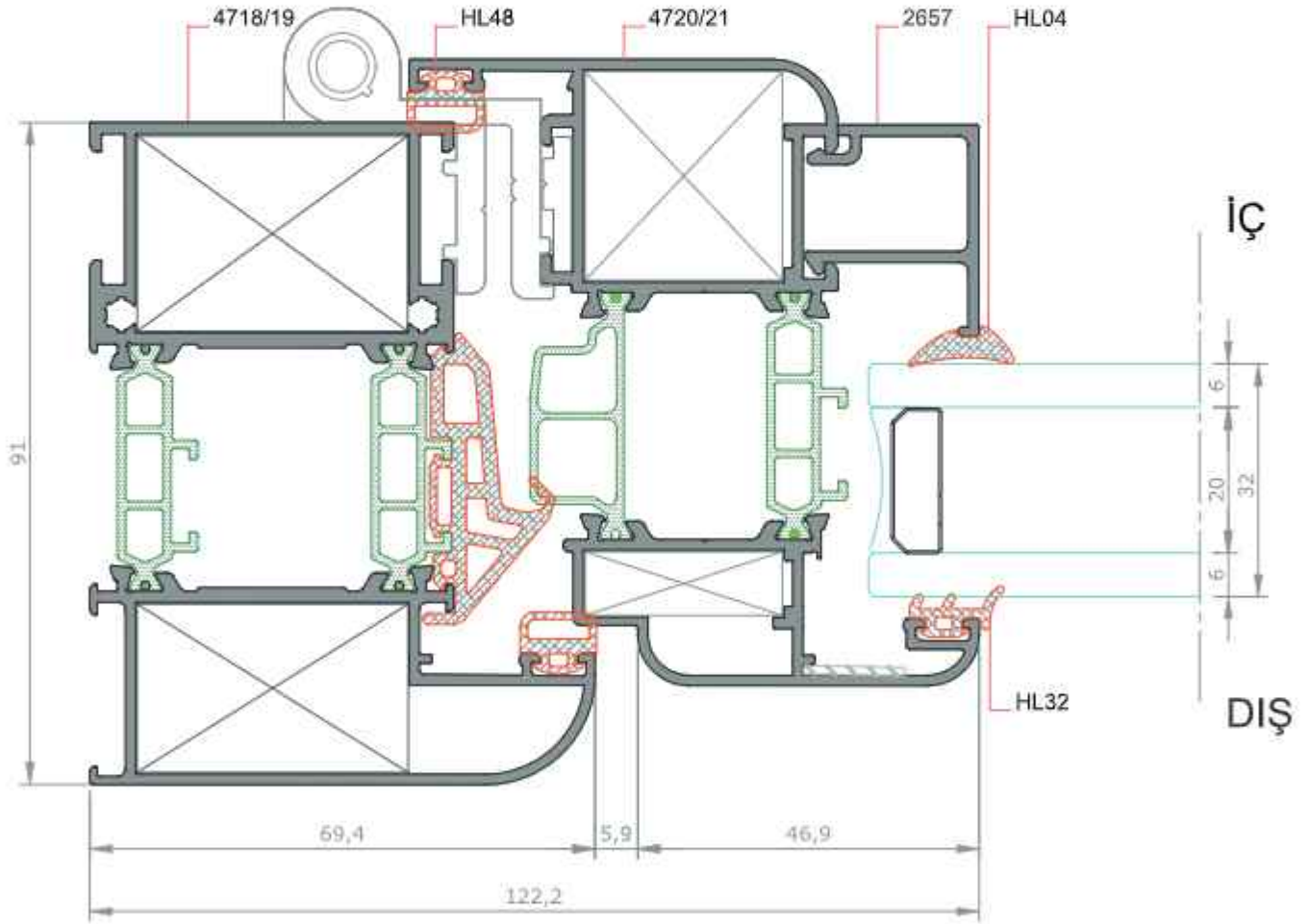

DETAY-1d
ÖLÇEK:ÖLÇEKSİZ

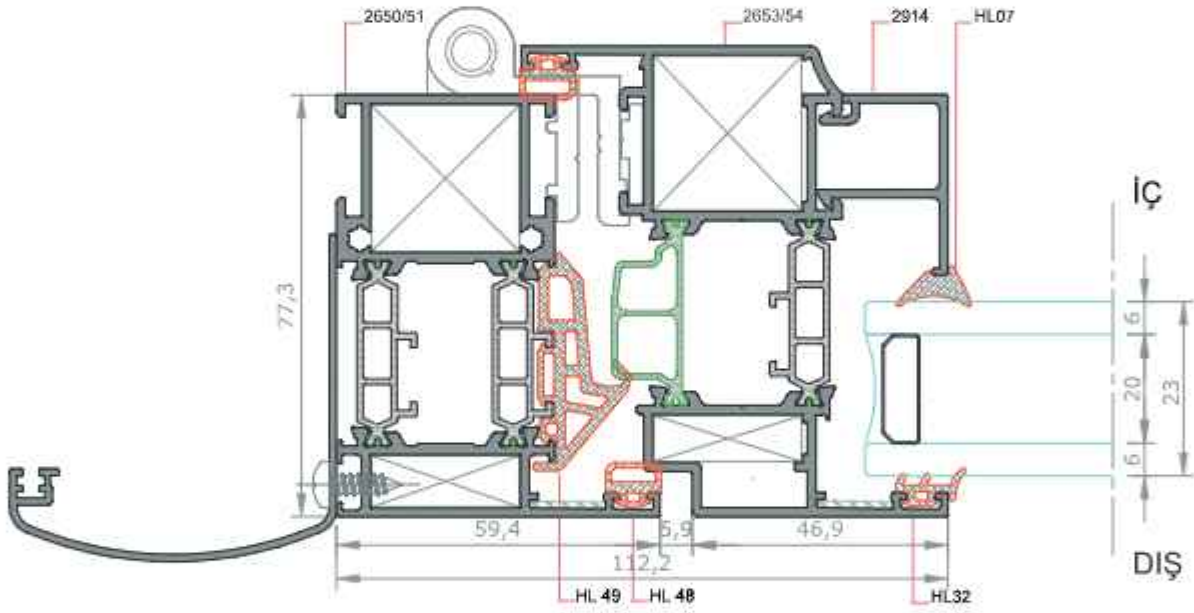
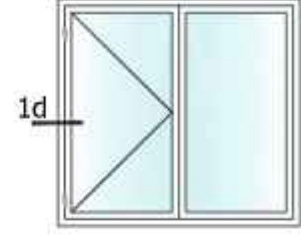

★ Yandaki profil birim ağırlıkları, bilgisayarda hesaplanmış teorik ağırlıklardır.

DETAY-2
ÖLÇEK:1/1

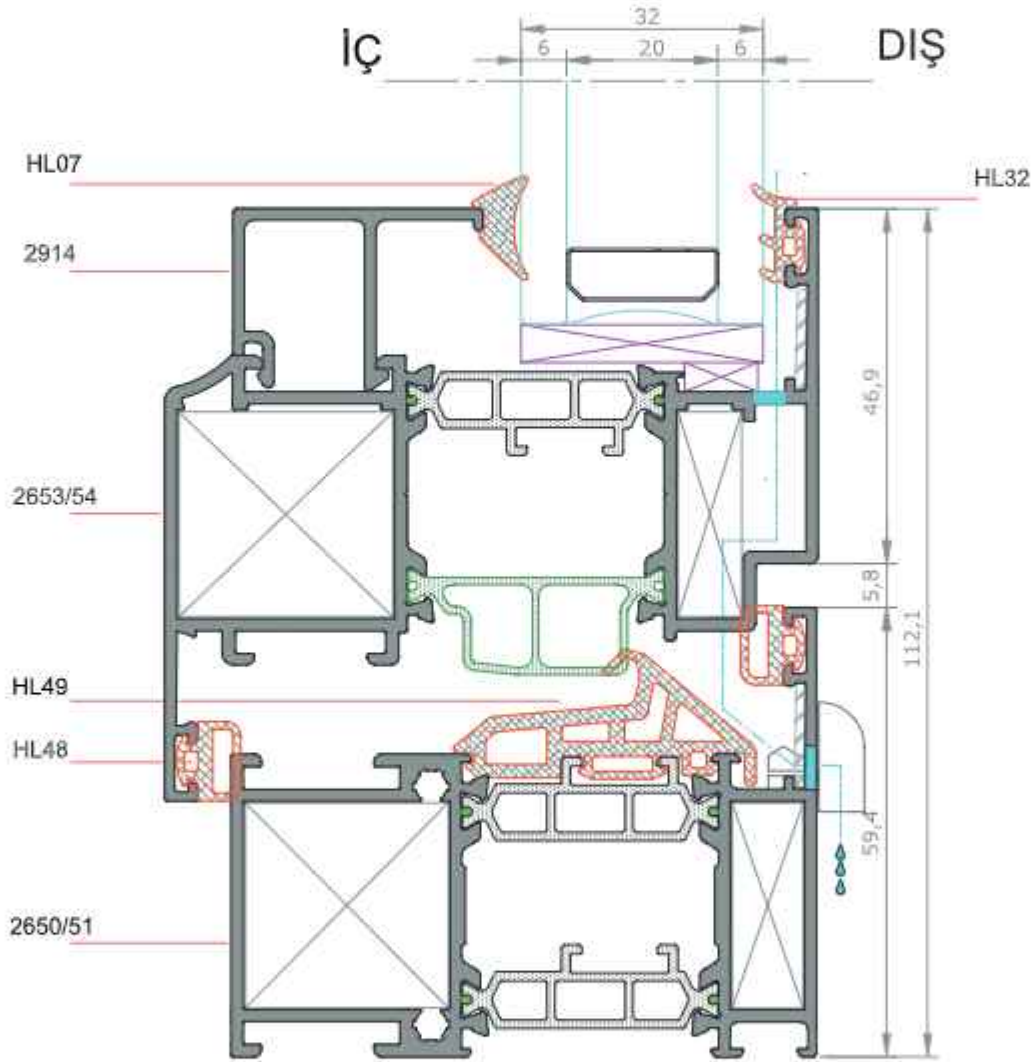
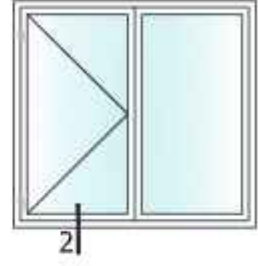

★ Yandaki profil birim ağırlıkları, bilgisayarla hesaplanmış teorik ağırlıklardır.

DETAY-3
ÖLÇEK:1/1

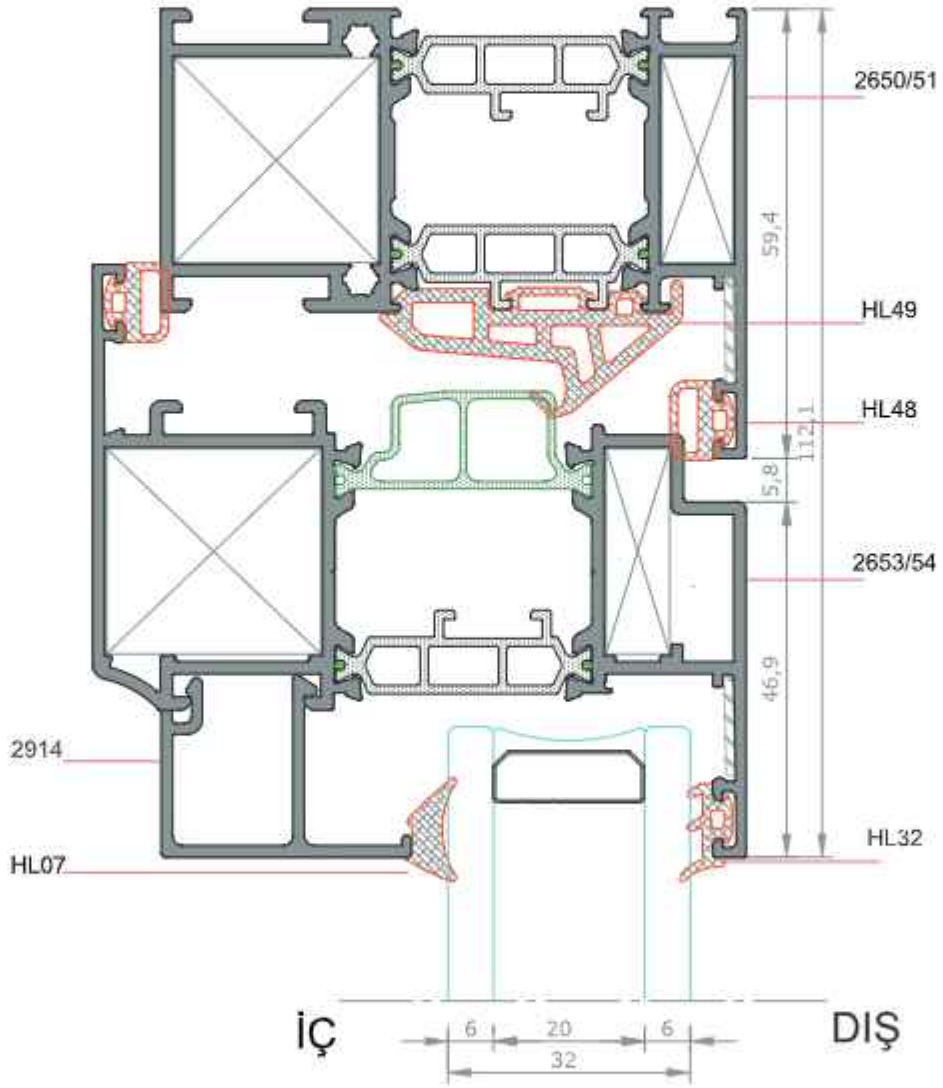
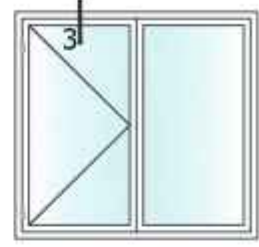

★ Yandaki profil birim ağırlıkları, bilgisayarla hesaplanmış teorik ağırlıklardır.

DETAY- 4

ÖLÇEK:1/1

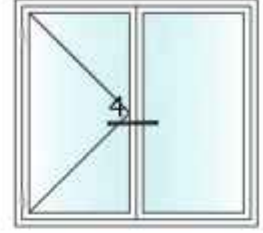

★ Yandaki profil birim ağırlıkları, bilgisayarla hesaplanmış teorik ağırlıklardır.

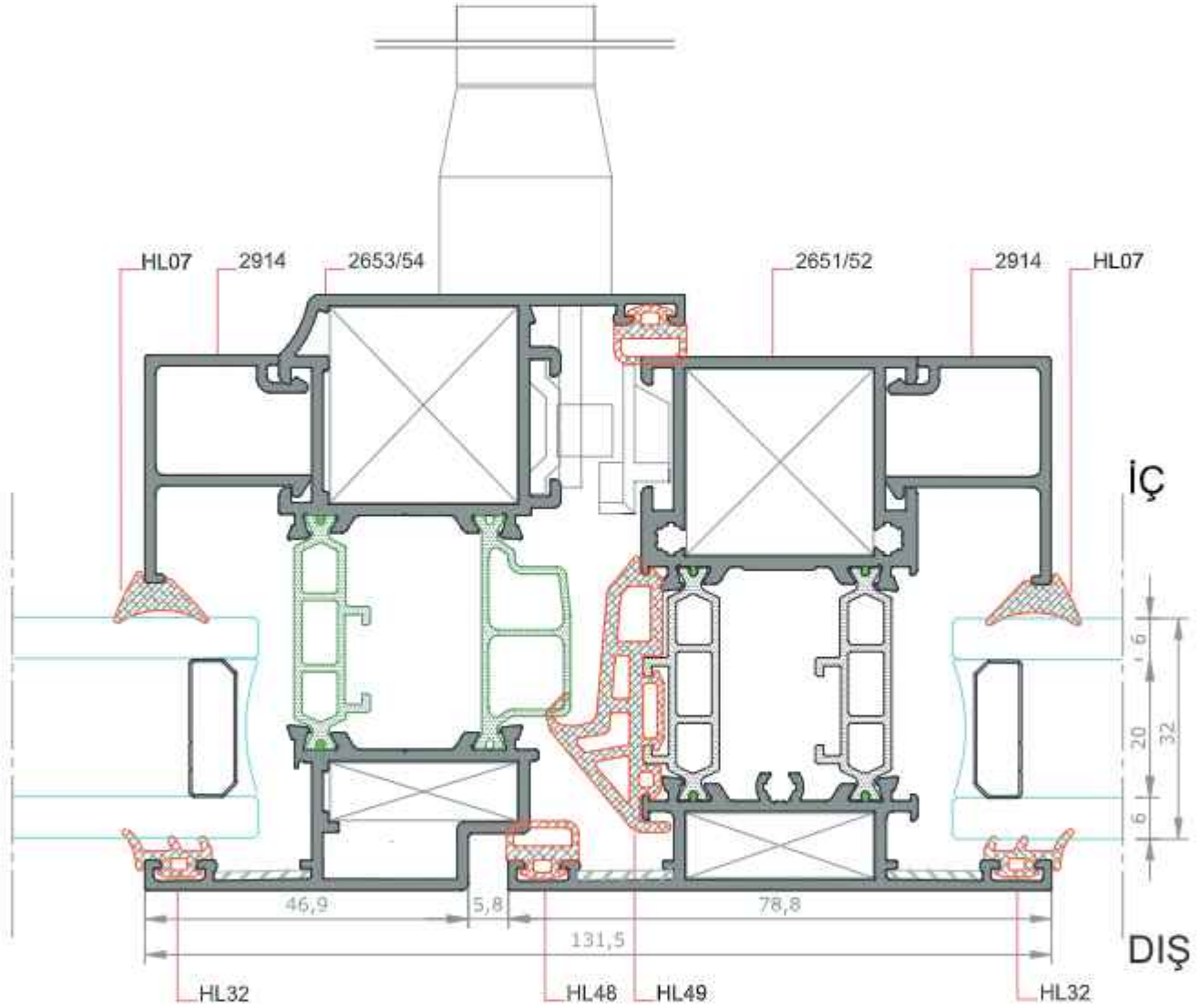

DETAY- 4a
ÖLÇEK:1/1

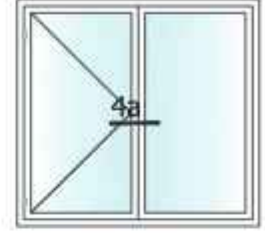

★ Yandaki profil birim ağırlıkları, bilgisayarda hesaplanmış teorik ağırlıklardır.

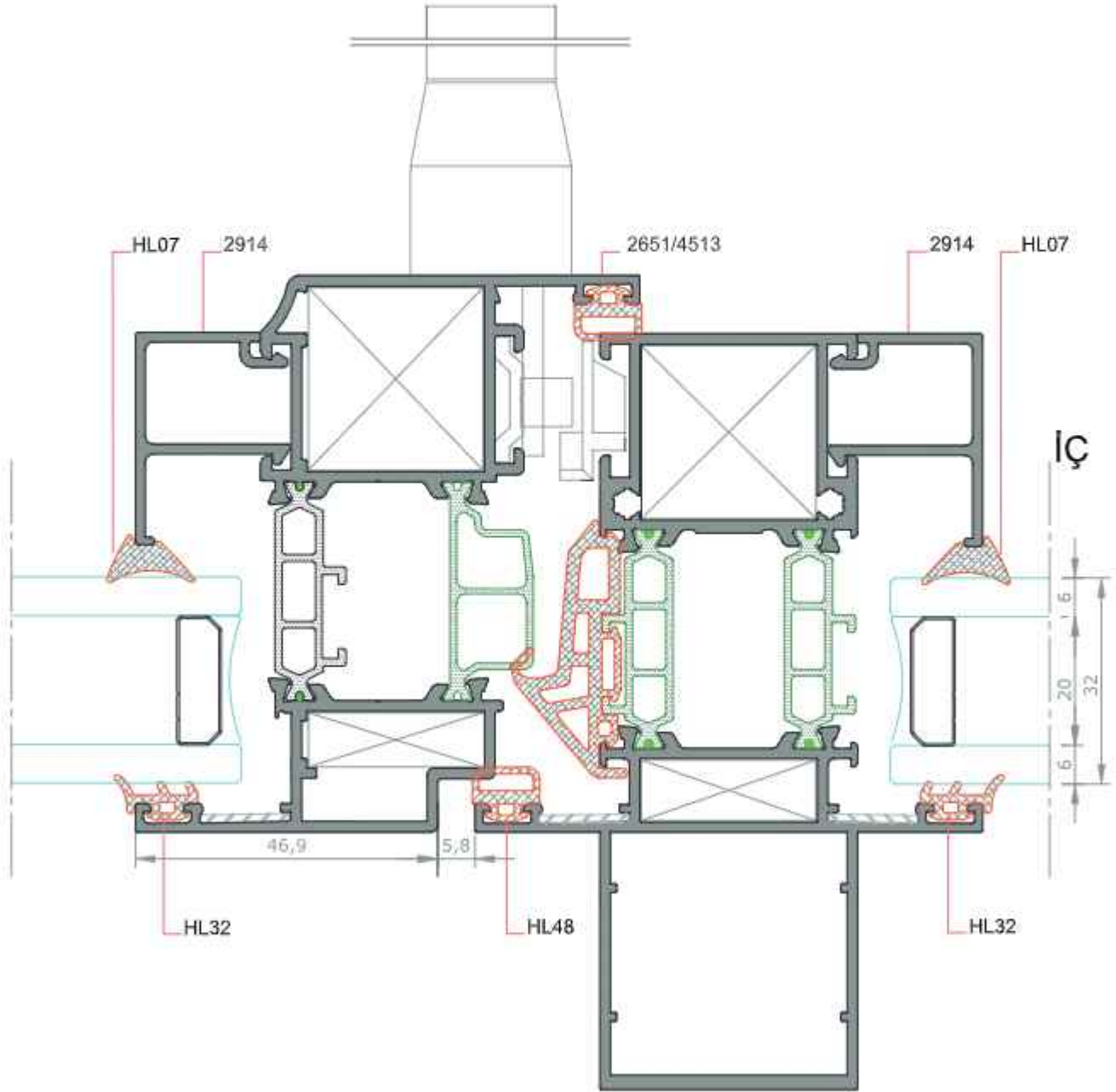

DETAY- 5
ÖLÇEK:1/1

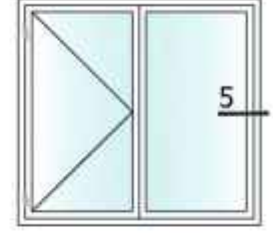

★ Yandaki profil birim ağırlıkları, bilgisayarla hesaplanmış teorik ağırlıklardır.

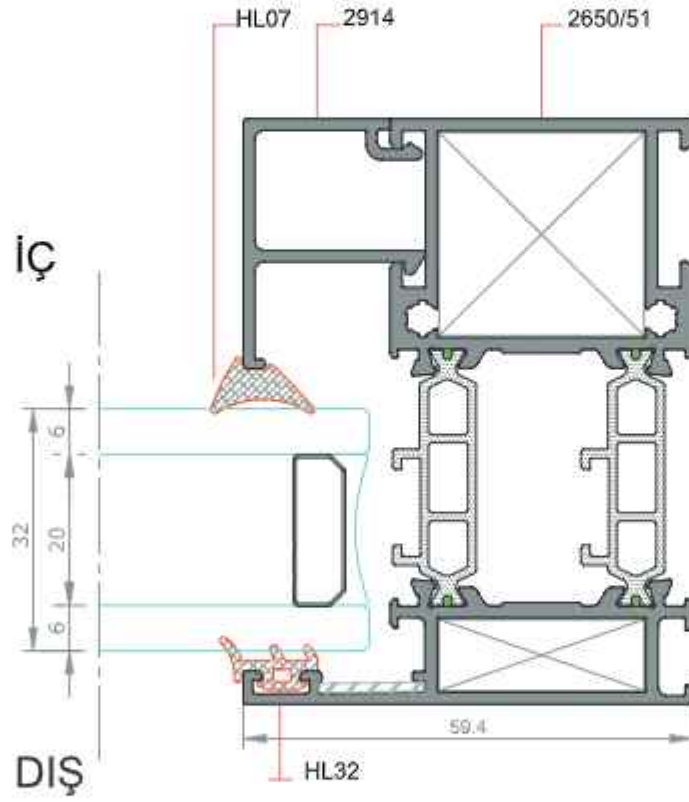

DETAY-1
ÖLÇEK:1/1

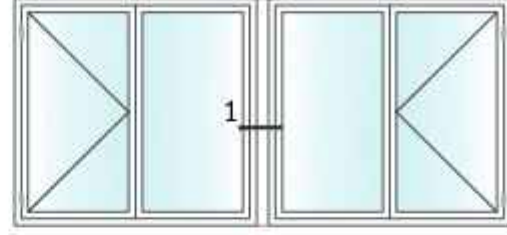

★ Yandaki profil birim ağırlıkları, bilgisayarda hesaplanmış teorik ağırlıklardır.

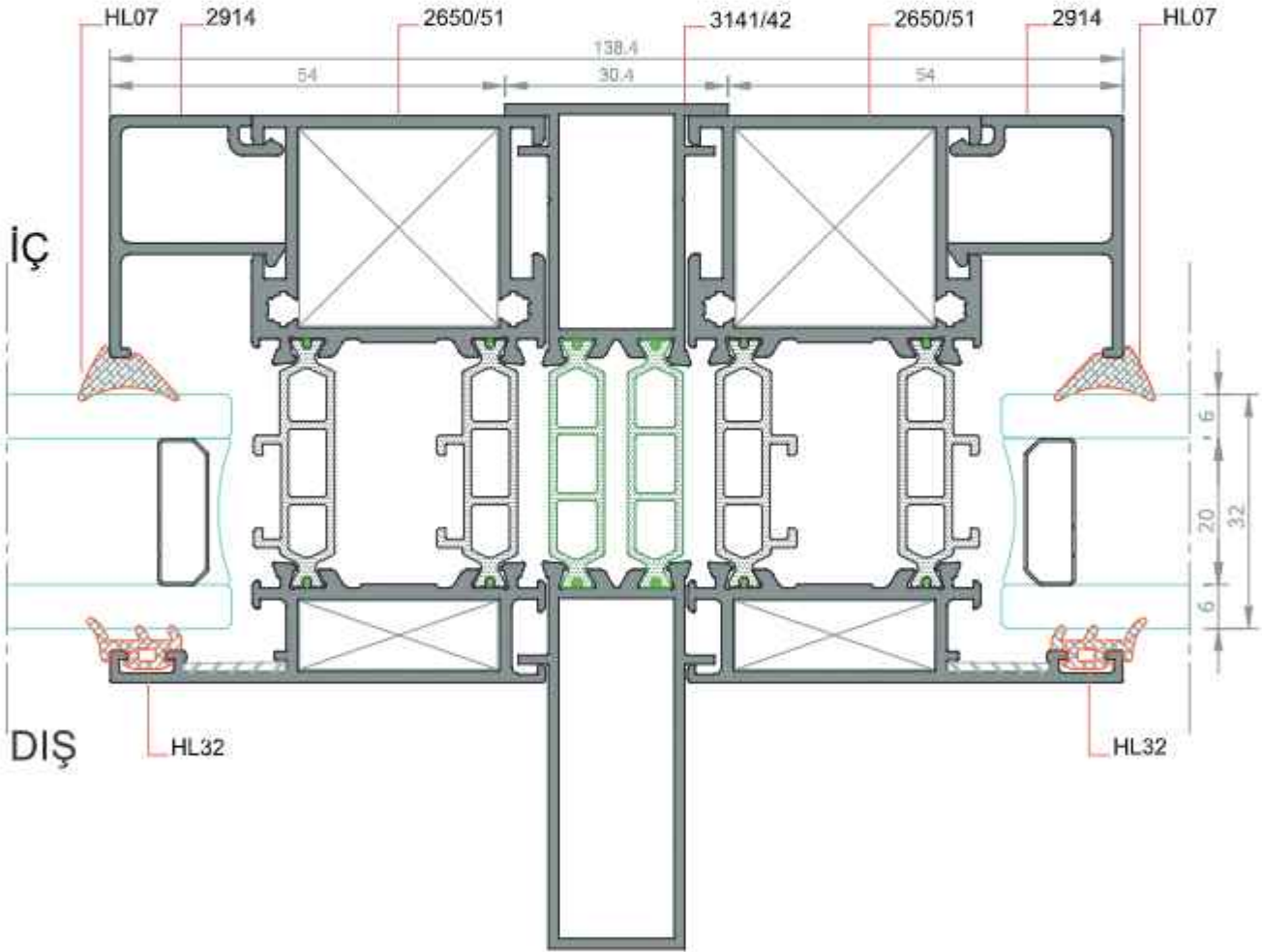

DETAY- 1a
ÖLÇEK:1/1

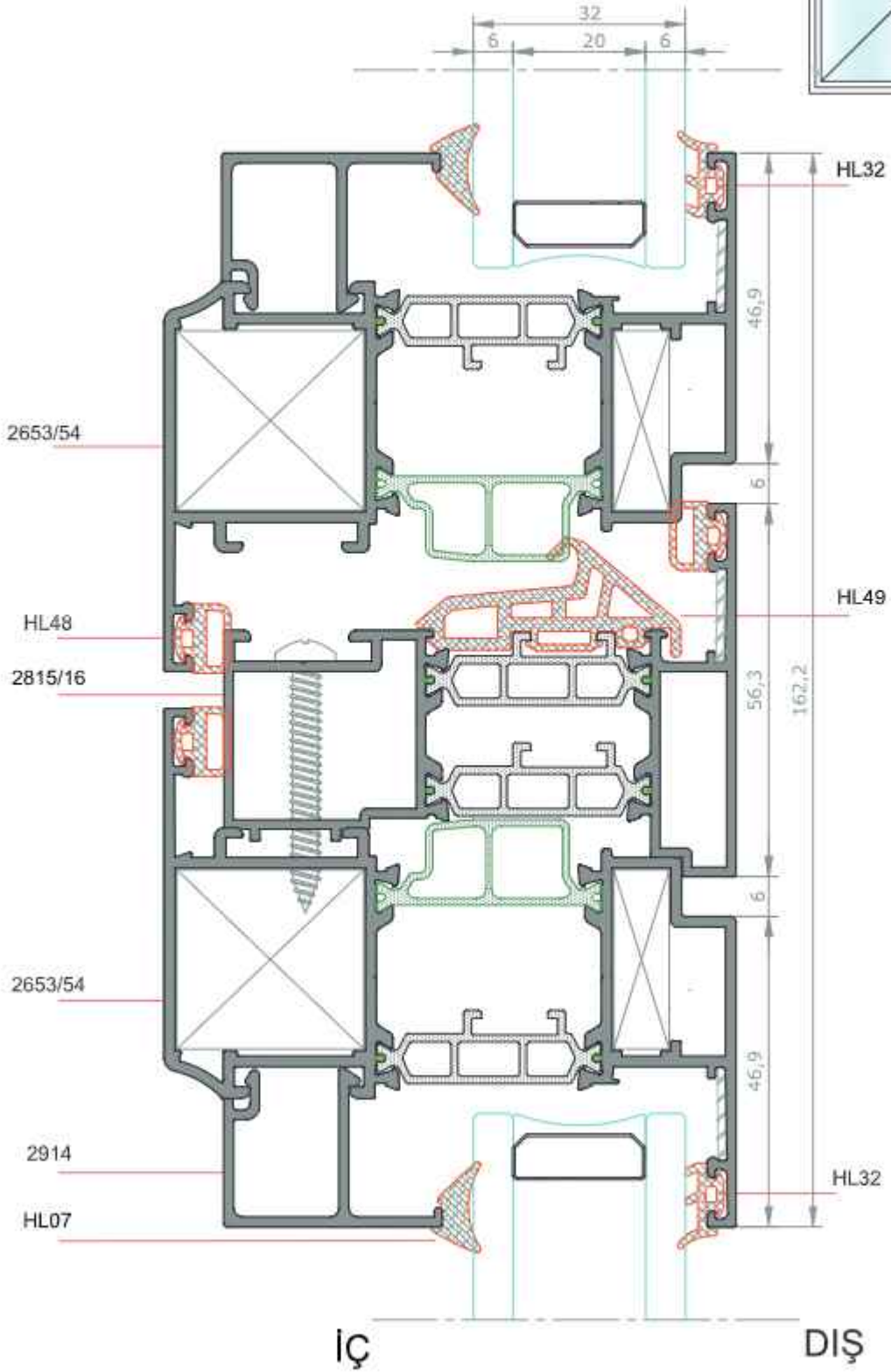
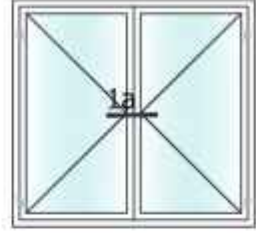

★ Yandaki profil birim ağırlıkları, bilgisayarla hesaplanmış teorik ağırlıklardır.

DETAY- 1b
ÖLÇEK:1/1

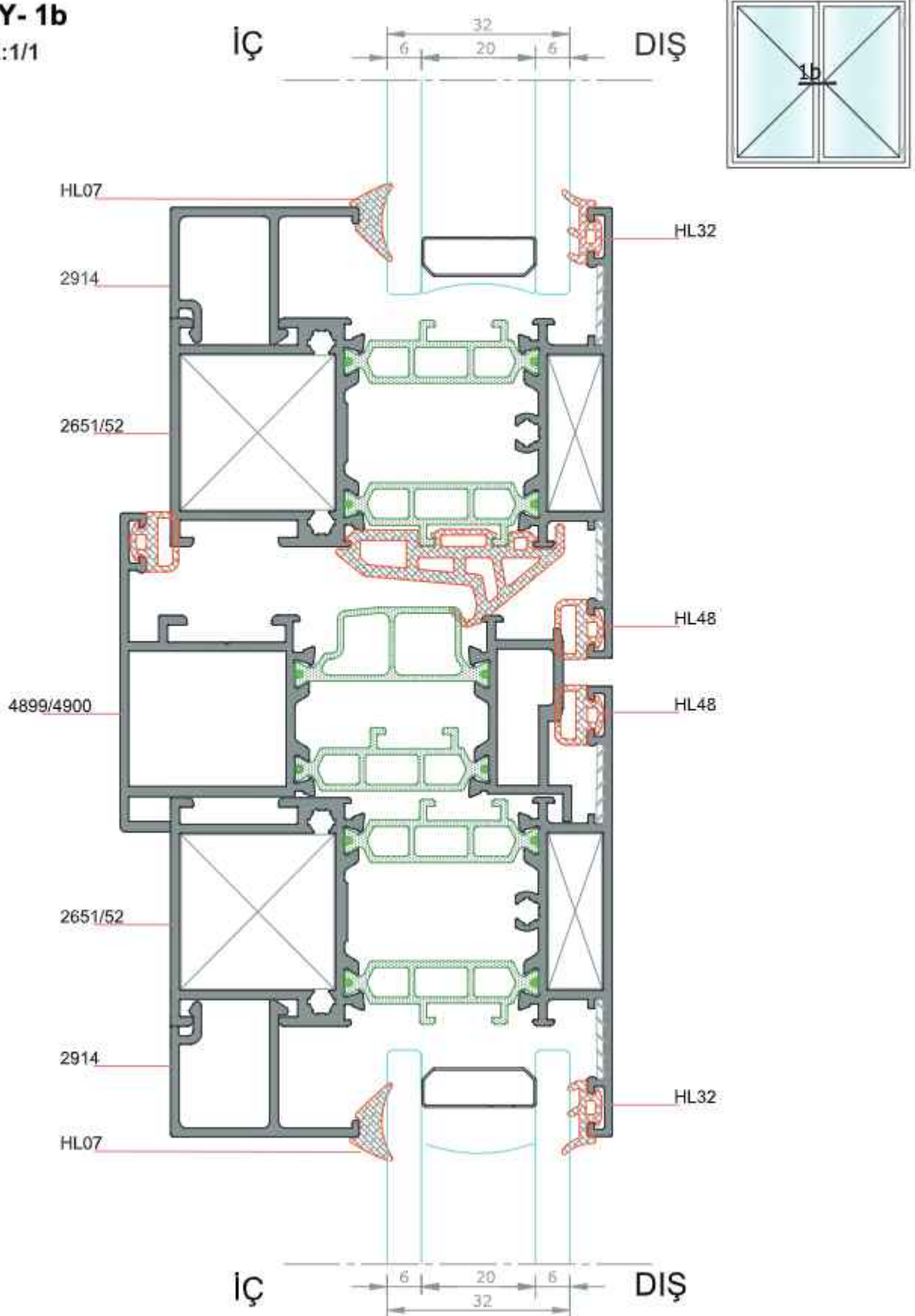

★ Yandaki profil birim ağırlıkları, bilgisayarla hesaplanmış teorik ağırlıklardır.

DETAY- 1c
ÖLÇEK:1/1

★ Yandaki profil birim ağırlıkları, bilgisayarla hesaplanmış teorik ağırlıklardır.

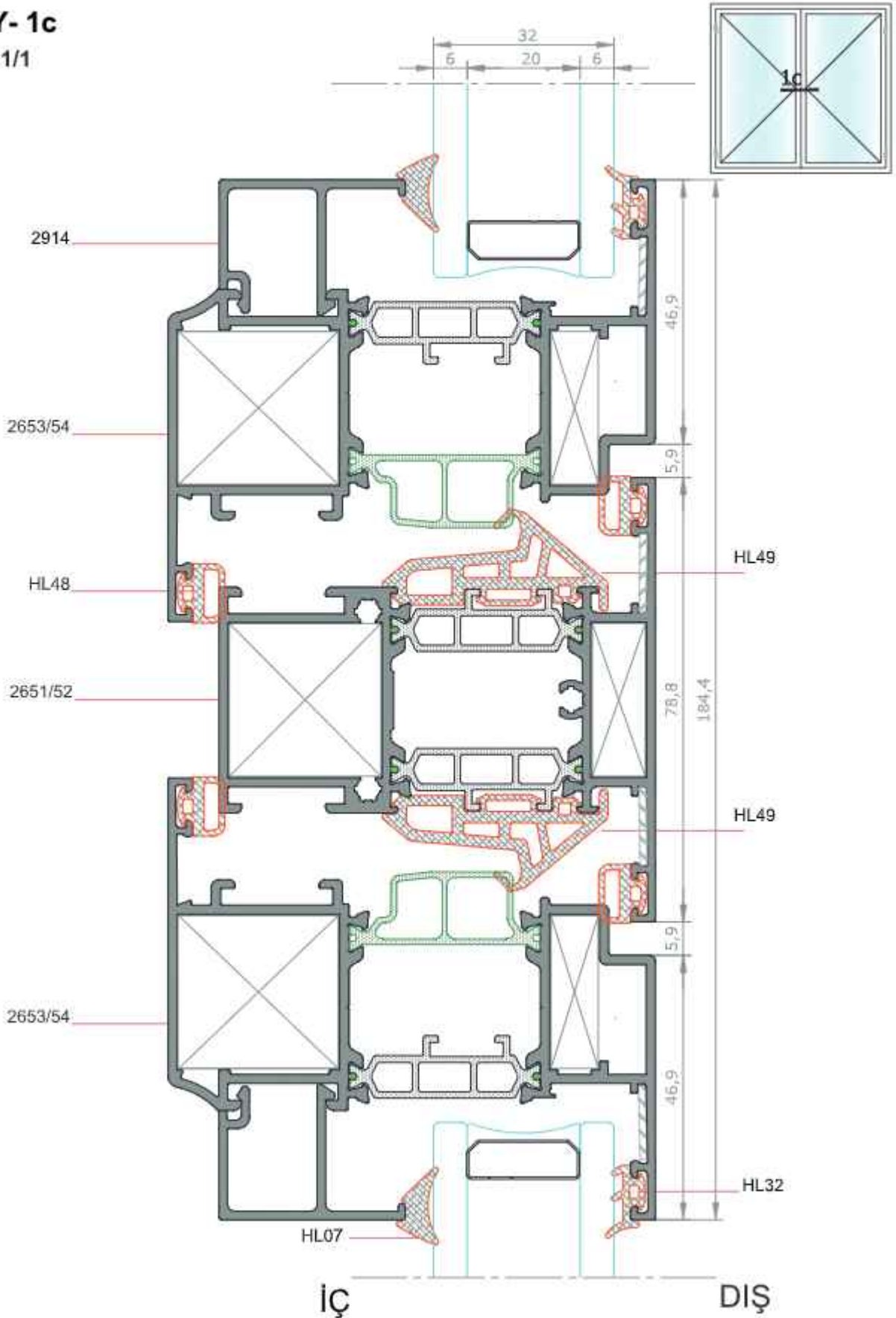

DETAY- 1
ÖLÇEK:1/1

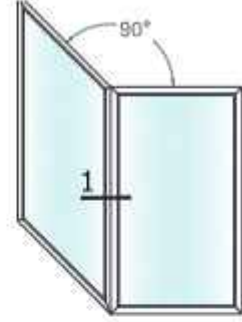

★ Yandaki profil birim ağırlıkları, bilgisayarda hesaplanmış teorik ağırlıklardır.

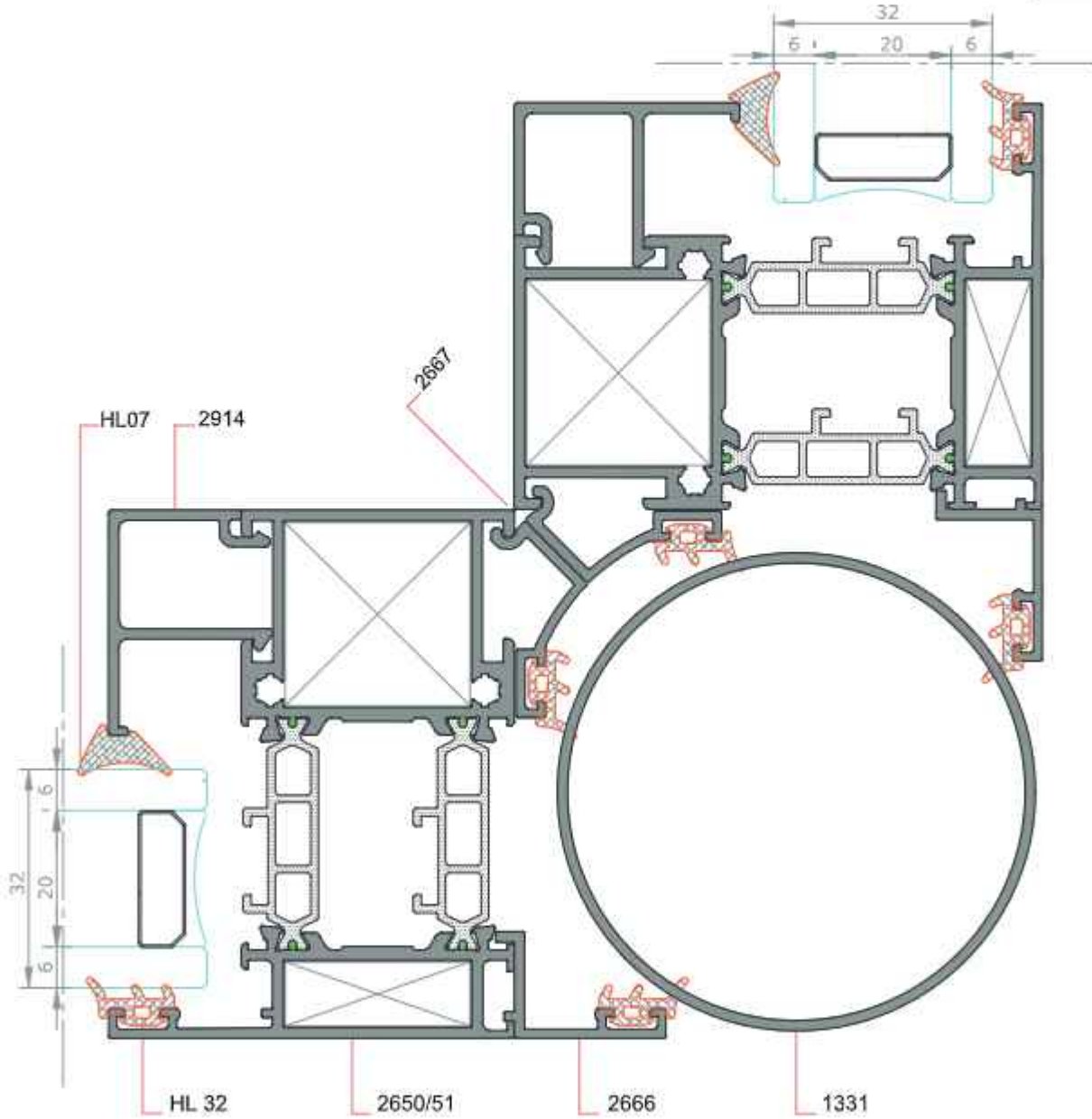

KAPI UYGULAMA TİPLERİ

★ Yandaki profil birim ağırlıkları, bilgisayarla hesaplanmış teorik ağırlıklardır.

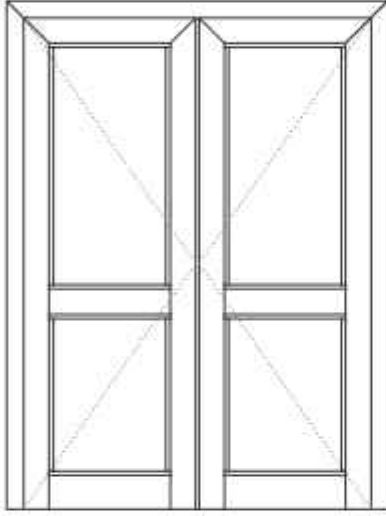

İçe Açılır Kapı

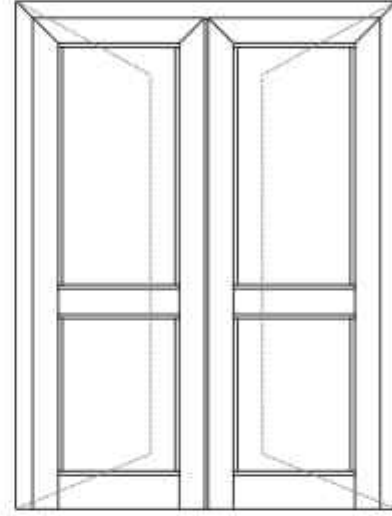

Dışa Açılır Kapı

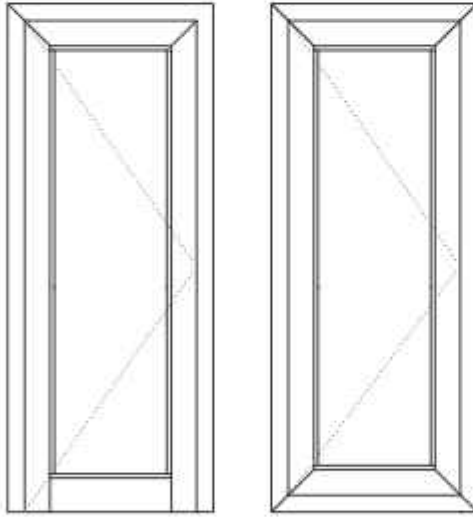

İçe Açılır Kapı

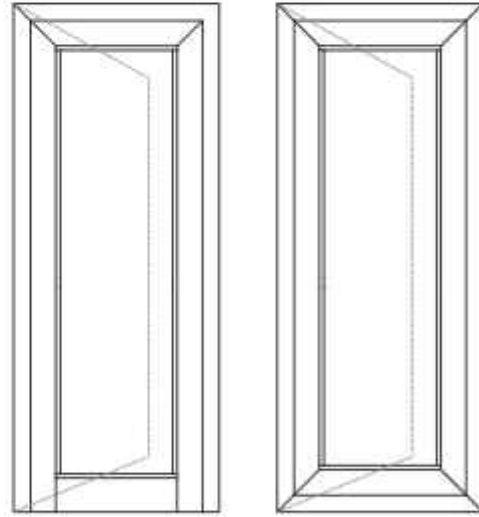

Dışa Açılır Kapı

DETAY- 1a
ÖLÇEK:1/1

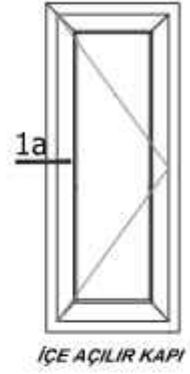

★ Yandaki profil birim ağırlıkları, bilgisayarda hesaplanmış teorik ağırlıklardır.

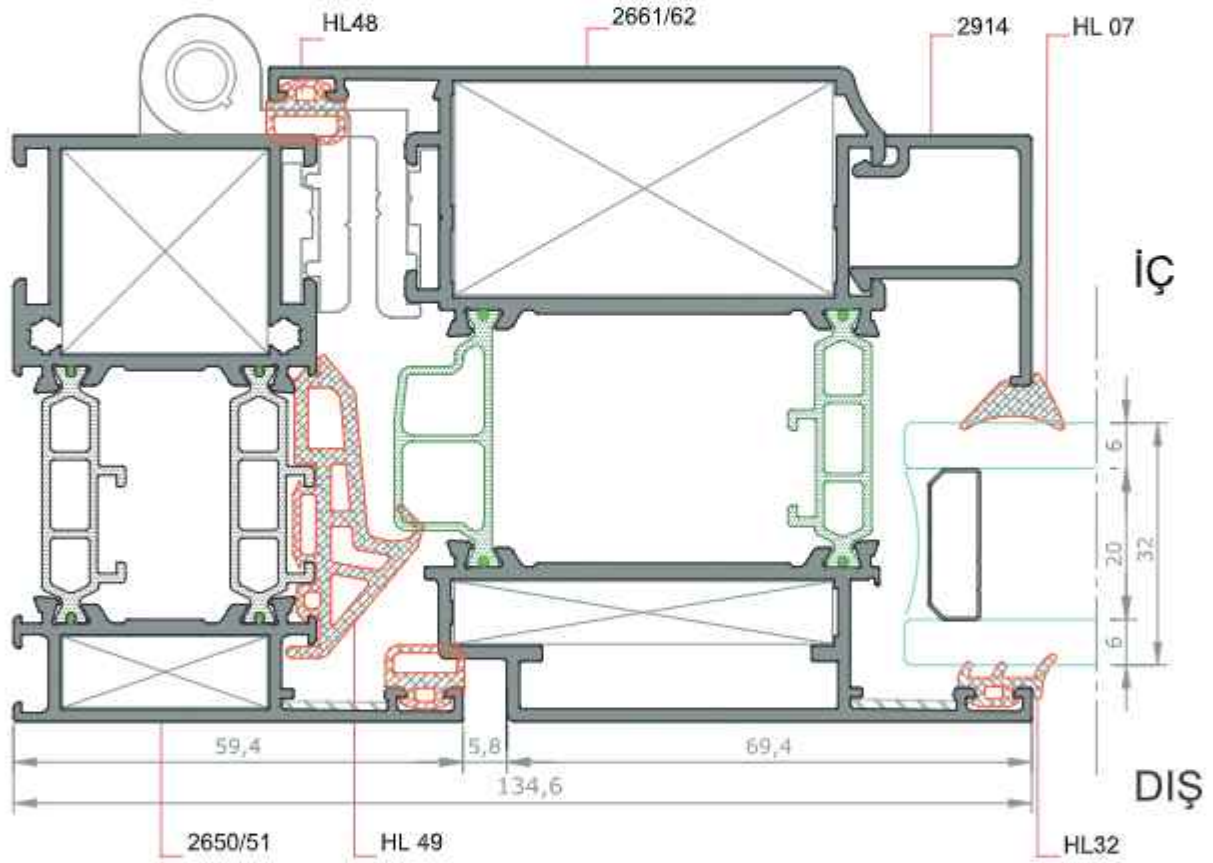

DETAY- 1b
ÖLÇEK:ÖLÇEKSİZ

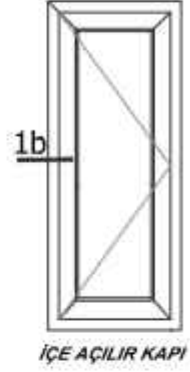

★ Yandaki profil birim ağırlıkları, bilgisayarda hesaplanmış teorik ağırlıklardır.

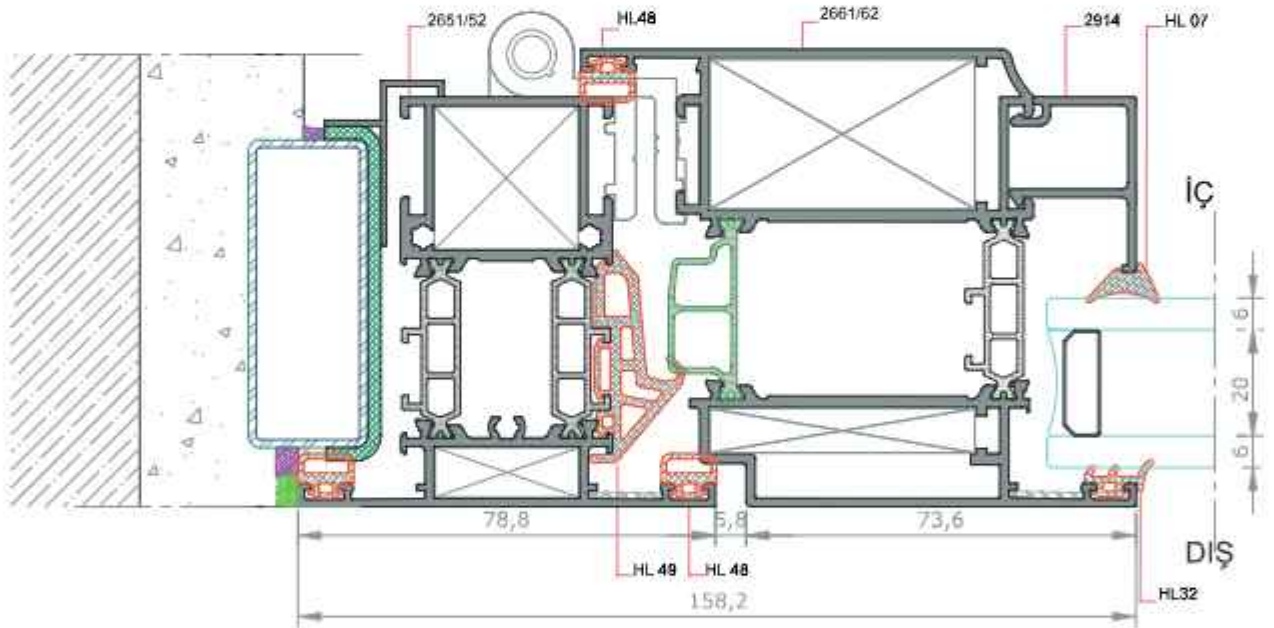

DETAY- 1c
ÖLÇEK:1/1

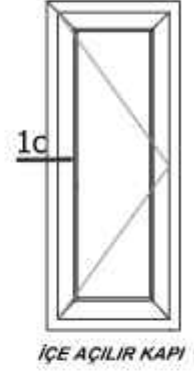

★ Yandaki profil birim ağırlıkları, bilgisayarda hesaplanmış teorik ağırlıklardır.

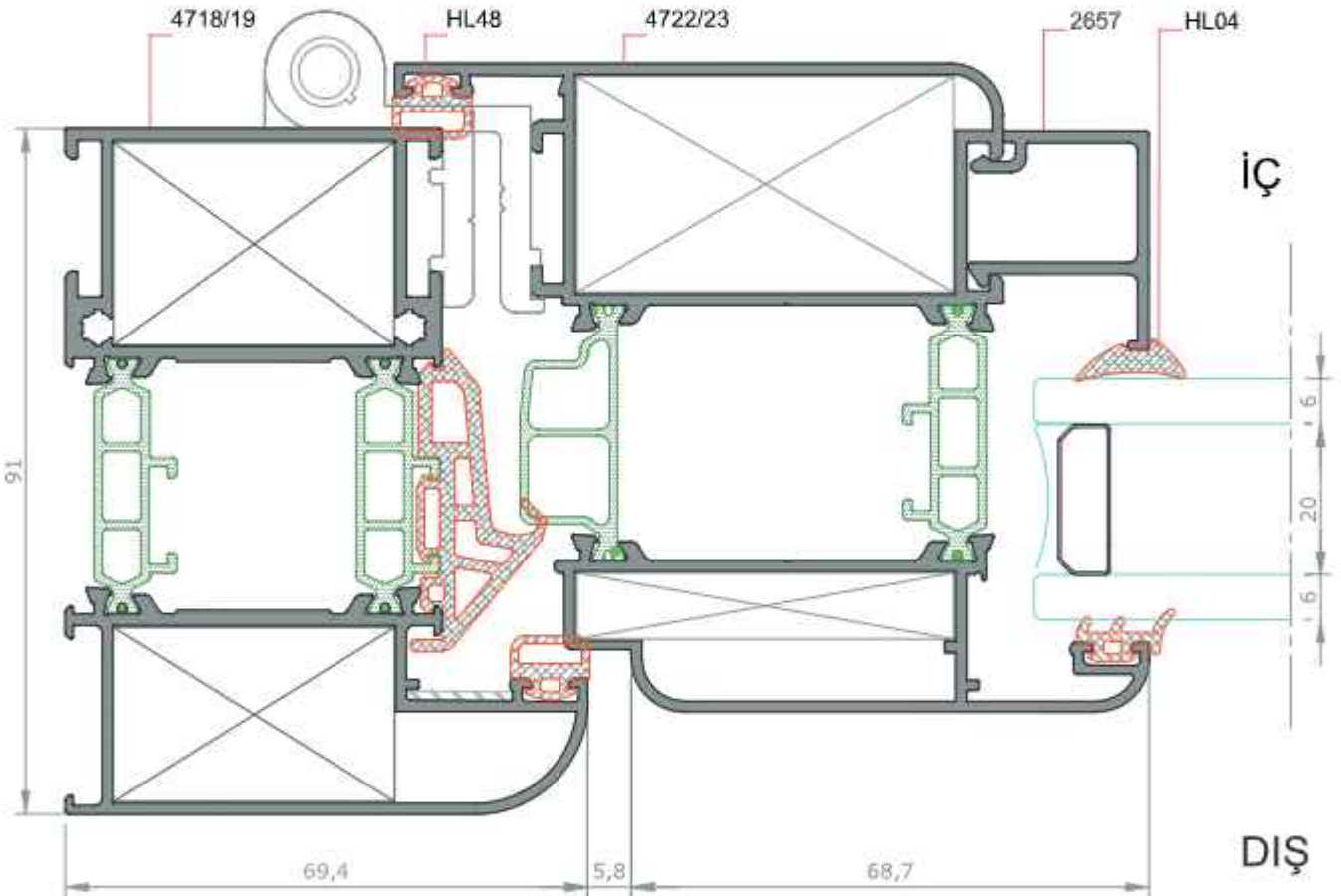

DETAY-2a
ÖLÇEK:1/1

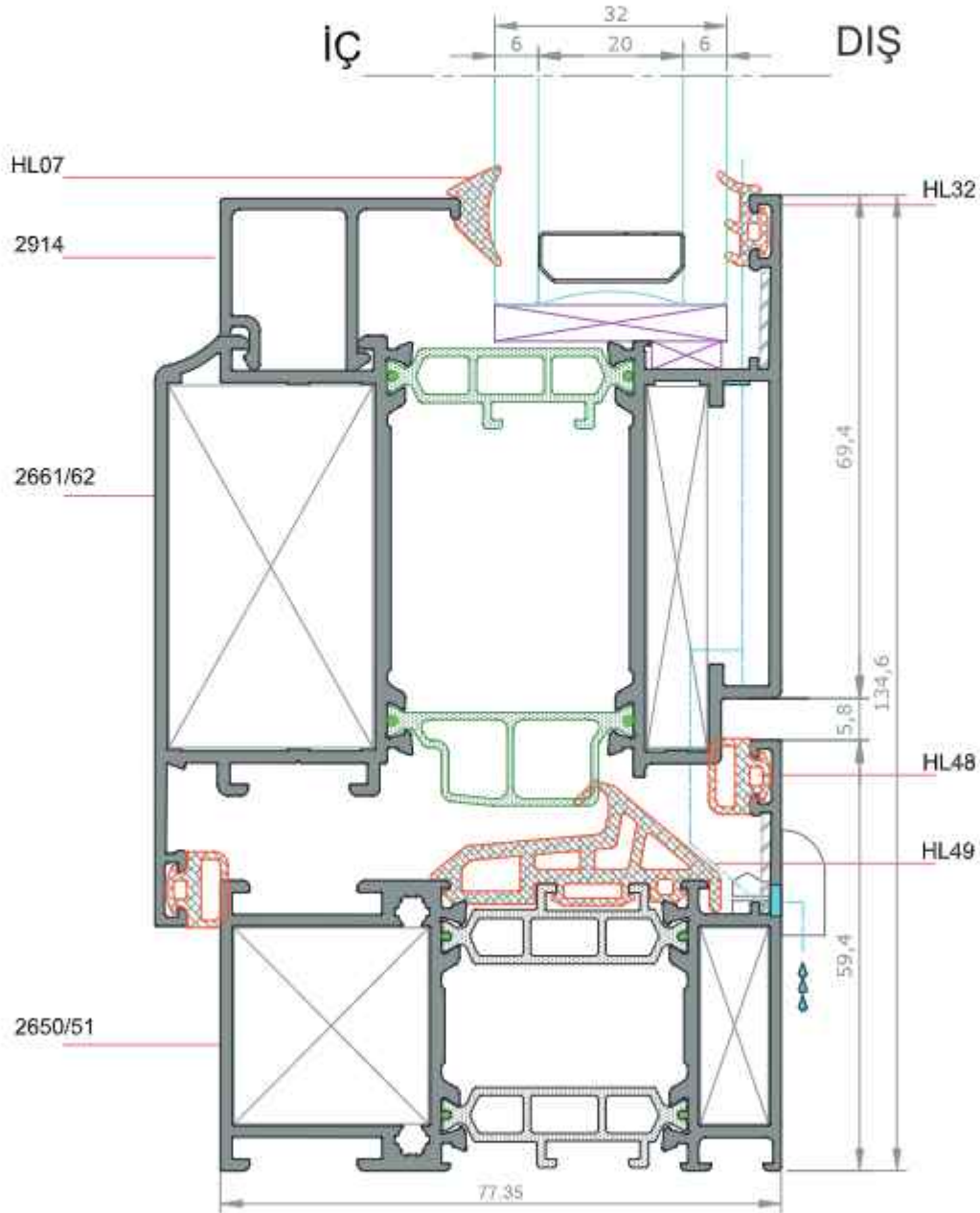
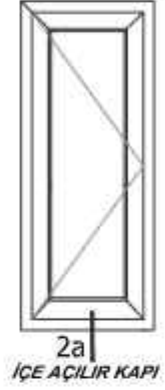

★ Yandaki profil birim ağırlıkları, bilgisayarla hesaplanmış teorik ağırlıklardır.

DETAY- 2b

ÖLÇEK:1/1

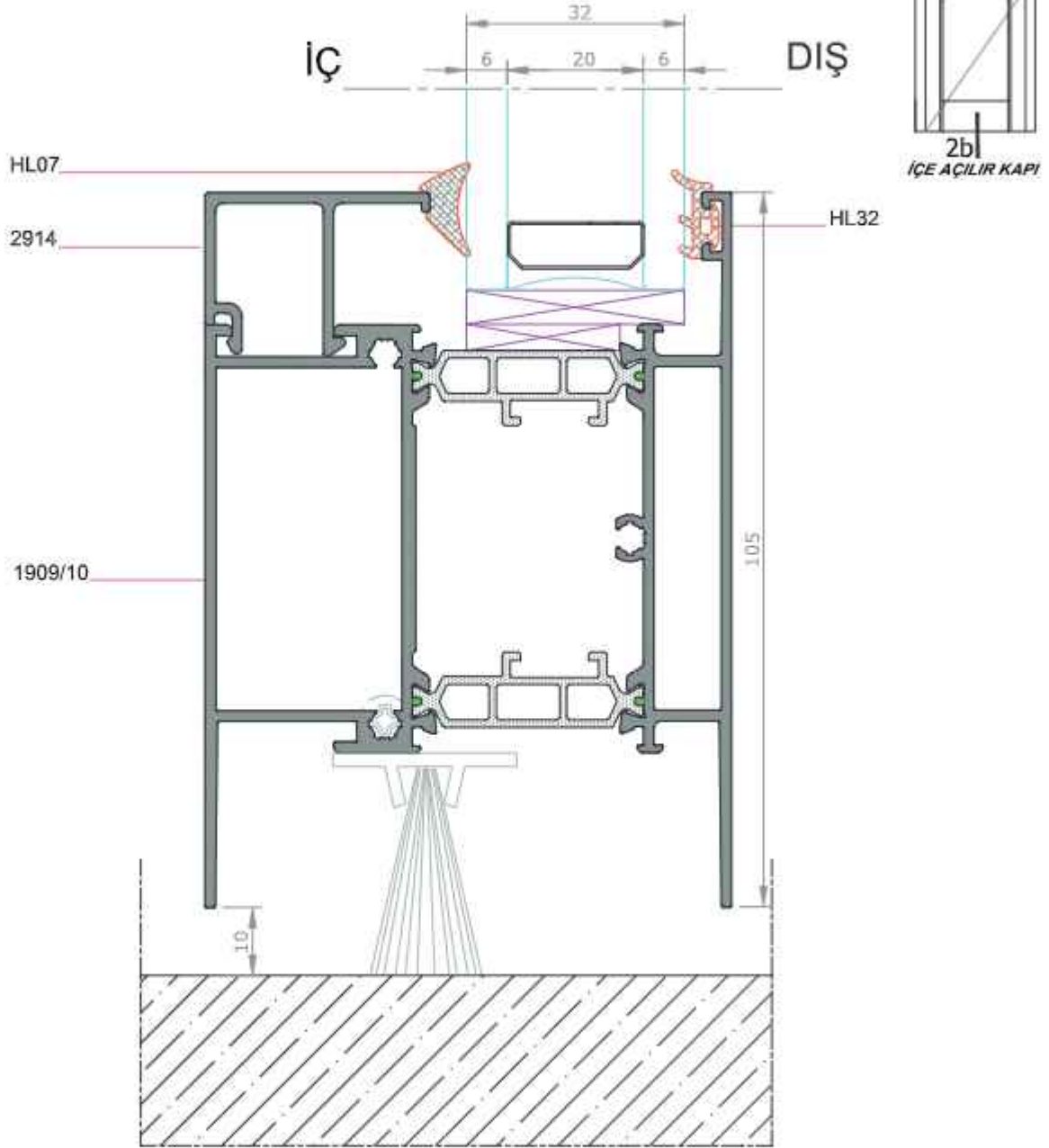

DETAY- 2c
ÖLÇEK:1/1

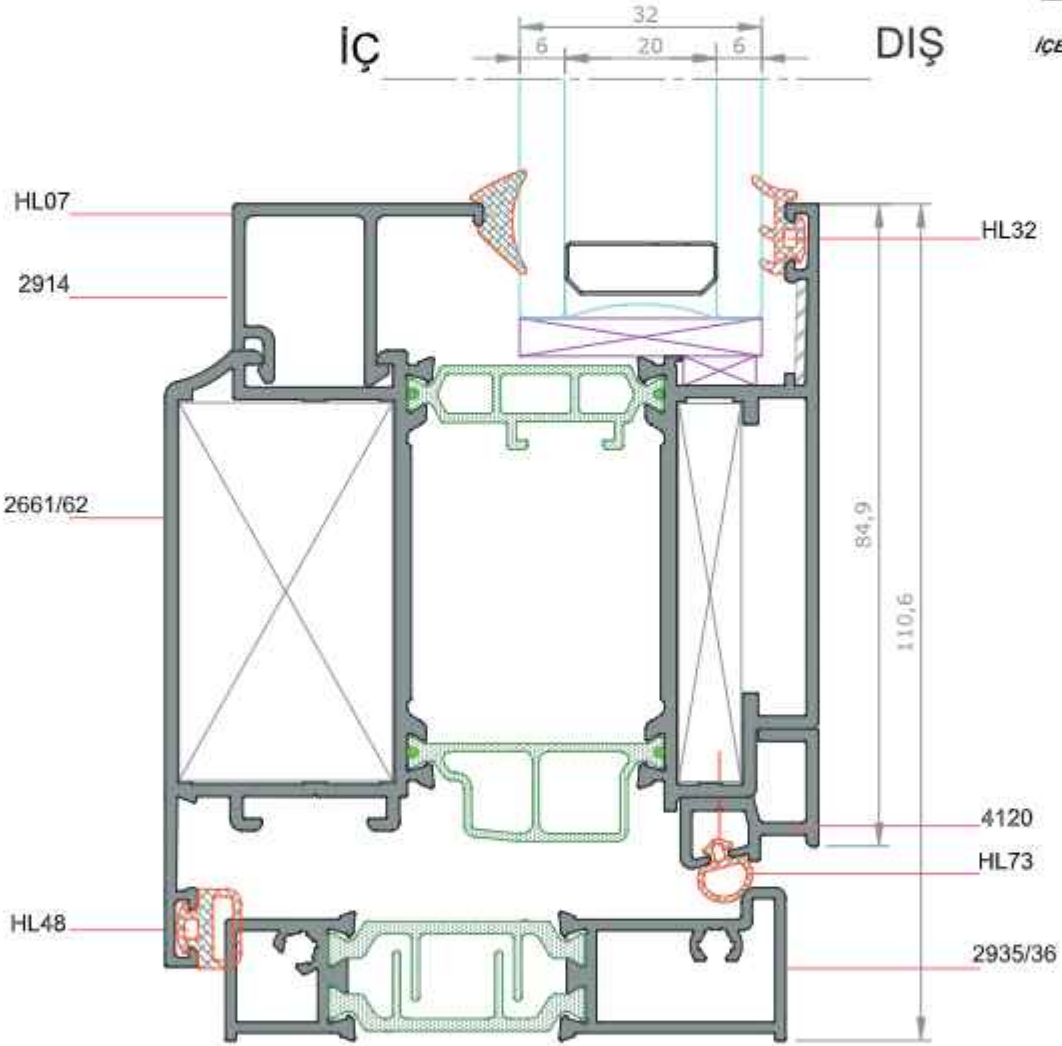

★ Yandaki profil birim ağırlıkları, bilgisayarla hesaplanmış teorik ağırlıklardır.

DETAY- 3
ÖLÇEK:1/1

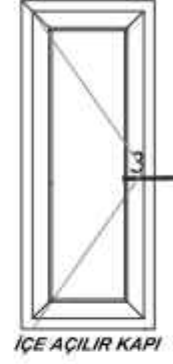

★ Yandaki profil birim ağırlıkları, bilgisayarda hesaplanmış teorik ağırlıklardır.

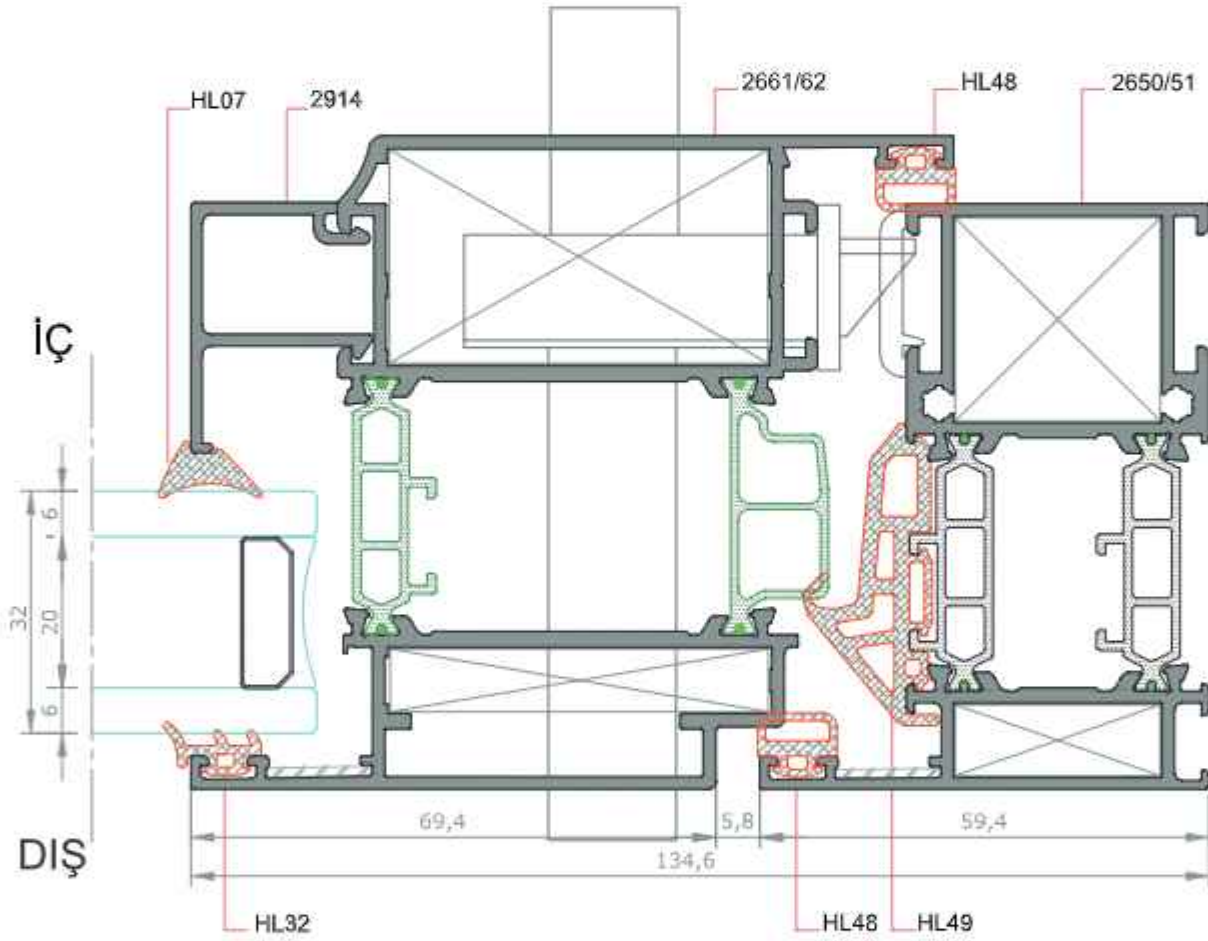

DETAY- 4
ÖLÇEK:1/1

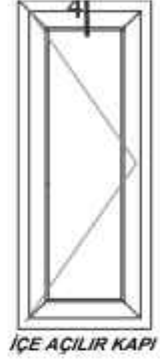

★ Yandaki profil birim ağırlıkları, bilgisayarla hesaplanmış teorik ağırlıklardır.

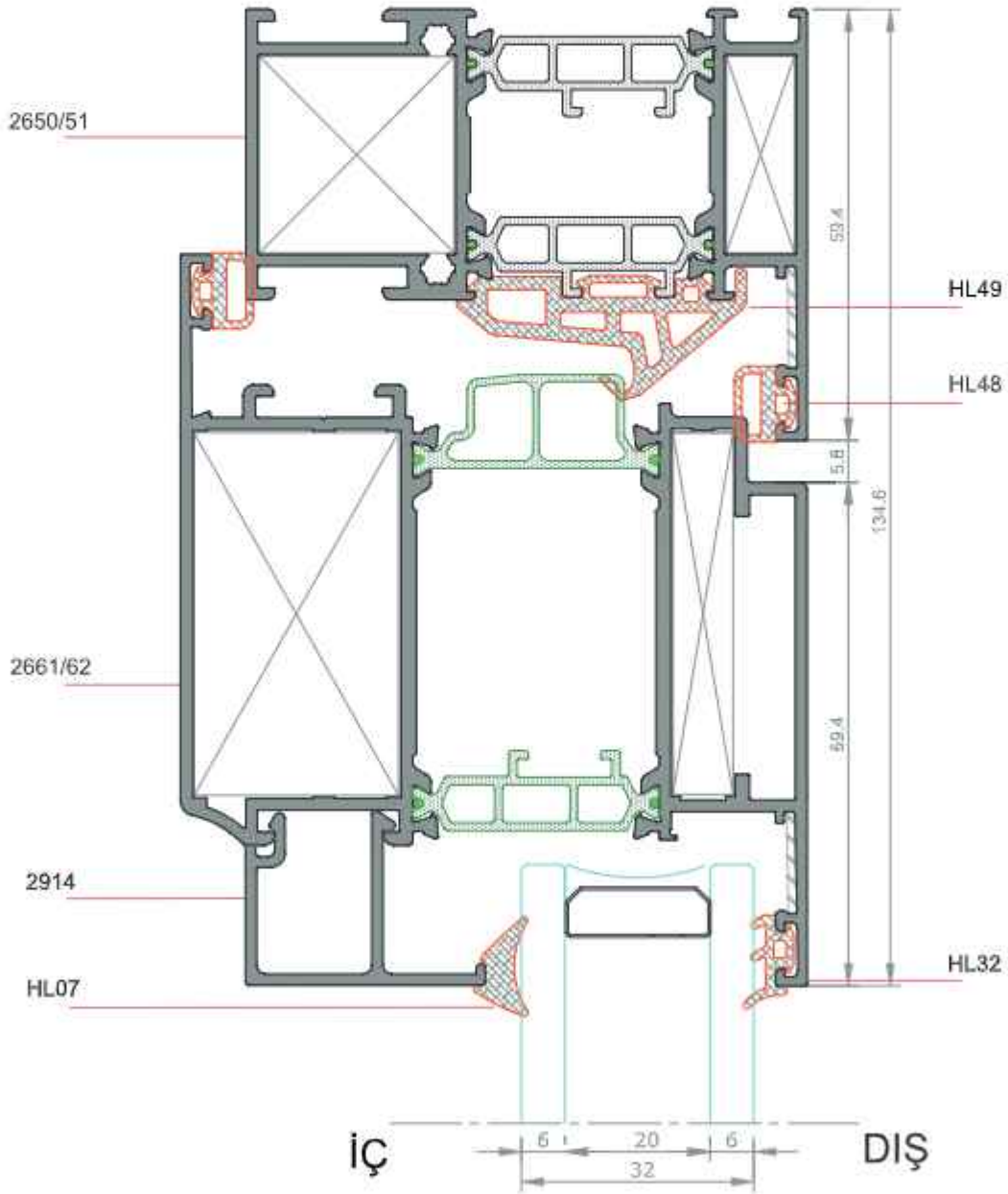

DETAY- 1
ÖLÇEK:1/1

★ Yandaki profil birim ağırlıkları, bilgisayarda hesaplanmış teorik ağırlıklardır.

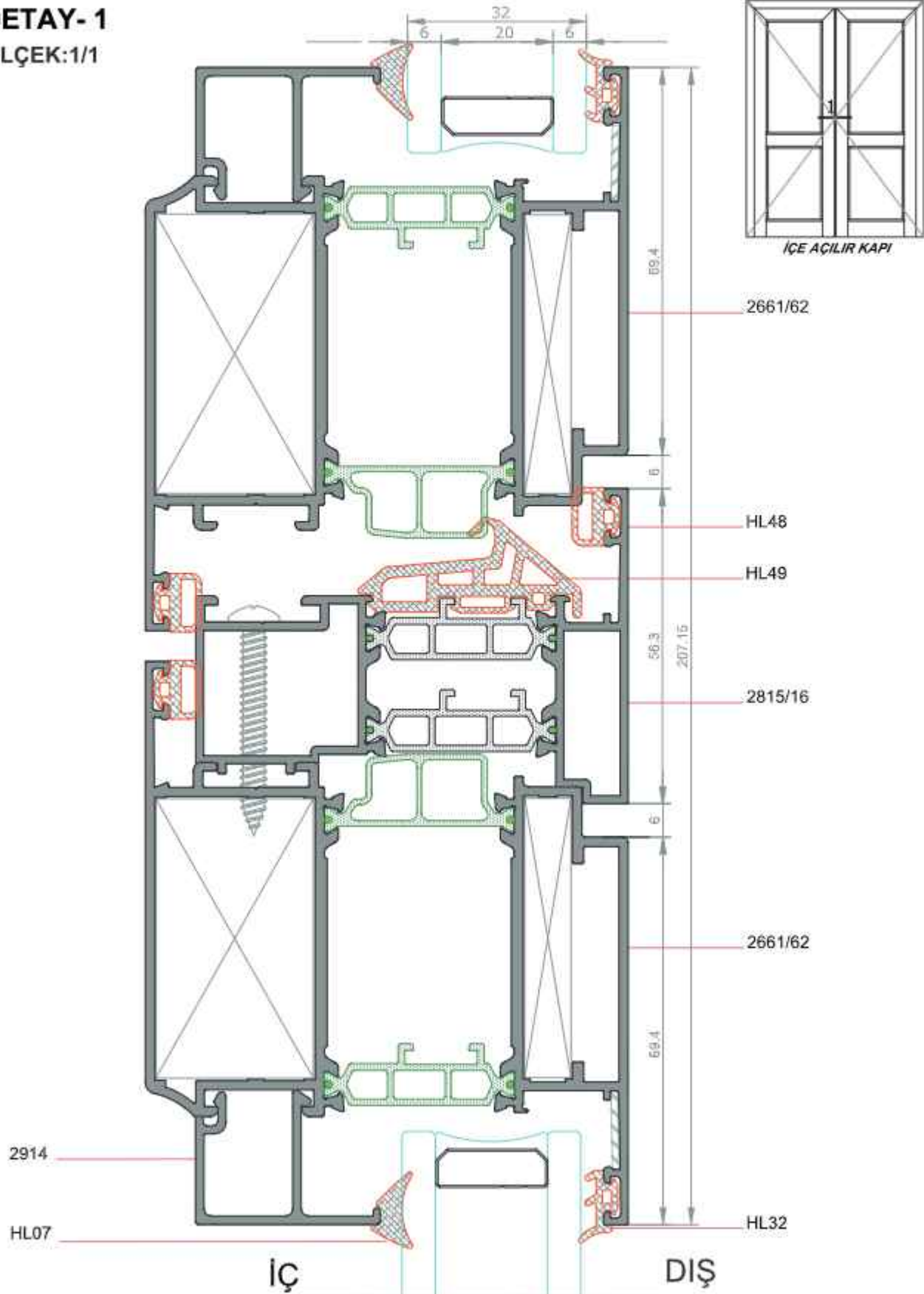

DETAY- 1
ÖLÇEK:1/1

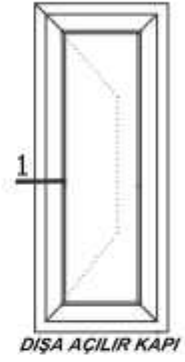

★ Yandaki profil birim ağırlıkları, bilgisayarla hesaplanmış teorik ağırlıklardır.

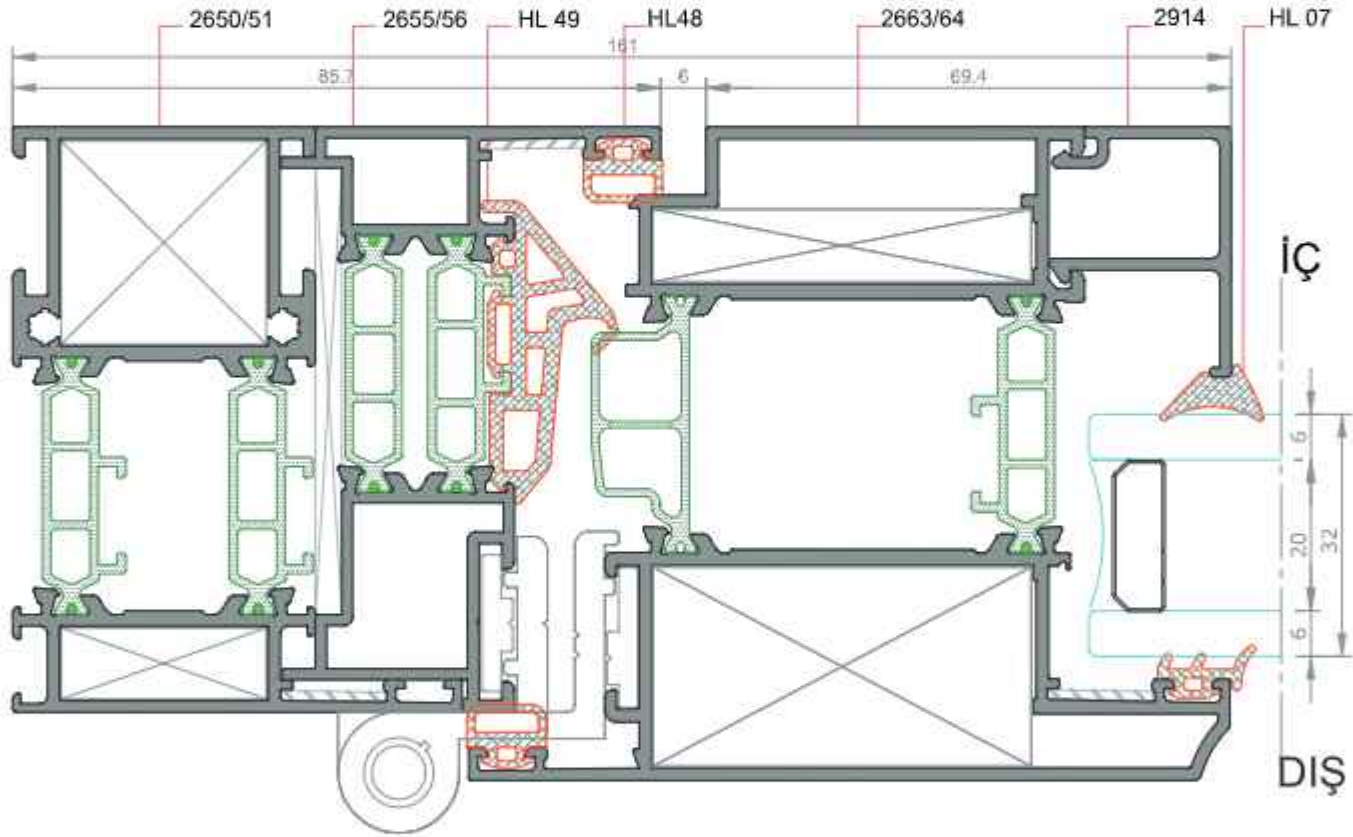

DETAY- 2a
ÖLÇEK:1/1

★ Yandaki profil birim ağırlıkları, bilgisayarda hesaplanmış teorik ağırlıklardır.

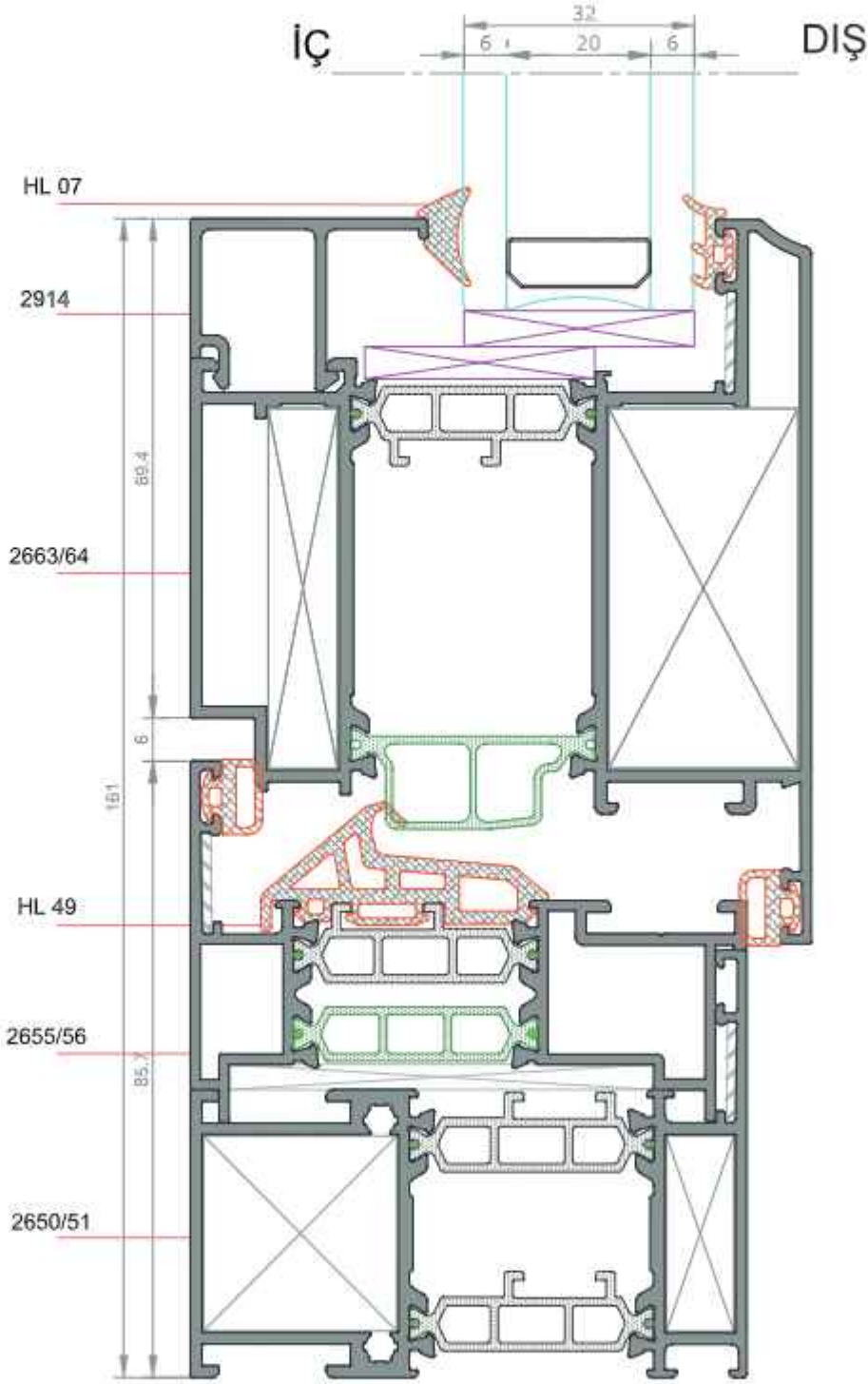

DETAY- 2b
ÖLÇEK:1/1

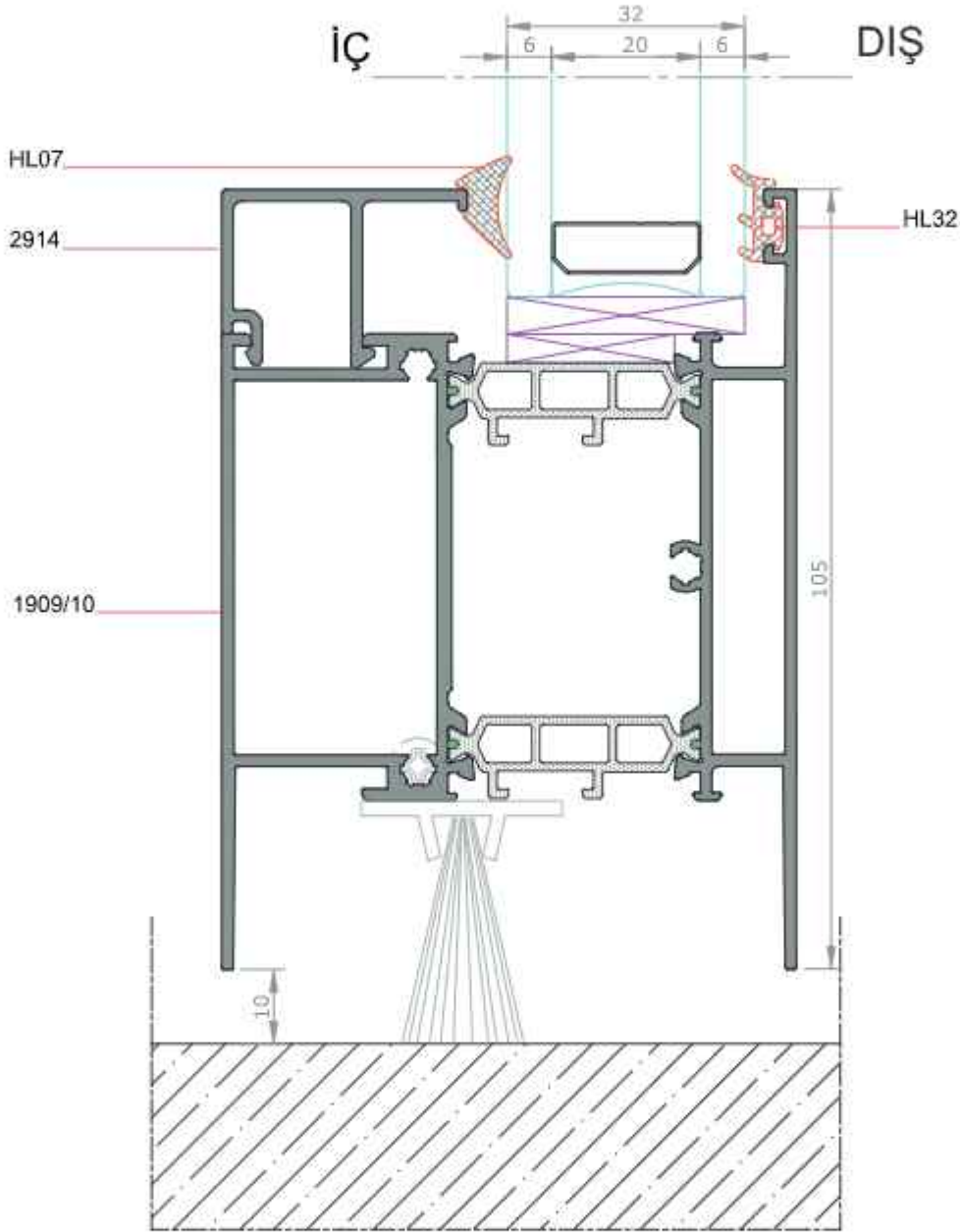

★ Yandaki profil birim ağırlıkları, bilgisayarla hesaplanmış teorik ağırlıklardır.

DETAY- 2c
ÖLÇEK:1/1

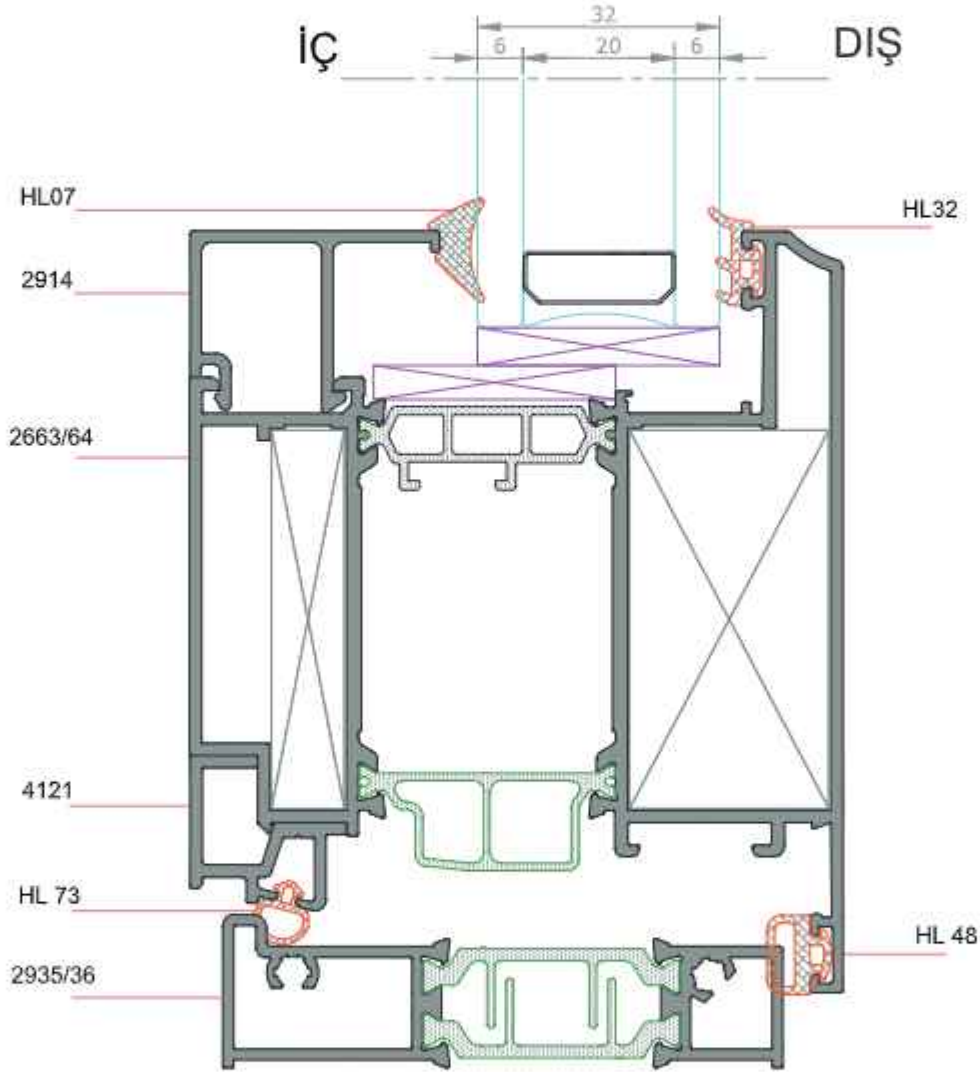
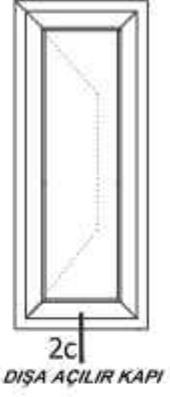

★ Yandaki profil birim ağırlıkları, bilgisayarda hesaplanmış teorik ağırlıklardır.

DETAY- 3
ÖLÇEK:1/1

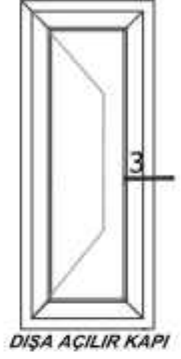

★ Yandaki profil birim ağırlıkları, bilgisayarda hesaplanmış teorik ağırlıklardır.

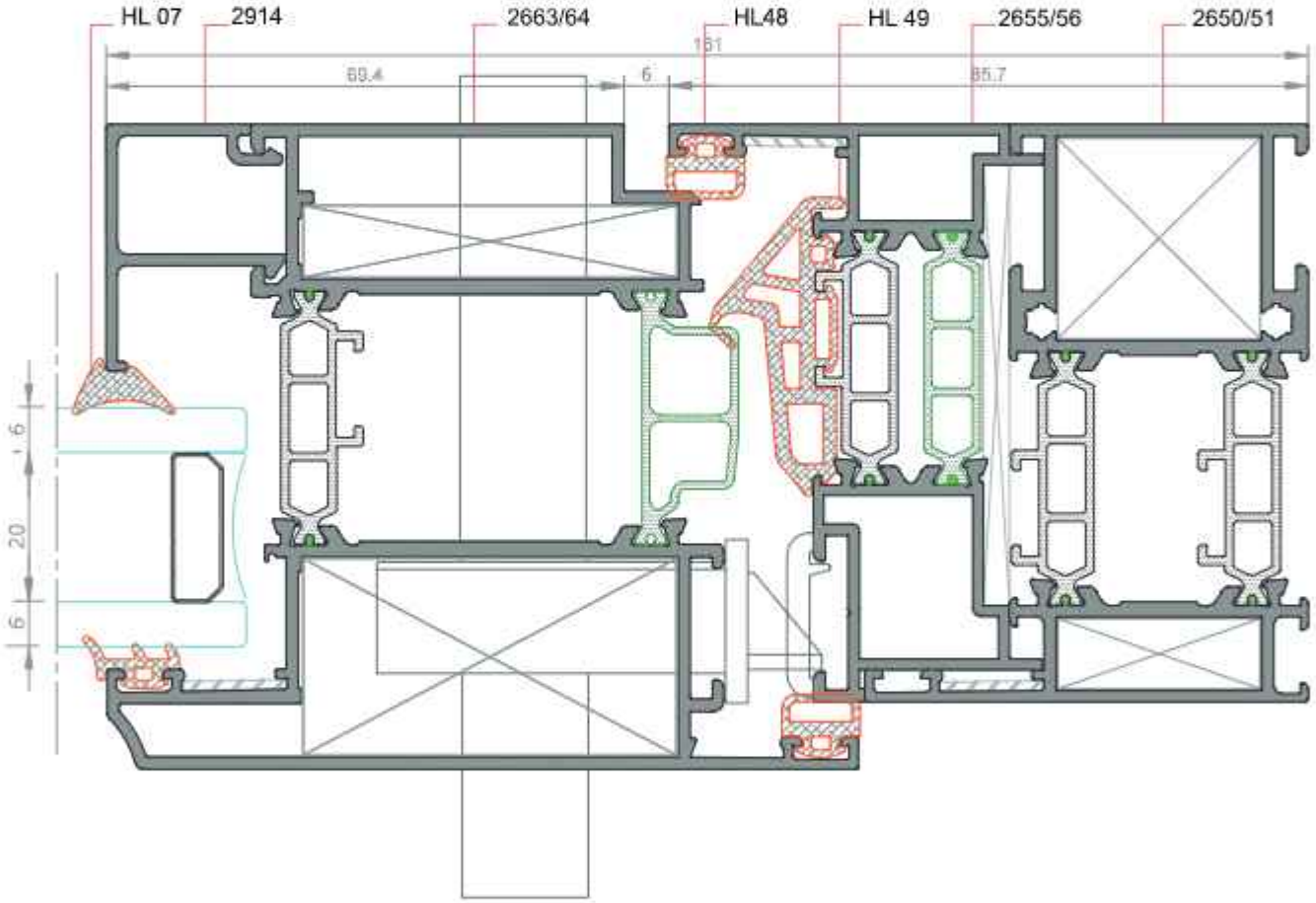

DETAY- 4
ÖLÇEK:1/1

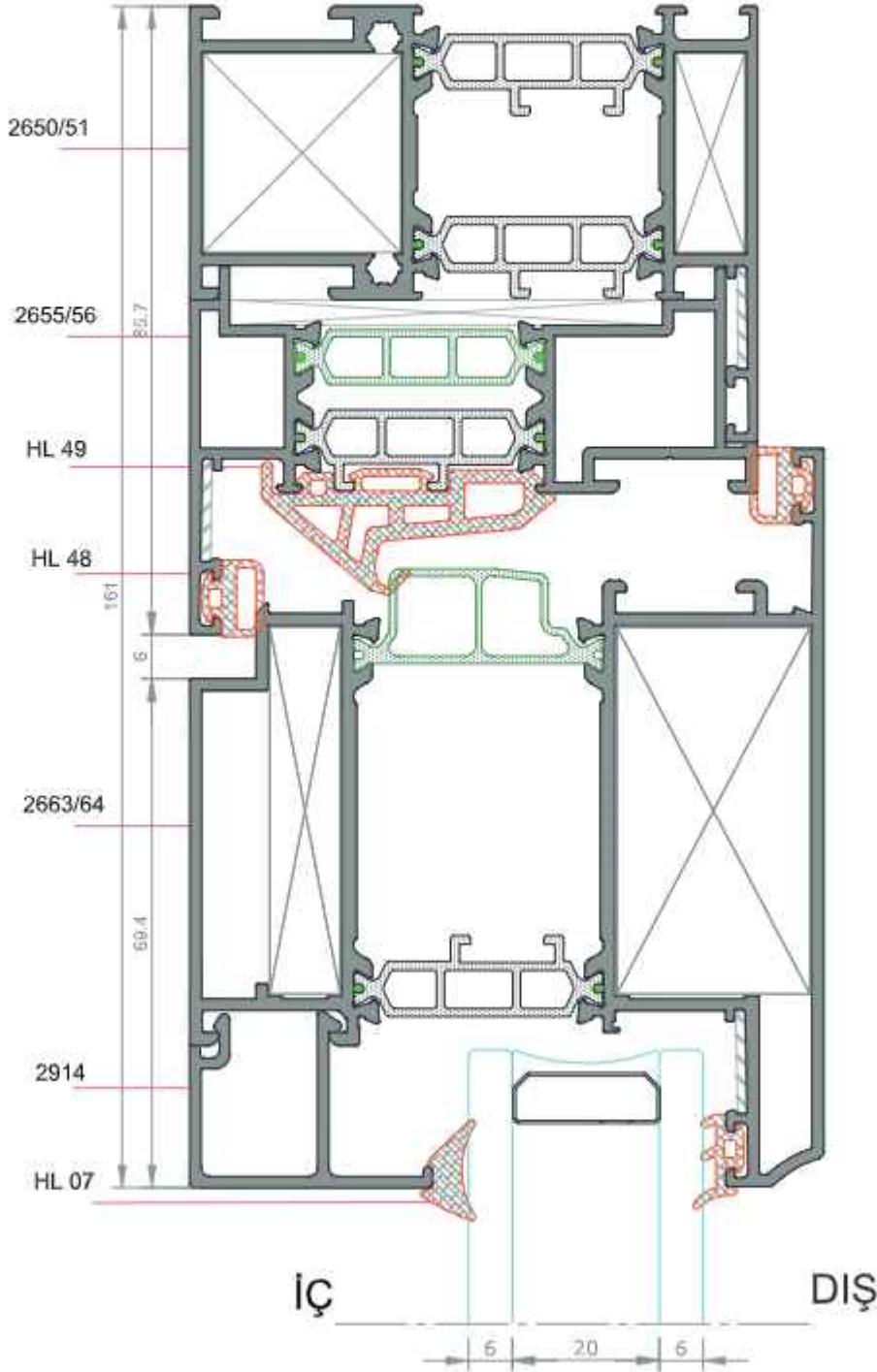
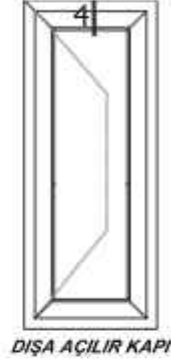

★ Yandaki profil birim ağırlıkları, bilgisayarla hesaplanmış teorik ağırlıklardır.

DETAY- 1
ÖLÇEK:1/1

★ Yandaki profil birim ağırlıkları, bilgisayarla hesaplanmış teorik ağırlıklardır.

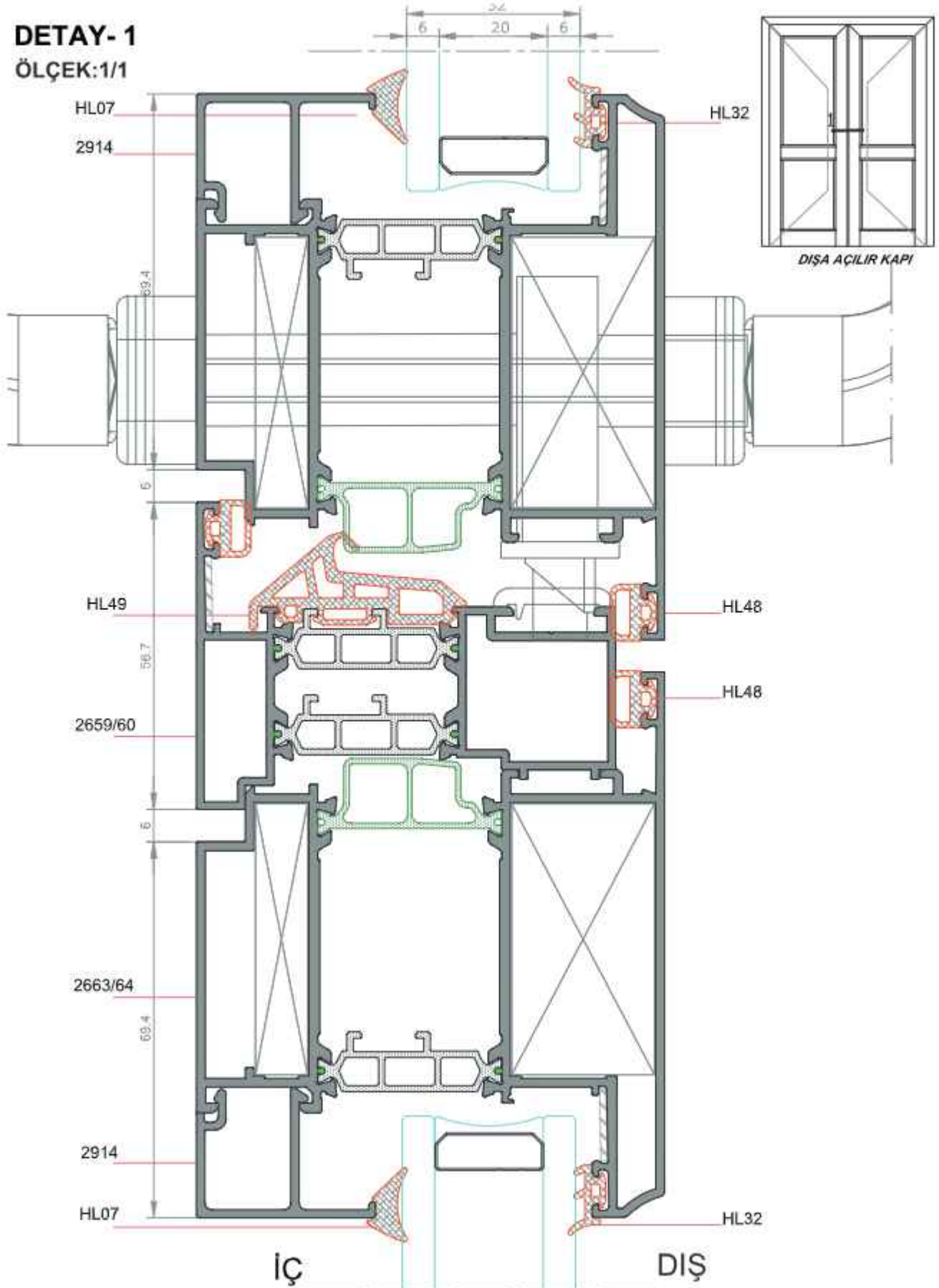

★ Yandaki profil birim ağırlıkları, bilgisayarda hesaplanmış teorik ağırlıklardır.

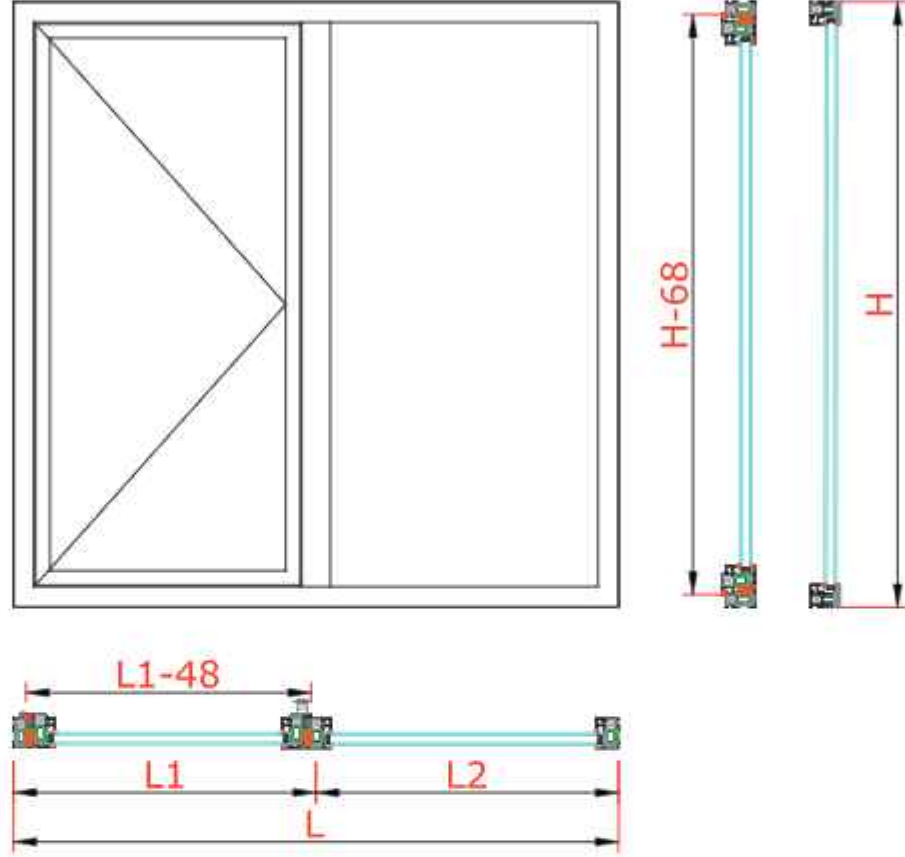

Profilin Adı	Profil Kodu	Profil Kesiti	Adet	Kesim Ölçüsü(mm)
Kasa Profili		2650/51 (1.6mm)	2	L
			2	H
Kanat Profili		2651/52 (1.6mm)	2	L1-48
			2	H-68
Orta Kayıt Profili		2653/54 (1.6mm)	1	H-70,7
Cam Çıtası Profili	Kanat		2	
			2	
Cam Çıtası Profili	Kasa Orta Kayıt		3	
			1	

Bağlantı Elemanları	Kod	Birim	Miktar
Köşe Takozu (Kasa)	K3545 268	Adet	4
Köşe Takozu (Kasa)	K3545 094	Adet	4
Köşe Takozu (Kanat)	K3545 283	Adet	4
Köşe Takozu (Kanat)	K3545 083	Adet	4
Köşe Gönye (Kasa)	MP56-04/3	Adet	4
Köşe Gönye (Kanat)	MP56-04/3	Adet	4

Cam (Açılır)	Adet	Cam Detayı	Kesim Ölçüsü (mm)
Dış Cam	1		
İç Cam			

Cam (Sabit)	Adet	Cam Detayı	Kesim Ölçüsü (mm)
Dış Cam	1		
İç Cam			

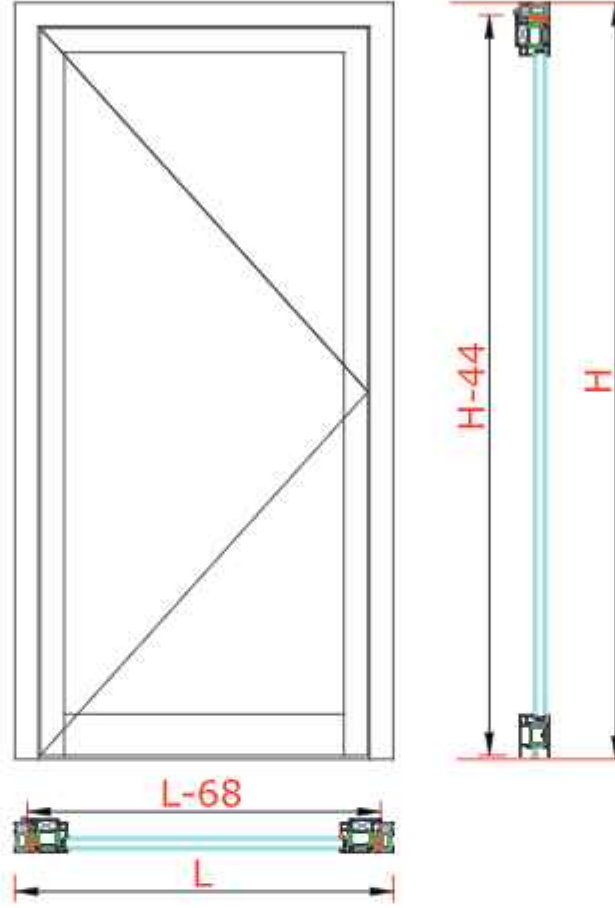

★ Yandaki profil birim ağırlıkları, bilgisayararda hesaplanmış teorik ağırlıklardır.

Profilin Adı	Profil Kodu	Profil Kesiti	Adet	Kesim Ölçüsü(mm)
Kasa Profili		2650/51 (1.6mm)	1	L
			2	H
Kanat Profili		2661/62 (1.6mm)	1	L-68
			2	H-44
Etek Profili		1909/10	1	L-229,3
Cam Çitası Profili <small>Not: Cam Çitası profilleri dışta ve içte kullanılabilir.</small>	Kanat		2	
			1	
Cam Çitası Profili <small>Not: Cam Çitası profilleri dışta ve içte kullanılabilir.</small>	Etek		1	

Bağlantı Elemanları	Kod	Birim	Miktar
Köşe Takozu (Kasa)	K3545 268	Adet	2
Köşe Takozu (Kasa)	K3545 094	Adet	2
Köşe Takozu (Kanat)	K3546 283	Adet	2
Köşe Takozu (Kanat)	K3546 083	Adet	2
Köşe Gönye (Kasa)	MP56-04/3	Adet	2
Köşe Gönye (Kanat)	MP56-04/3	Adet	2

Cam (Açılır)	Adet	Cam Detayı	Kesim Ölçüsü (mm)
Dış Cam	1		
İç Cam			



PROFİL KATALOĐU

GXY 55 HEBESCHIEBE SÜRME SERİ



GXY 55 HEBESCHIEBE SLIDING SERIES

* Profil Ađırlıkları Teorik Olup Teslim Anındaki Ađırlık Geerlidir

* *Weight of profiles are theoretical, net weight will valid at the time of delivery.*



★ Yandaki profil birim ağırlıkları, bilgisayarda hesaplanmış teorik ağırlıklardır.

PROFİL KESİTİ	PROFİL KODU	PROFİL ADI	AĞIRLIK	ATALET MOMENTLERİ		SAYFA NO
				J_x (cm ⁴)	J_y (cm ⁴)	
	3664/65	Kasa Profili	3,512 kg/m	199,68	41,52	
	4584/85	Sabit Kasa Profili	2,846 kg/m	144,28	23,94	
	3407/08	Kanat Profili	2,069 kg/m	44,83	32,91	
	4586/87	Sabit Kanat Profili	2,005 kg/m	46,98	29,04	
	4608/09	Köşe Profili	1,695 kg/m	51,40	10,52	
	4610	Köşe Adaptör Profili	1,014 kg/m	
	4613/4629	Çift Kanat Adaptörü	1,585 kg/m	20,80	13,48	
	3410	Kenet Kapak Profili	0,706 kg/m	
	3561	Ray Profili	0,93 kg/m	
	3503	S.Güneş Kırıcı Alt Kasa Profili	0,926 kg/m	
	3429	S.Güneş Kırıcı Alt Kasa Profili	0,583 kg/m	
	3500	S.Güneş Kırıcı Üst Kapak Profili	0,272 kg/m	
	3502	Güneş Kırıcı Profili	0,556 kg/m	
	3405	S.Güneş Kırıcı Ray Profili	0,483 kg/m	

PROFİL KESİTİ	PROFİL KODU	PROFİL ADI	AĞIRLIK	ATALET MOMENTLERİ		SAYFA NO
				J_x (cm ⁴)	J_y (cm ⁴)	
	4181	Cam Çıtası	0,209 kg/m	
	4182	Cam Çıtası	0,236 kg/m	
	4183	Cam Çıtası	0,248 kg/m	
	3409	Cam Çıtası	0,262 kg/m	
	4184	Cam Çıtası	0,276 kg/m	
	4185	Cam Çıtası	0,286 kg/m	
	3413	Cam Çıtası	0,369 kg/m	
	4590	Basamak Çıtası	0,670 kg/m	
	4588	Orta Bağlantı Profili	1,051 kg/m	
	4589	Orta Bağlantı Profili	0,552 kg/m	
	3429	Köşe Takoğu	4,569 kg/m	
	3224	Köşe Takoğu	3,459 kg/m	
	2929	Köşe Takoğu	3,341 kg/m	

★ Yandaki profil birim ağırlıkları, bilgisayarda hesaplanmış teorik ağırlıklardır.

AKSESUAR KESİTİ	AKSESUAR KODU	AKSESUAR ADI	AĞIRLIK	PAKETLEME	SAYFA NO
	HL25	Cam Yatak Fitili	44 gr/m	15kg/ 340m	
	HL62	Kanat Fitili	47 gr/m	15kg/ 319m	
	HL58	Kenet Fitili	312 gr/m	15kg/ 48m	
	HL31(2mm)	Kama Fitili	40 gr/m	15kg/ 375m	
	HL04(3mm)	Kama Fitili	60 gr/m	15kg/ 250m	
	HL07(4mm)	Kama Fitili	63 gr/m	15kg/ 238m	
	HL02(4.5mm)	Kama Fitili	70 gr/m	15kg/ 175m	
	HL110	Basamak Çıtası Altı Fitili	165 gr/m	15kg/ 98m	
	HL111	Köşe Fitili	40 gr/m	15kg/ 375m	
	HL112	Köşe Adaptör Fitili	57 gr/m	15kg/ 263m	
	HL63	Ray Kapama	26 gr/m	15kg/ 576m	
	MP-B9576	U Profili	0,215 kg/m	15kg/ 163m	
	4606	U Profili	0,350 kg/m	...	

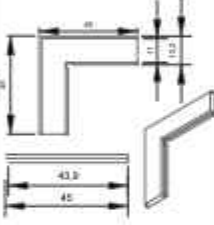
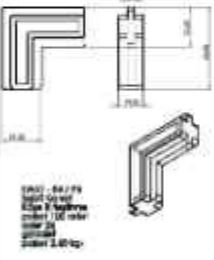
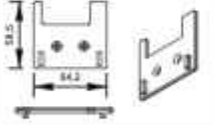
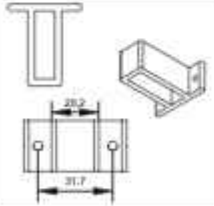
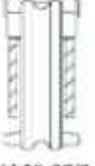
AKSESUAR KESİTİ	AKSESUAR KODU	AKSESUAR ADI	AĞIRLIK	PAKETLEME	SAYFA NO
	3561	Çelik Ray	
 HA 26-05/4 Su Tahliye Kapağı	MP26-05/4	Su Tahliye Kapağı	...	100Ad/ 1Paket	
	MP56-04/5	Köşe Gönye	...	1 Ad/ Paket	
 MP61-84/P6 Sabit Kanat Köşe Birleştirme	MP61-84/P6	Sabit Kanat Köşe Birleştirme	...	1 Ad/ Paket	
	MP30-11/4	Ray Kanal Kapağı (Sağ-Sol)	...	1Tk/ Paket	
	MP61-84/P7	Sabitleme Takozu	...	1 Ad/ Paket	
 HA33-07/8 HEBESCHIEBE RULMAN	MP33-07/8	Hebeschiebe Rulman	...	1 Ad/ Paket	

AKSESUAR KESİTİ	AKSESUAR KODU	AKSESUAR ADI	AĞIRLIK	PAKETLEME	SAYFA NO
 HA 60-Y6/2 Araba	MP60-Y6/2	Araba	
 HE-9100 Zincir 42 (1/2) Ağırlık 50/50/50 F102-332 Sliding Wheel 08/1352	HE-9100	Sürme Kıl Fitili	
	MP42-36/1	Alt-Üst Tozluk Fitili	
 HA 32-10/3 HAVUZ KOL (PROFİL KESİM) KOLU ADET : 400 KOLU AĞIRLIĞI : 0,5/0,400	MP32-10/3	Havuz Kol	
	MP32-11/GRS HE-9500	Yaylı Havuz Kol	

★ Yandaki profil birim ağırlıkları, bilgisayarda hesaplanmış teorik ağırlıklardır.

3664/65

Kasa Profili

3,511 kg/m

$J_x=199,67 \text{ cm}^4$ $J_y=41,53 \text{ cm}^4$

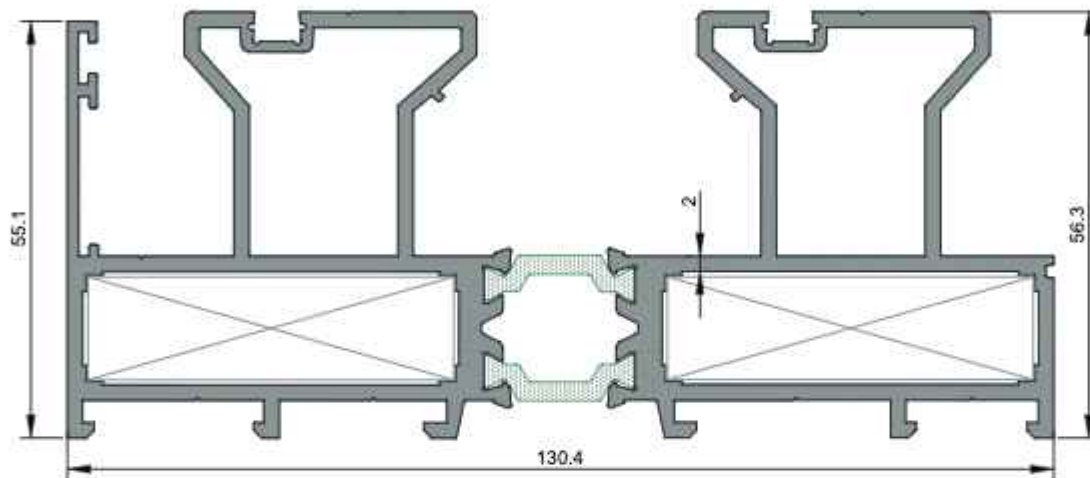

4584/85

Sabit Kasa Profili

2,846 kg/m

$J_x=152,04 \text{ cm}^4$ $J_y=24,05 \text{ cm}^4$

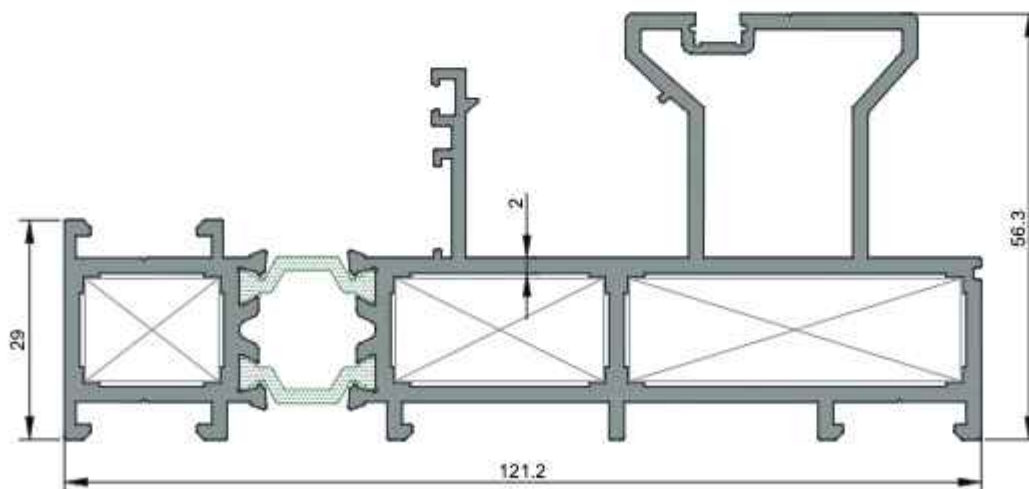

★ Yandaki profil birim ağırlıkları, bilgisayarla hesaplanmış teorik ağırlıklardır.

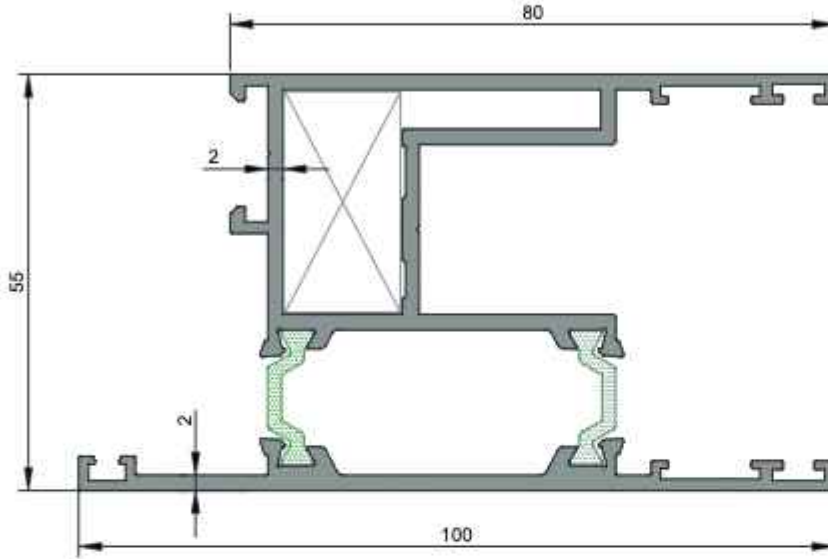

3407/08

Kanat Profili

2,069 kg/m

$J_x=44,83 \text{ cm}^4$ $J_y=32,91 \text{ cm}^4$

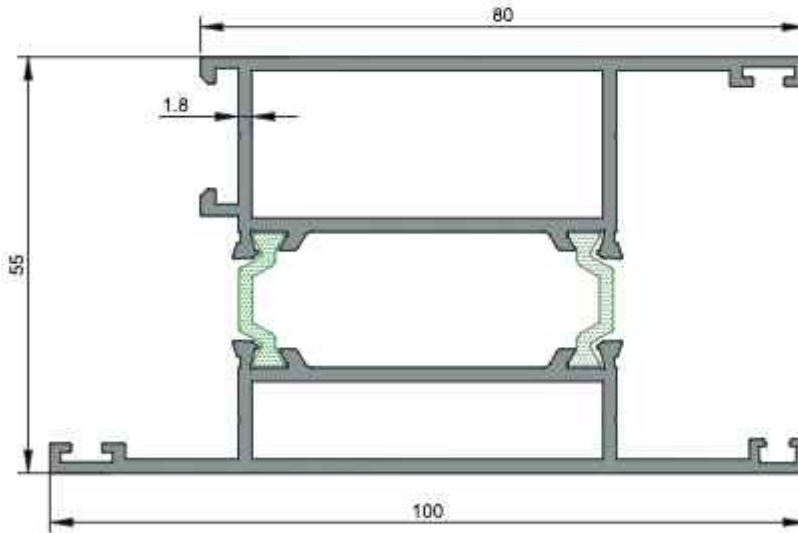

4586/87

Sabit Kanat Profili

2,005 kg/m

$J_x=46,98 \text{ cm}^4$ $J_y=29,04 \text{ cm}^4$

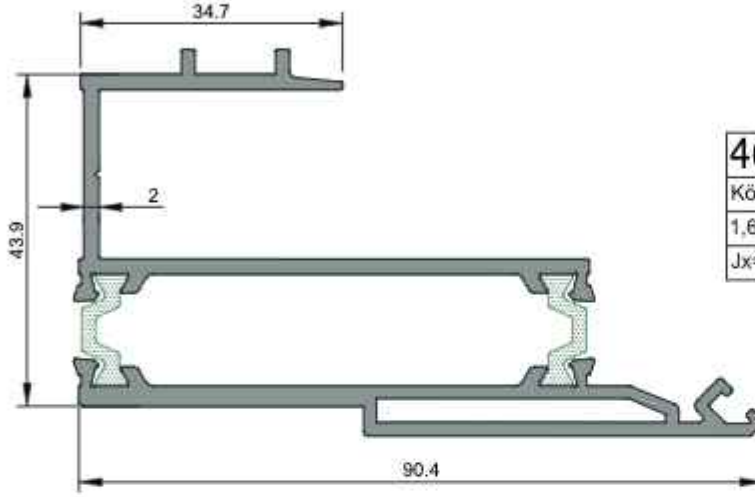

4608/09
Köşe Profili
1,695 kg/m
$J_x=51,40 \text{ cm}^4$ $J_y=10,52 \text{ cm}^4$

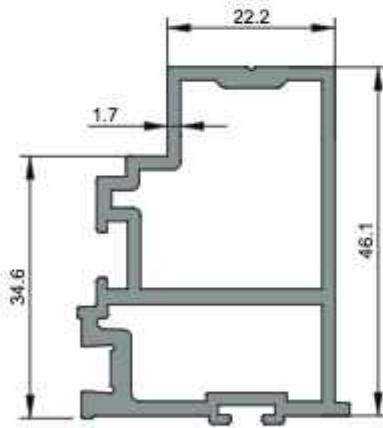

4610
Köşe Adaptör Profili
1,014 kg/m

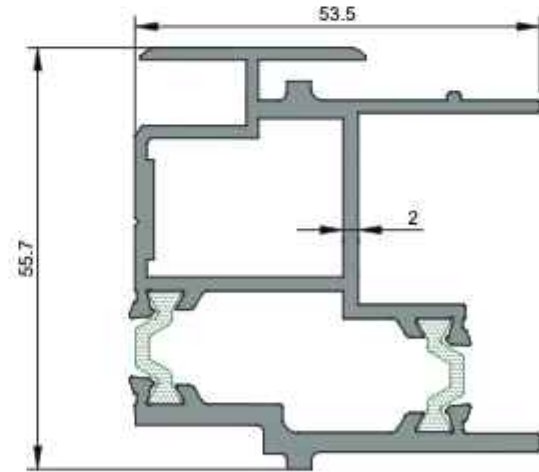

4613/4629
Çift Kanat Adaptörü
1,585 kg/m
$J_x=20,80 \text{ cm}^4$ $J_y=13,48 \text{ cm}^4$

★ Yandaki profil birim ağırlıkları, bilgisayarda hesaplanmış teorik ağırlıklardır.

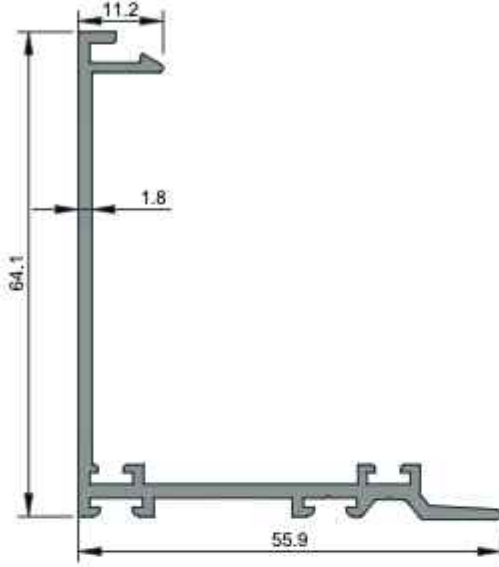

3410
Kenet Kapak Profili
0,706 kg/m

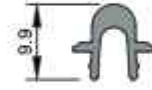

3561
Ray Profili
0,093 kg/m

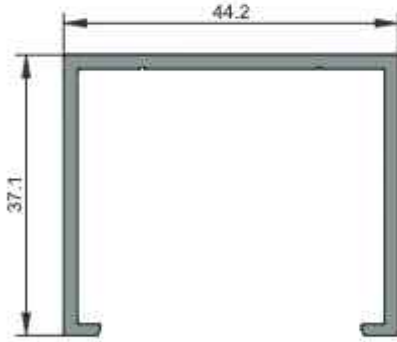

3501
S. Güneş Kırıcı Alt Kasa Profili
0,583 kg/m

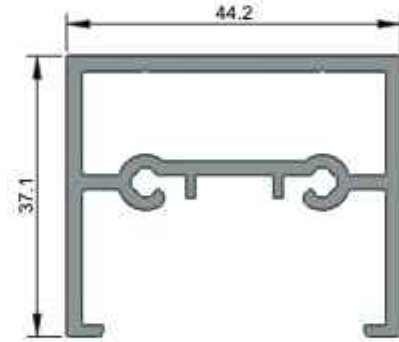

3503
S. Güneş Kırıcı Alt Kasa Profili
0,926 kg/m

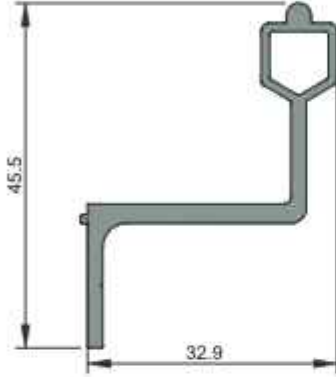

3405

S.Güneş Kırıcı Ray Profili
0,483 kg/m

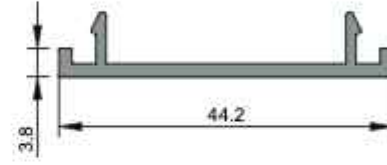

3500

S.Güneş Kırıcı Üst Kapak Profili
0,272 kg/m

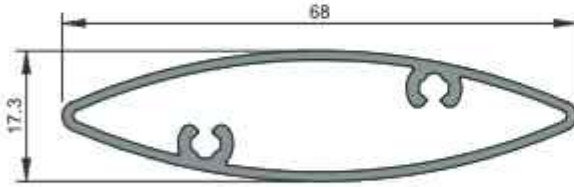

3502

Güneş Kırıcı Profili
0,556 kg/m

★ Yandaki profil birim ağırlıkları, bilgisayarda hesaplanmış teorik ağırlıklardır.

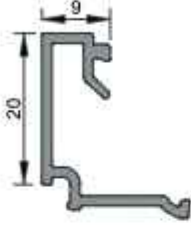

4181
Cam Çıtası
0,209 kg/m

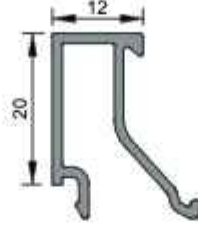

4182
Cam Çıtası
0,236 kg/m

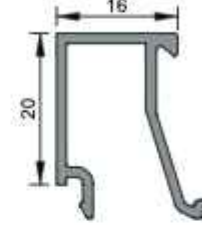

4183
Cam Çıtası
0,248 kg/m

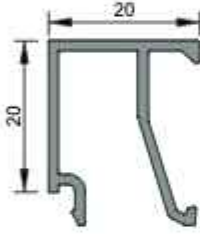

3409
Cam Çıtası
0,262 kg/m

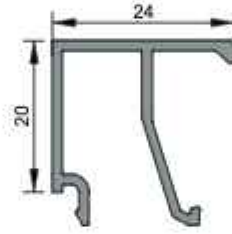

4184
Cam Çıtası
0,276 kg/m

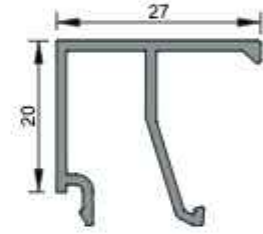

4185
Cam Çıtası
0,286 kg/m

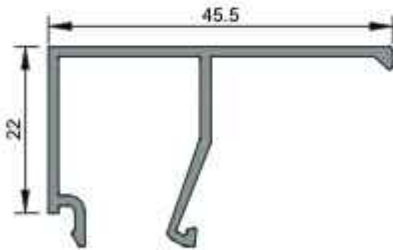

3413
Cam Çıtası
0,369 kg/m

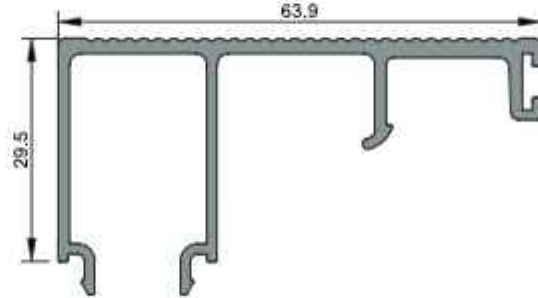

4590
Basamak Çıtası
0,724 kg/m

ÇEKTİRME TAKOZU KESİM ÖLÇÜLERİ

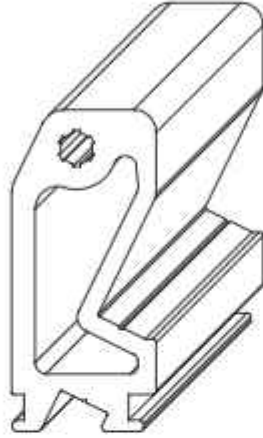

4588

Orta Bağlantı Takozu

1,051 kg/m

Aksesuar Kodu	Profil Kodu	Kesim Ölçüsü A(mm)
C4488 046	4486/4487	46

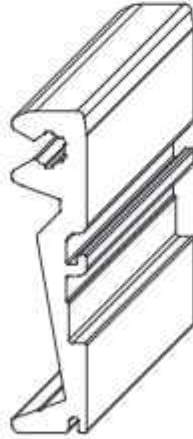

4589

Orta Bağlantı Takozu

0,552 kg/m

Aksesuar Kodu	Profil Kodu	Kesim Ölçüsü A(mm)
C4489 046	4486/4487	46

★ Yandaki profil birim ağırlıkları, bilgisayarda hesaplanmış teorik ağırlıklardır.

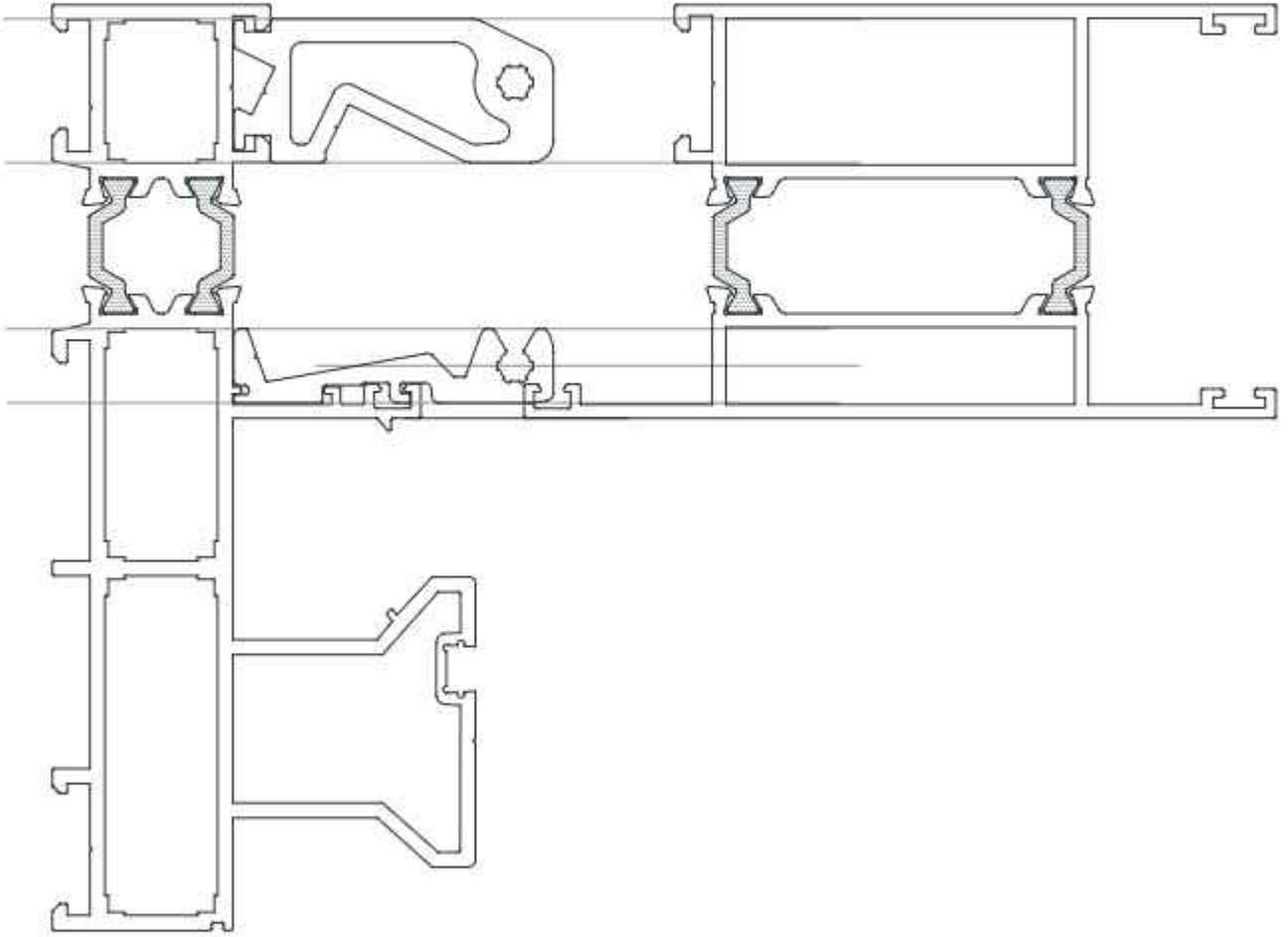

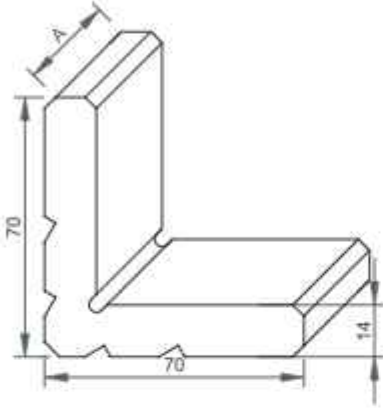

3429

Kanat Köşe Takoğu

4,569 kg/m

Aksesuar Kodu	Profil Kodu	Kesim Ölçüsü A(mm)
K3429 405	3664/3665	40.5
K3429 177	4584/4585	17.7
K3429 275	4584/4585	27.5
K3429 445	4584/4585	44.5

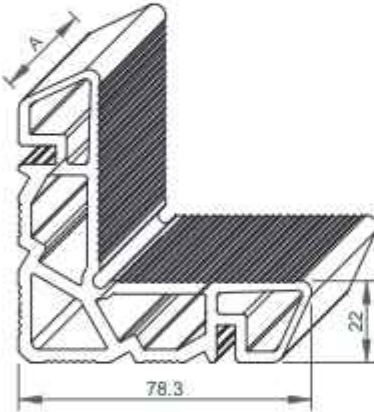

3224

Kasa Takoğu

3,459 kg/m

Aksesuar Kodu	Profil Kodu	Kesim Ölçüsü A(mm)
K3224 456	3396	45.6
K3224 422	3396	42.2

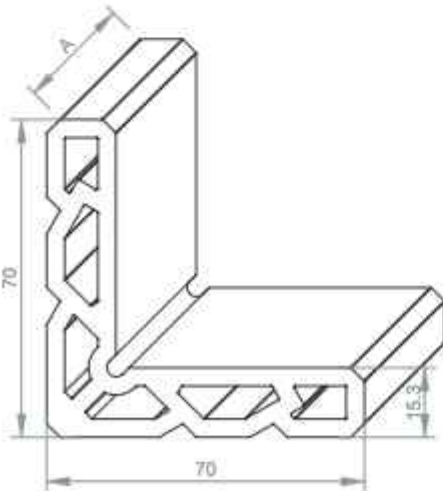

2929

Köşe Takoğu

3,341 kg/m

Aksesuar Kodu	Profil Kodu	Kesim Ölçüsü A(mm)
K2929 292	3407/3408	29.2

ÖLÇEK:1/1

CAMLAMA SEÇENEK TABLOSU

Cam Kalınlığı - Cam Çıtası Yüksekliği	Fitel Kodu	Profil
9	HL 07	4181
	HL 04	
	HL 31	
12	HL 07	4182
	HL 04	
	HL 31	
16	HL 07	4183
	HL 04	
	HL 31	
20	HL 07	3409
	HL 04	
	HL 31	
24	HL 07	4184
	HL 04	
	HL 31	
27	HL 07	4185
	HL 04	
	HL 31	

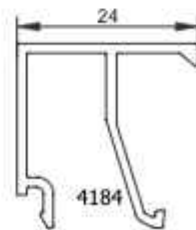
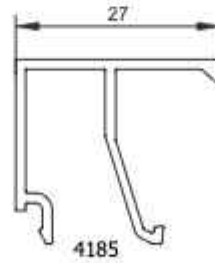
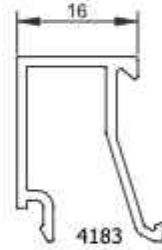
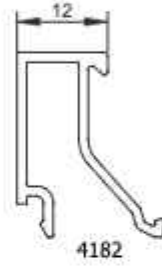
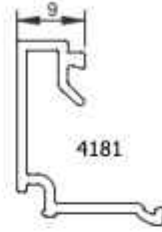

★ Yandaki profil birim ağırlıkları, bilgisayarla hesaplanmış teorik ağırlıklardır.

DETAY-1
ÖLÇEK:1/1

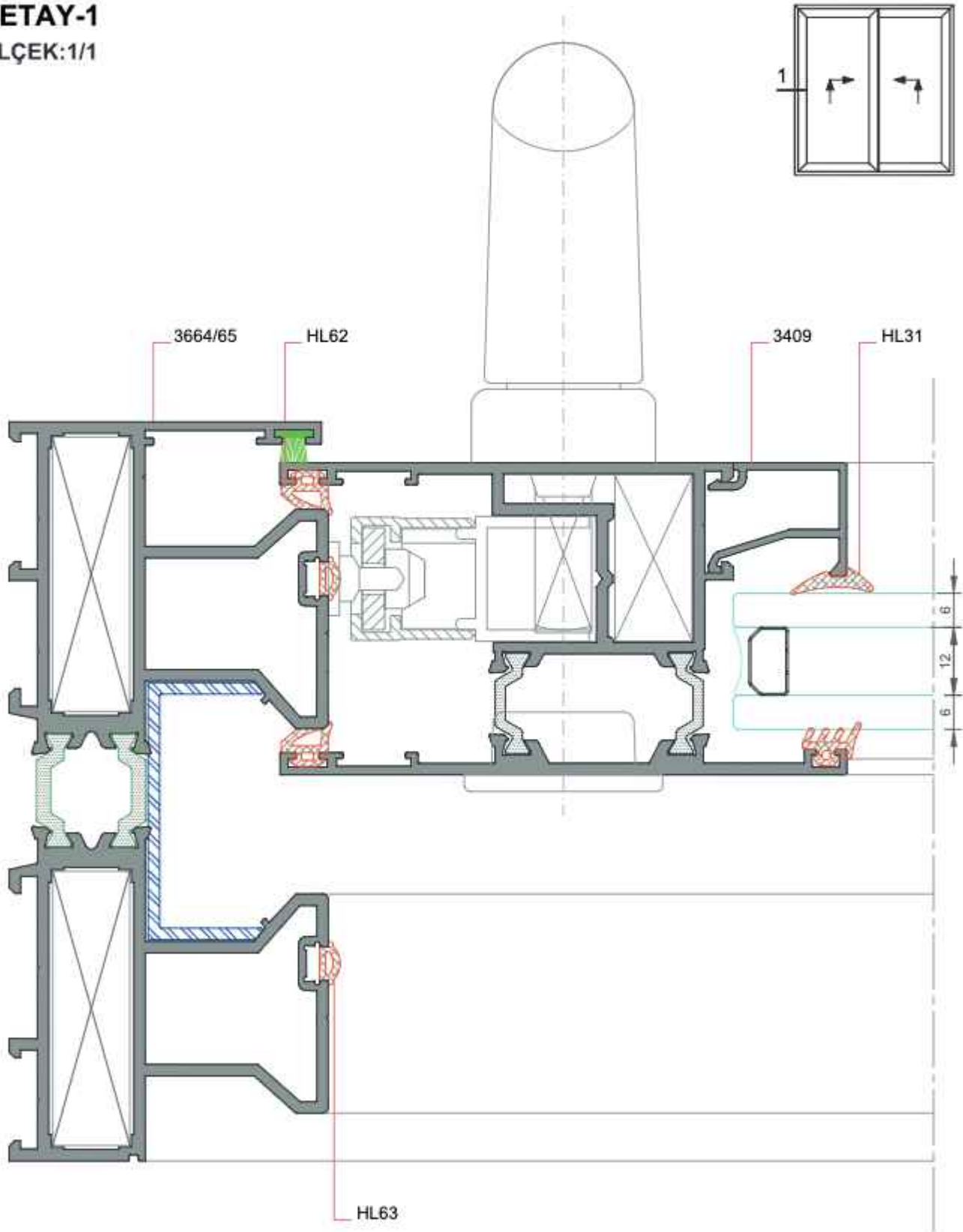

DETAY-2
ÖLÇEK:1/1

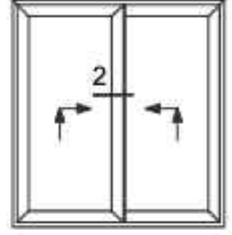

★ Yandaki profil birim ağırlıkları, bilgisayarla hesaplanmış teorik ağırlıklardır.

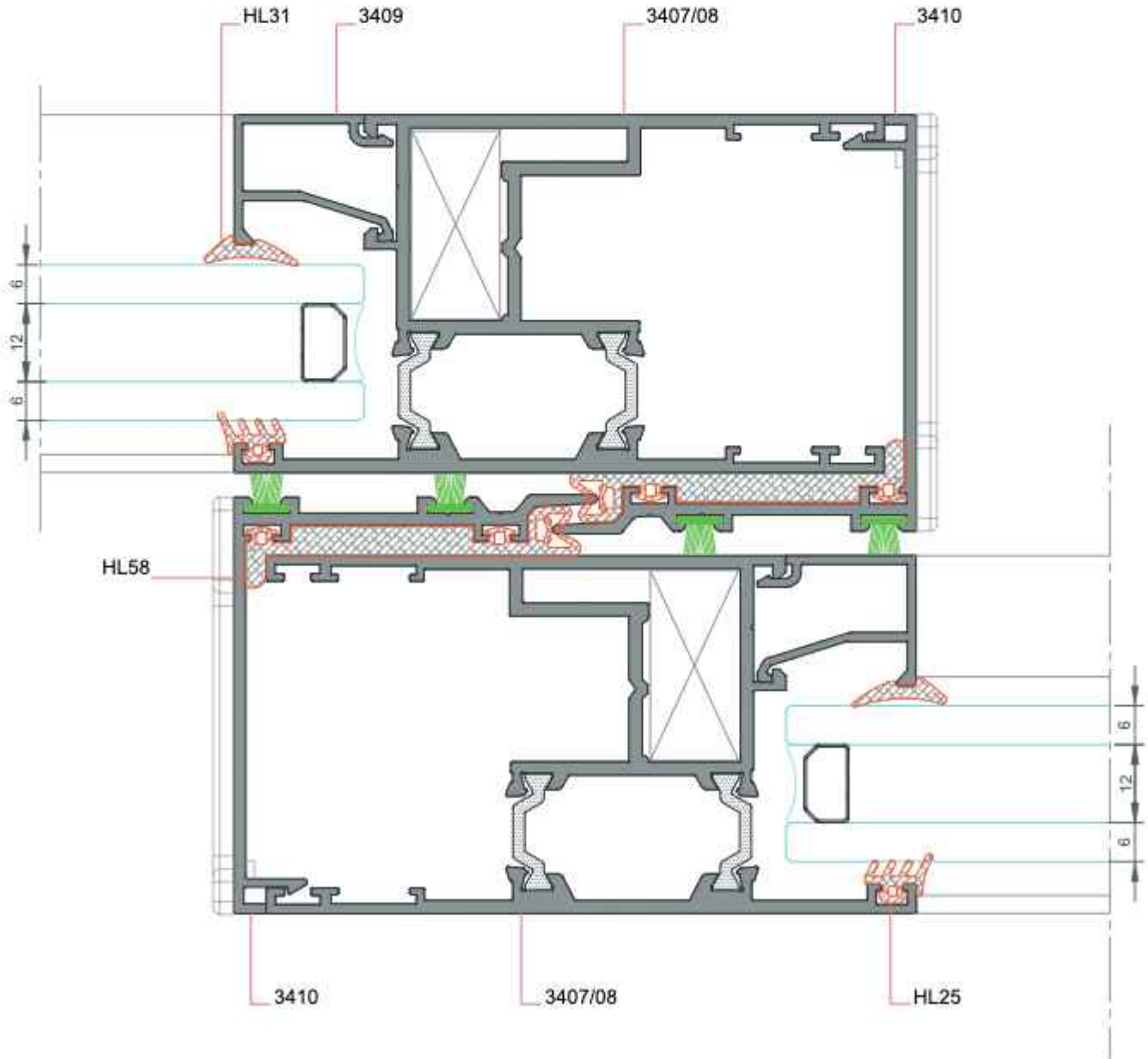

DETAY-3
ÖLÇEK:1/1

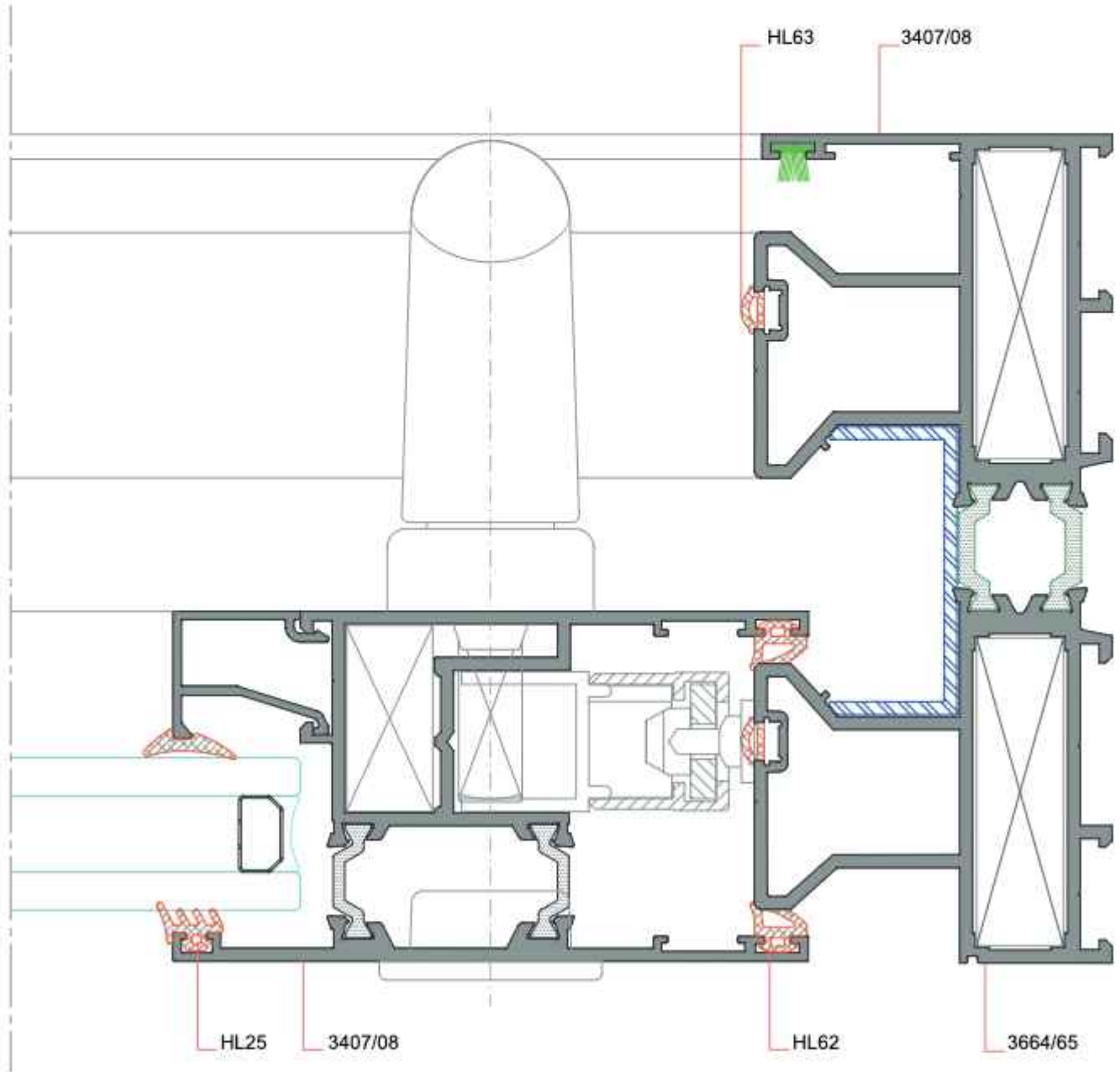
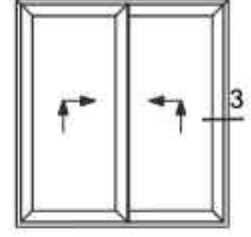

DETAY-4
ÖLÇEK:1/1

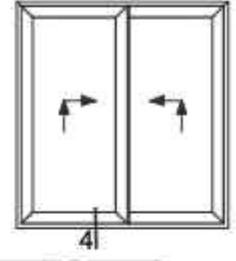

★ Yandaki profil birim ağırlıkları, bilgisayararda hesaplanmış teorik ağırlıklardır.

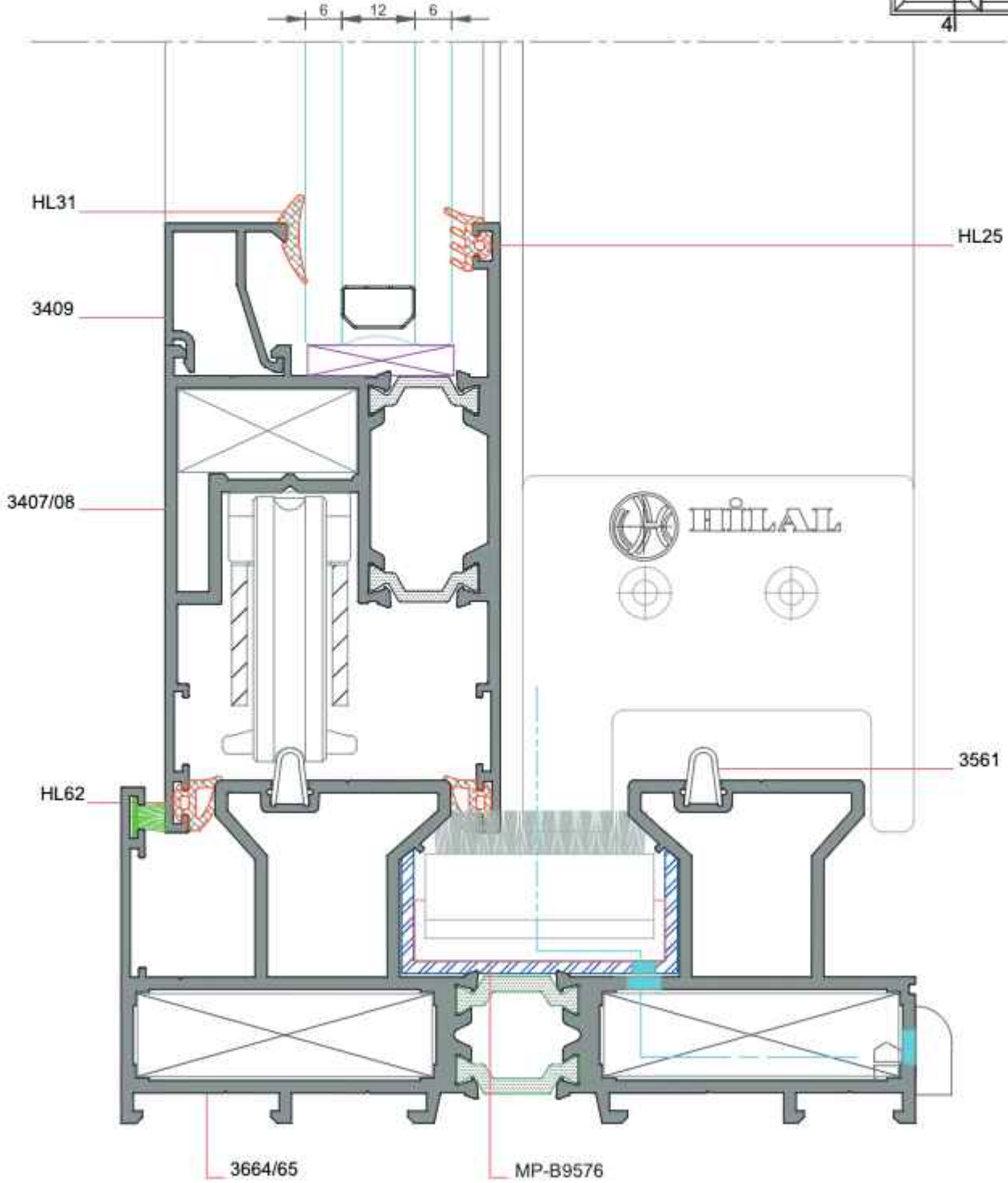

DETAY-5
ÖLÇEK:1/1

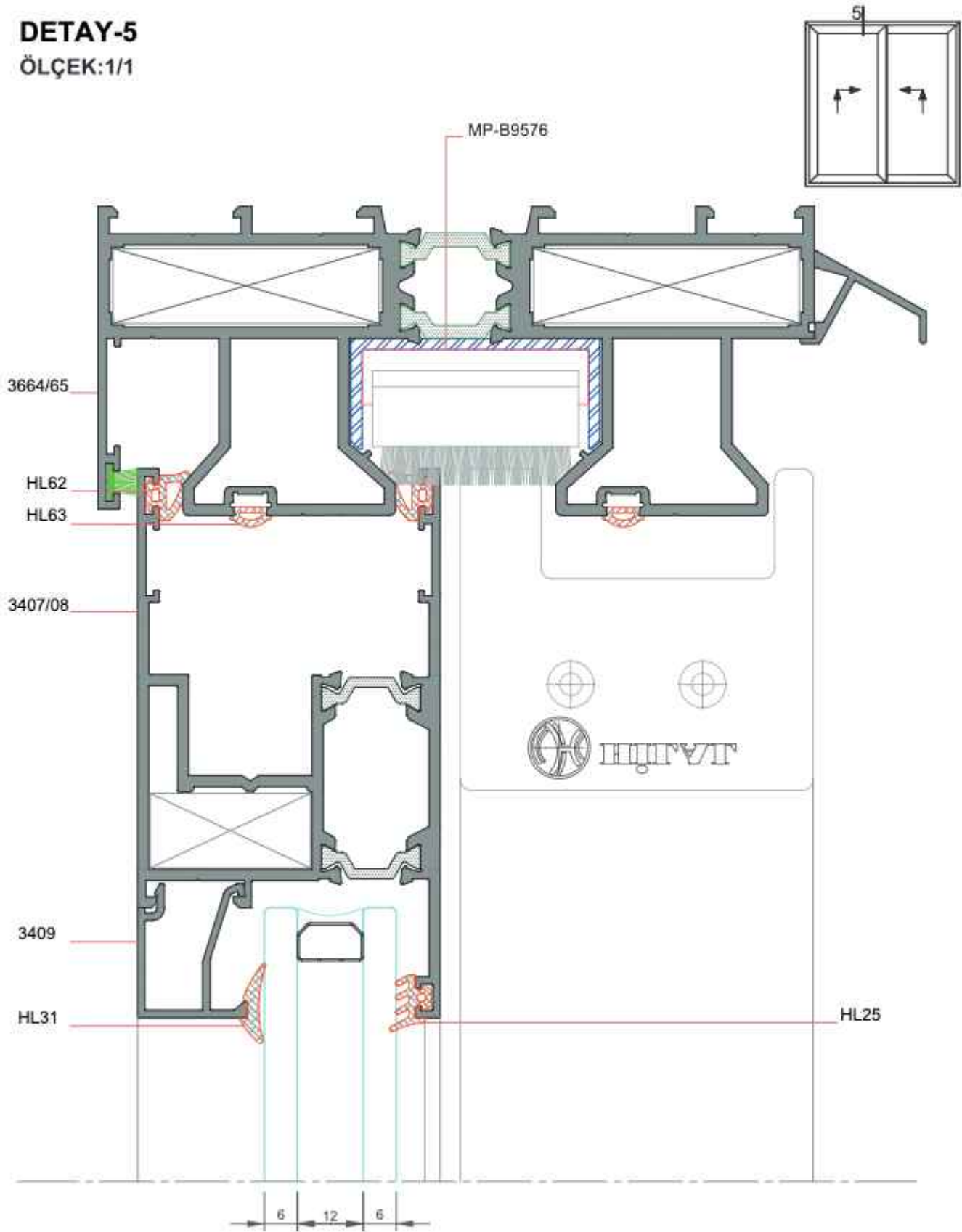

DETAY-1
ÖLÇEK:1/1

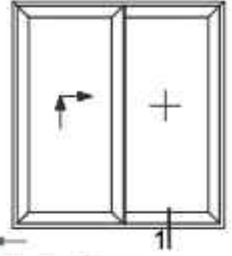

★ Yandaki profil birim ağırlıkları, bilgisayarla hesaplanmış teorik ağırlıklardır.

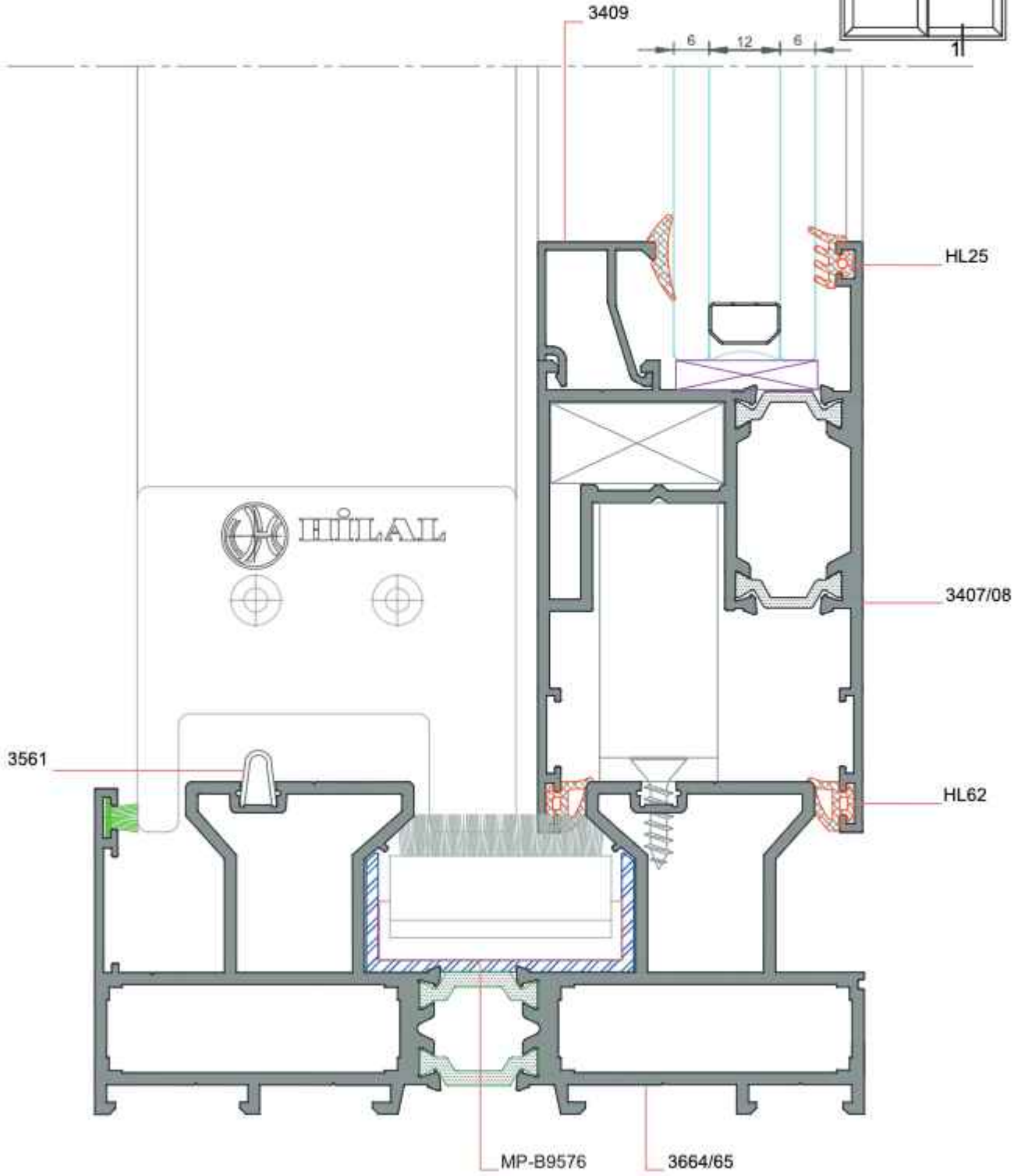

DETAY-1
ÖLÇEK:1/1

HL25

3409

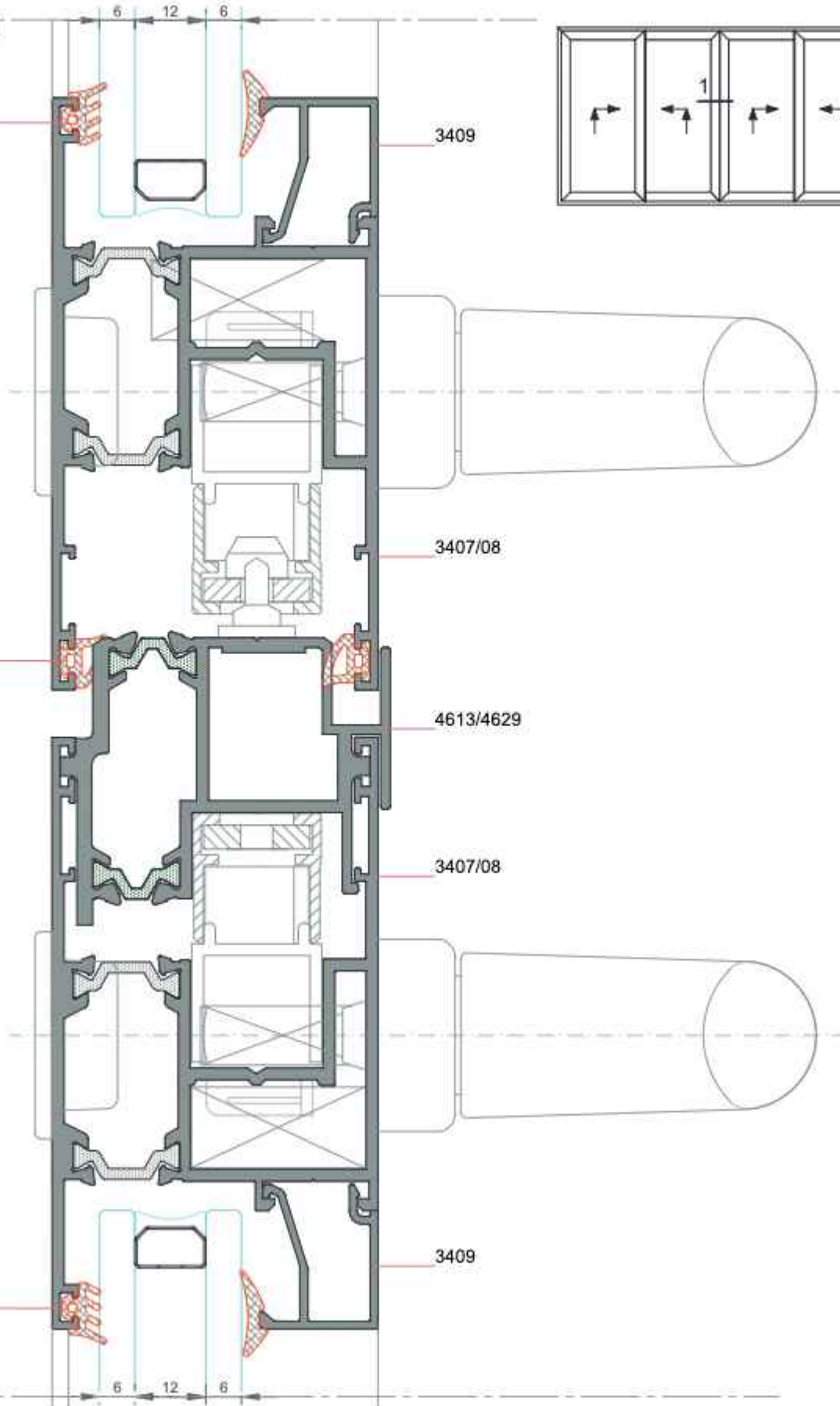
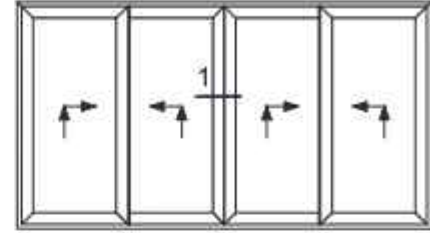

DETAY-1
ÖLÇEK:1/1

★ Yandaki profil birim ağırlıktan, bilgisayarda hesaplanmış teorik ağırlıklardır.

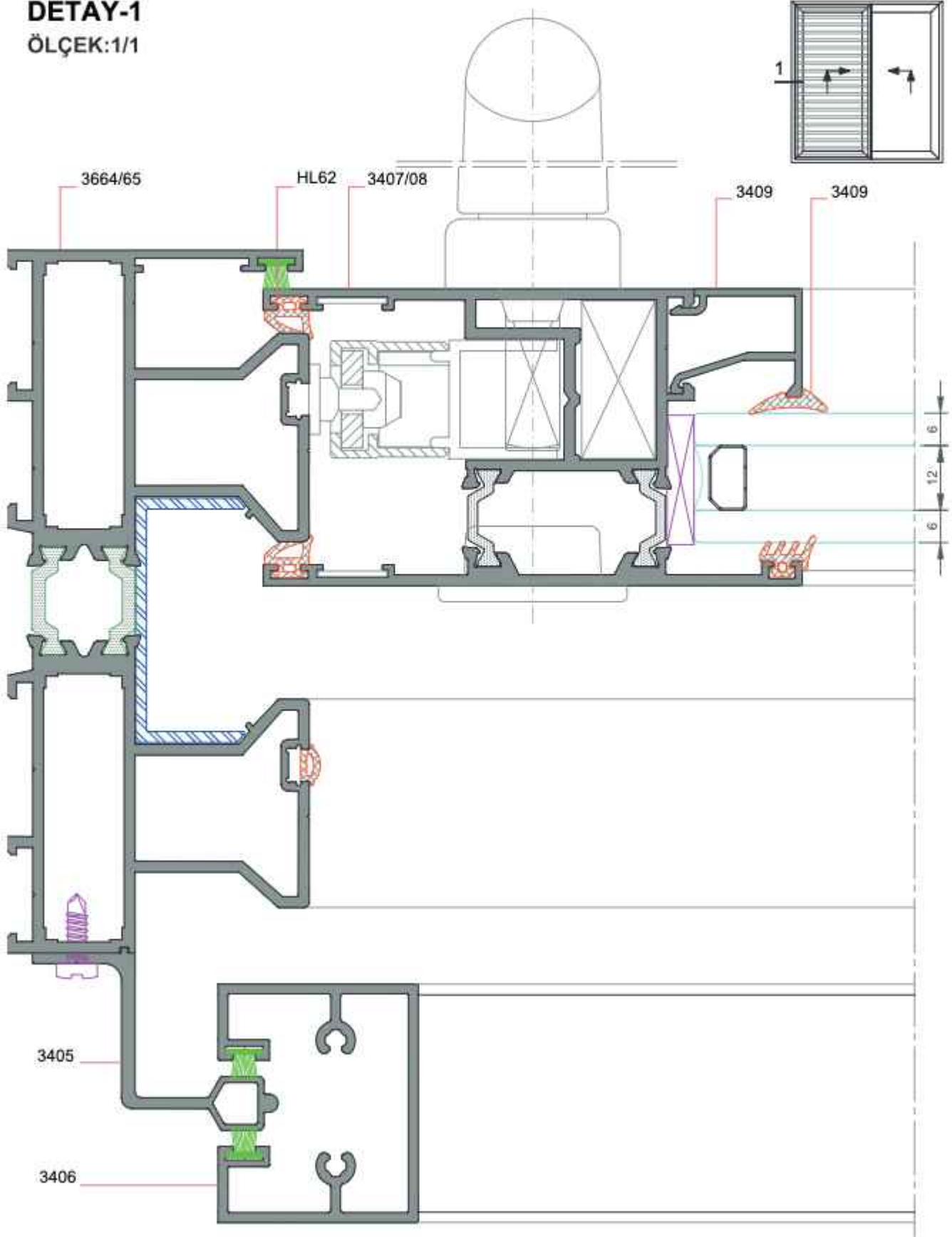

DETAY-2
ÖLÇEK:1/1

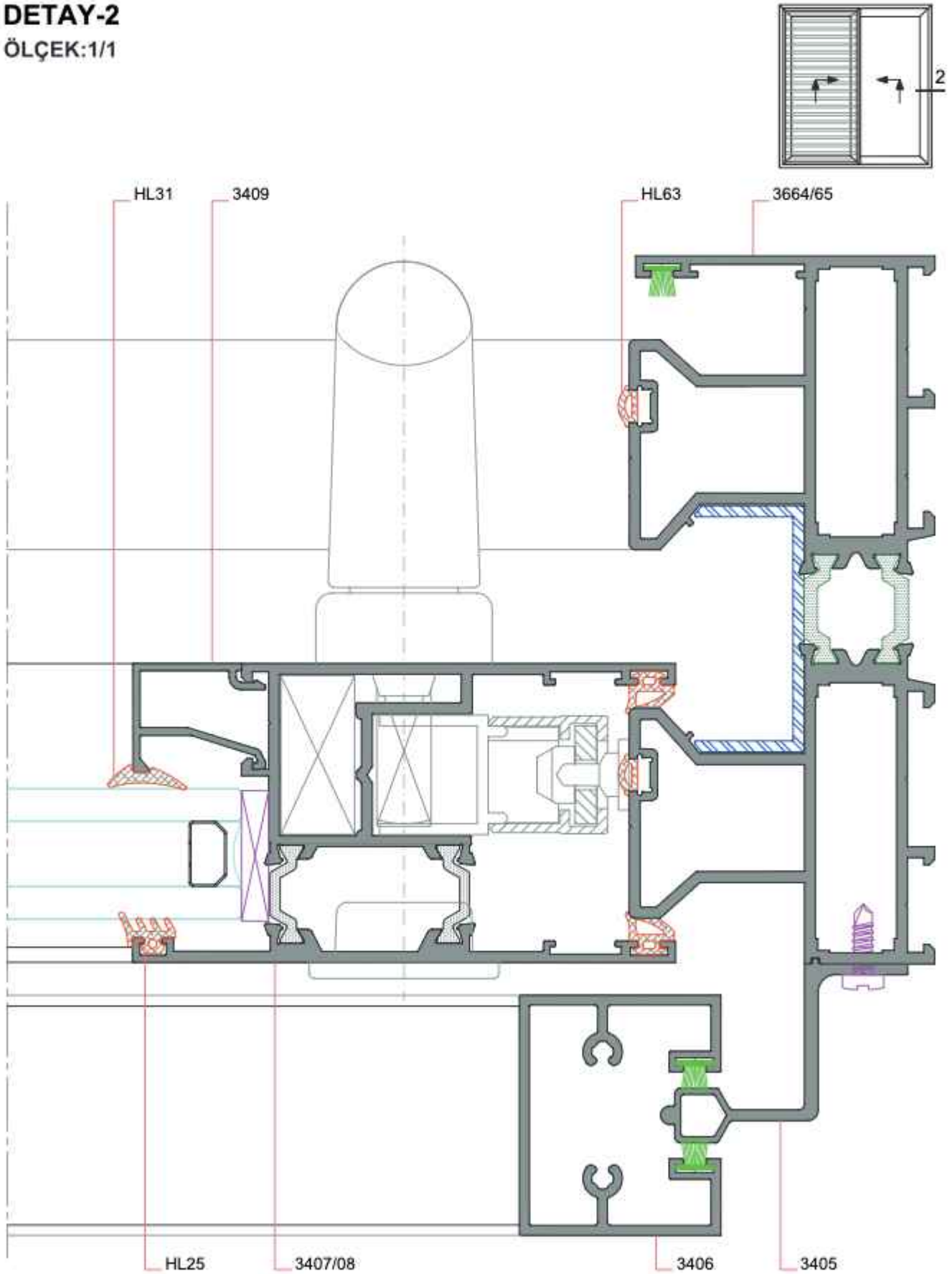

DETAY-3
ÖLÇEK:1/1

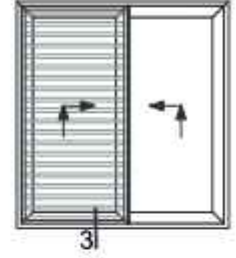

★ Yandaki profil birim ağırlıkları, bilgisayarla hesaplanmış teorik ağırlıklardır.

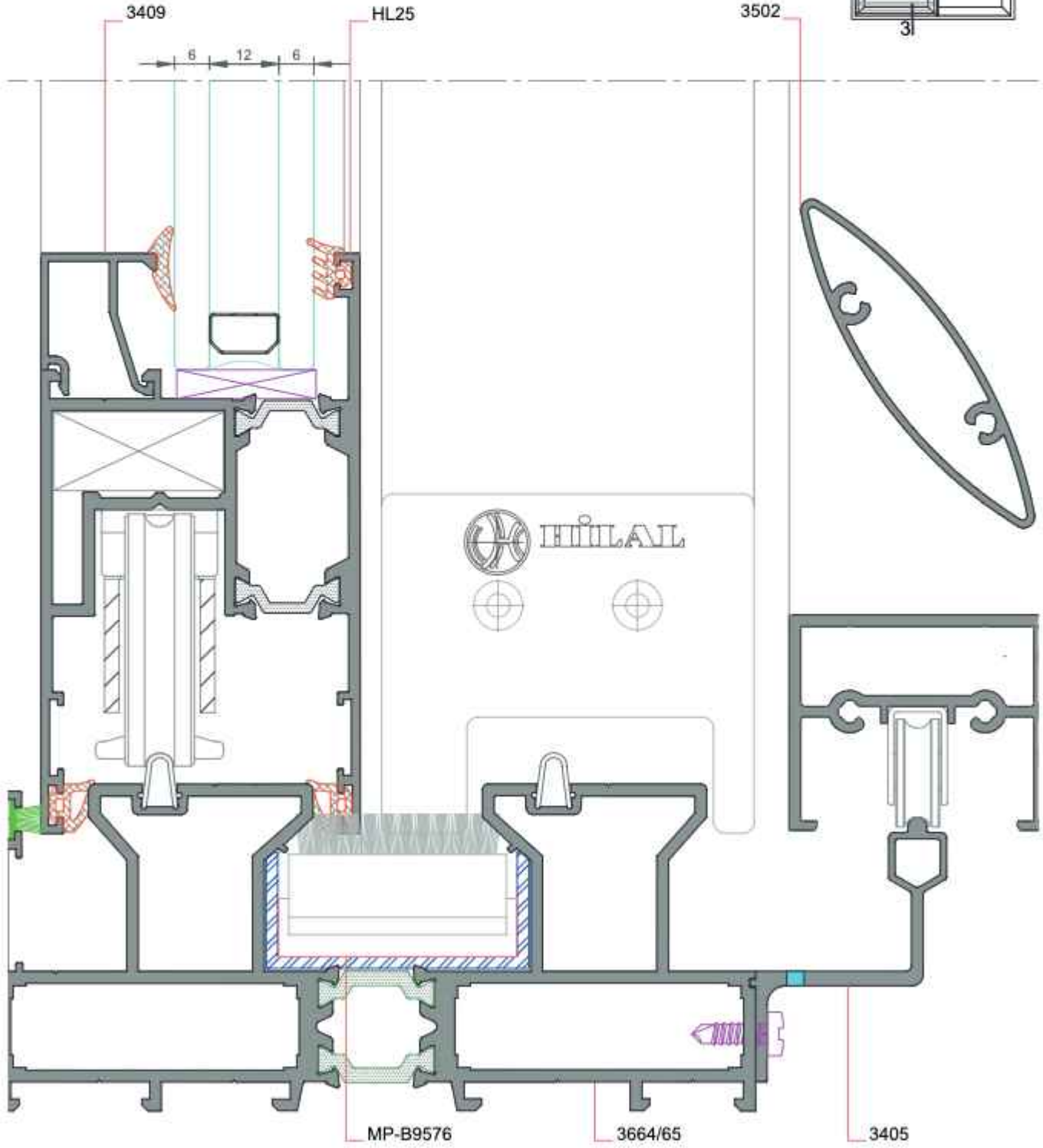

DETAY-4
ÖLÇEK:1/1

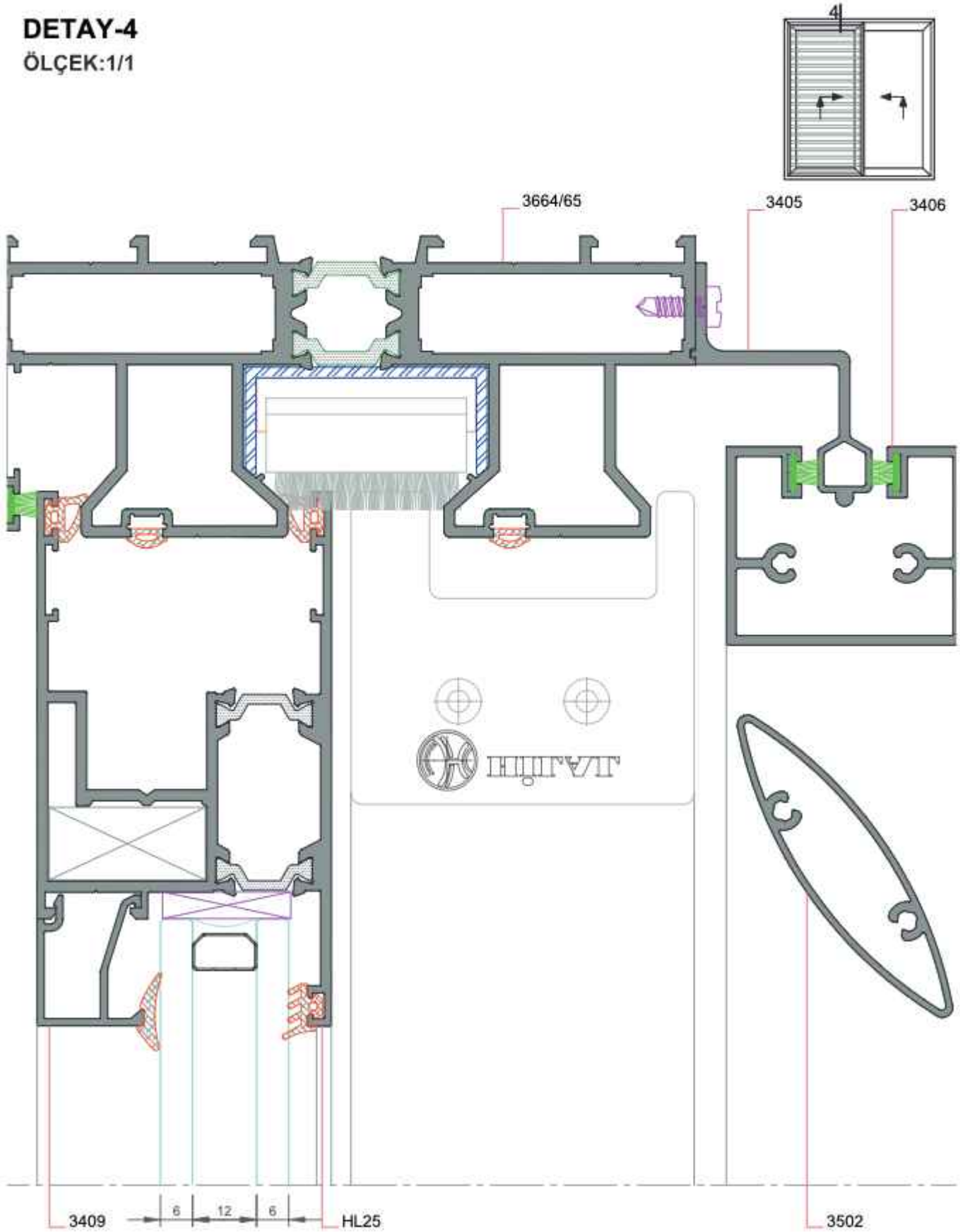

DETAY-1
ÖLÇEK:1/1

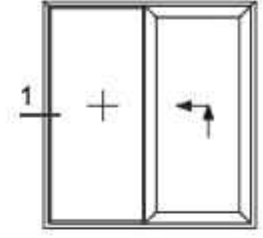

★ Yandaki profil birim ağırlıkları, bilgisayarla hesaplanmış teorik ağırlıklardır.

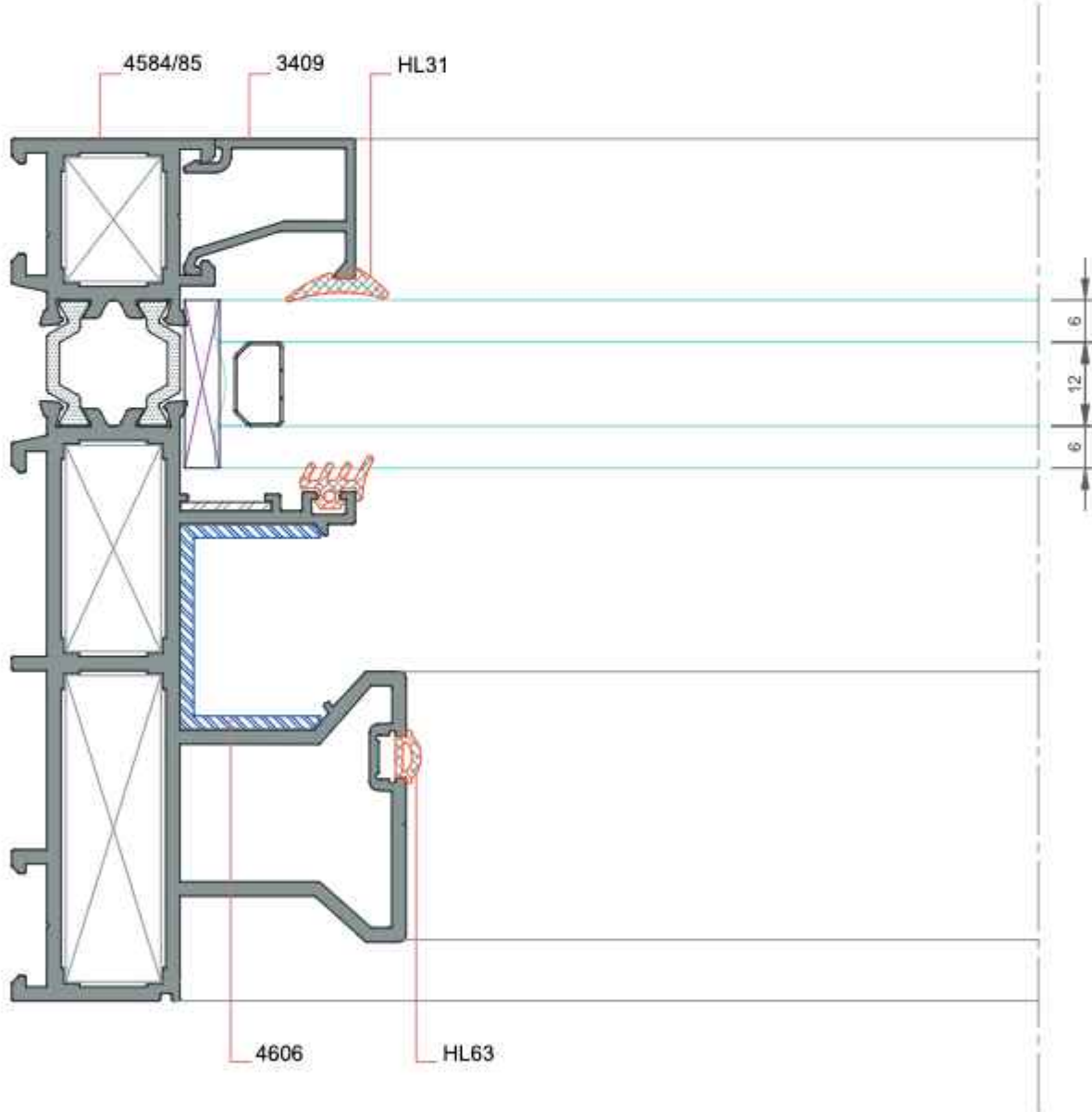

DETAY-2
ÖLÇEK:1/1

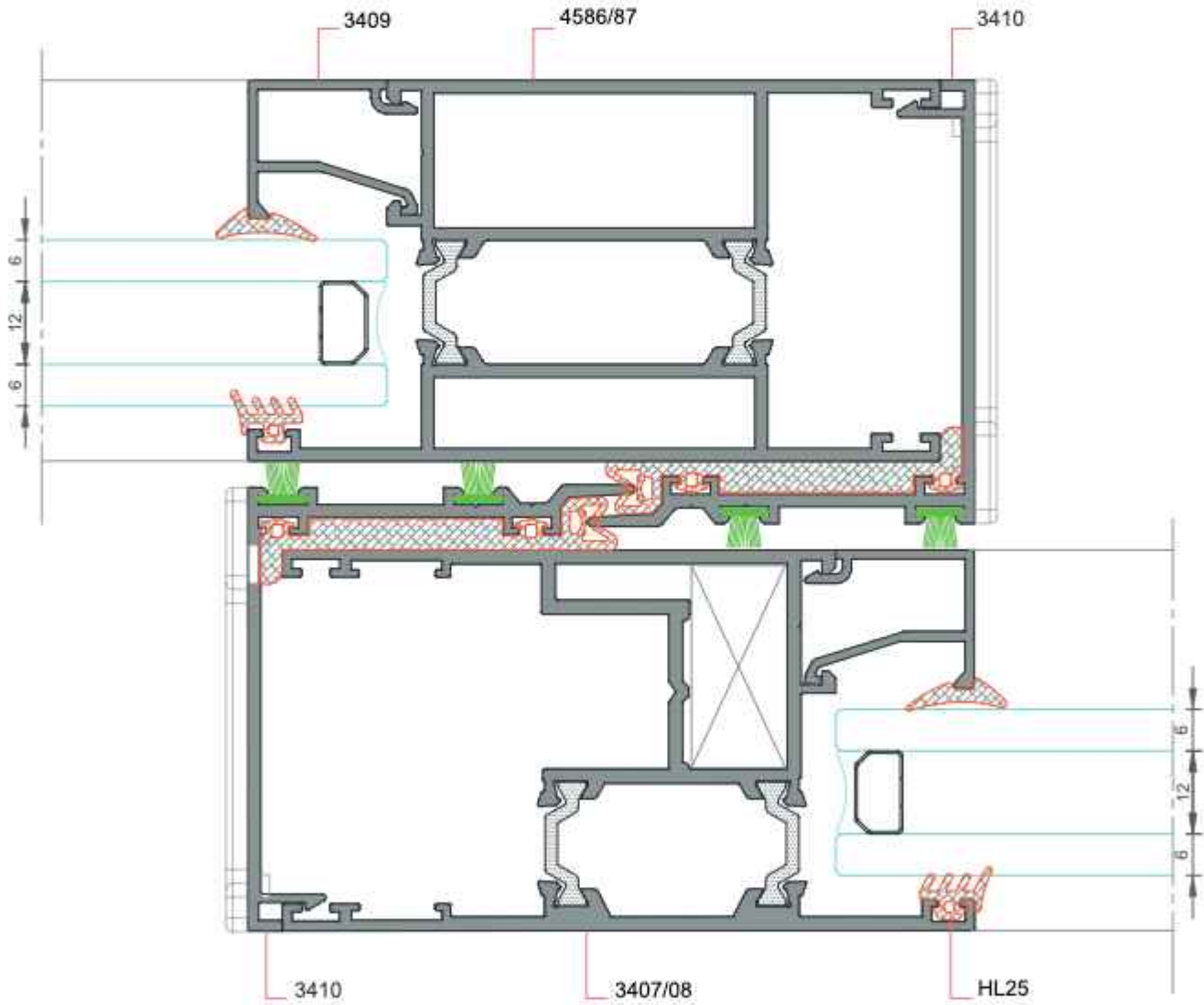
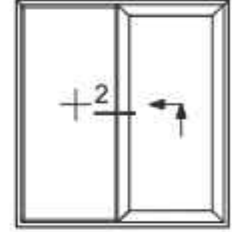

DETAY-3
ÖLÇEK:1/1

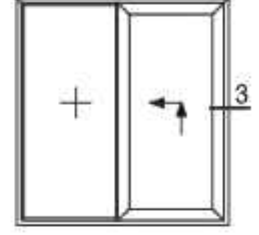

★ Yandaki profil birim ağırlıkları, bilgisayarla hesaplanmış teorik ağırlıklardır.

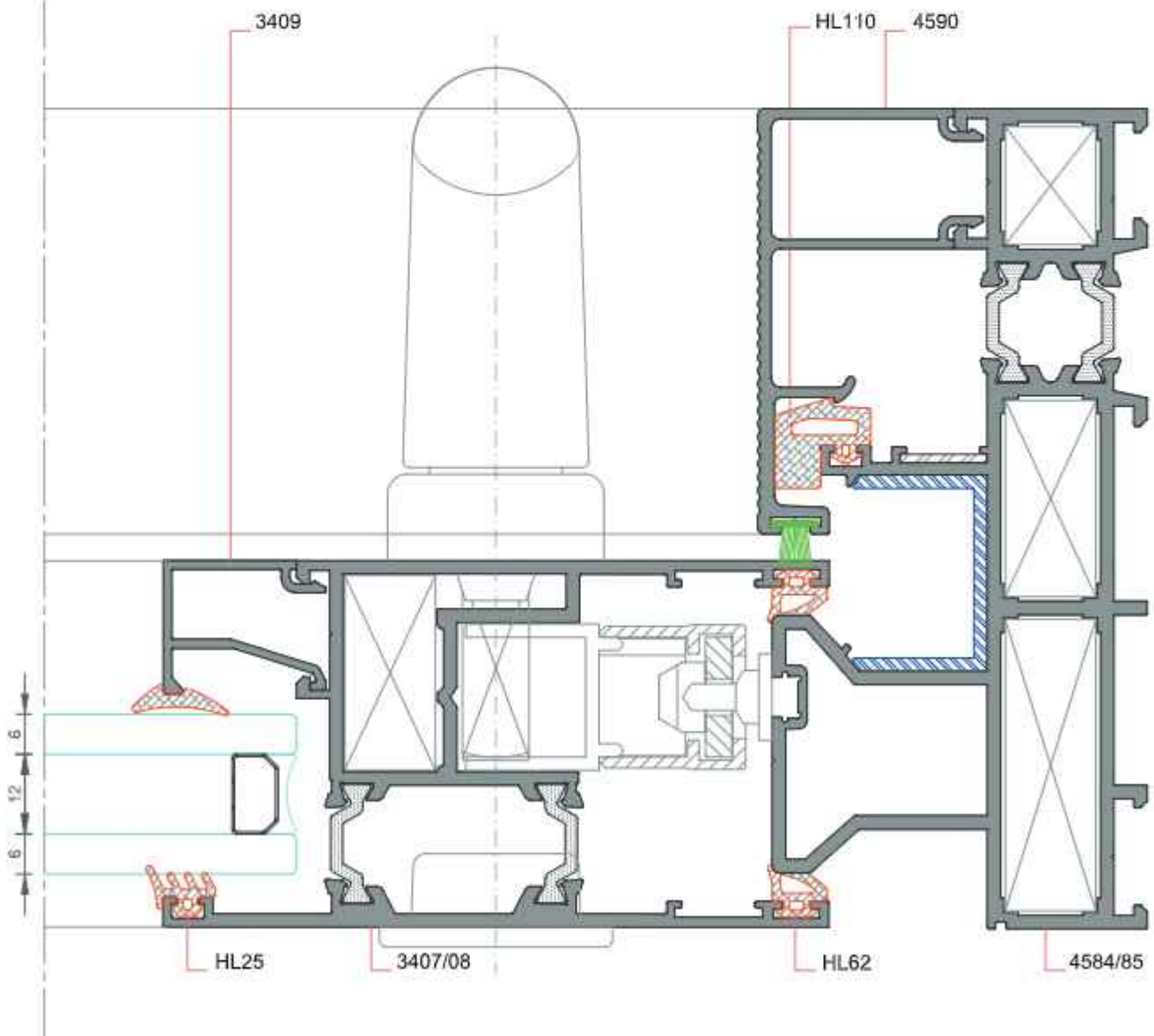

DETAY-4
ÖLÇEK:1/1

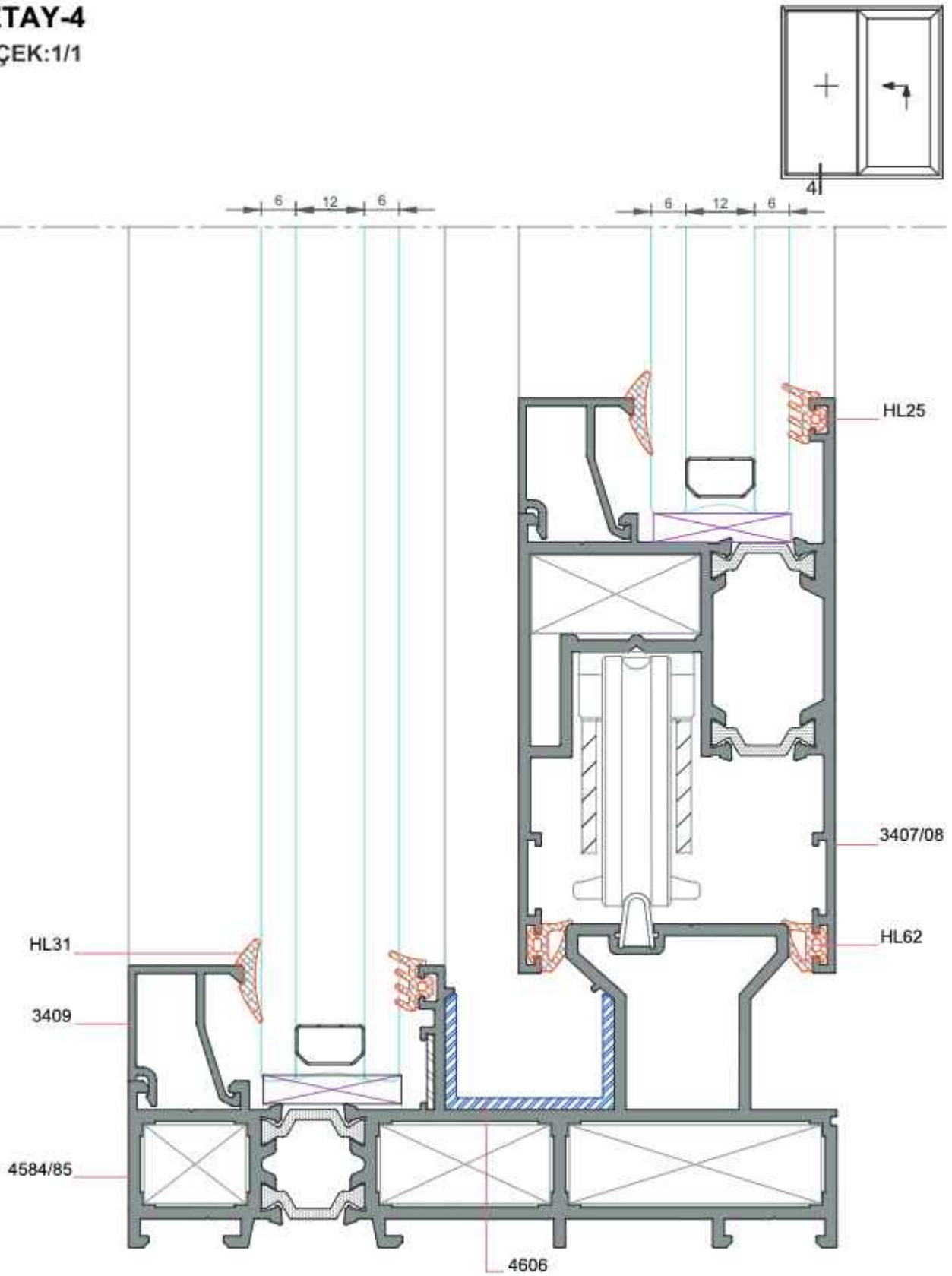

DETAY-5
ÖLÇEK:1/1



★ Yandaki profil birim ağırlıktan, bilgisayararda hesaplanmış teorik ağırlıklardır.

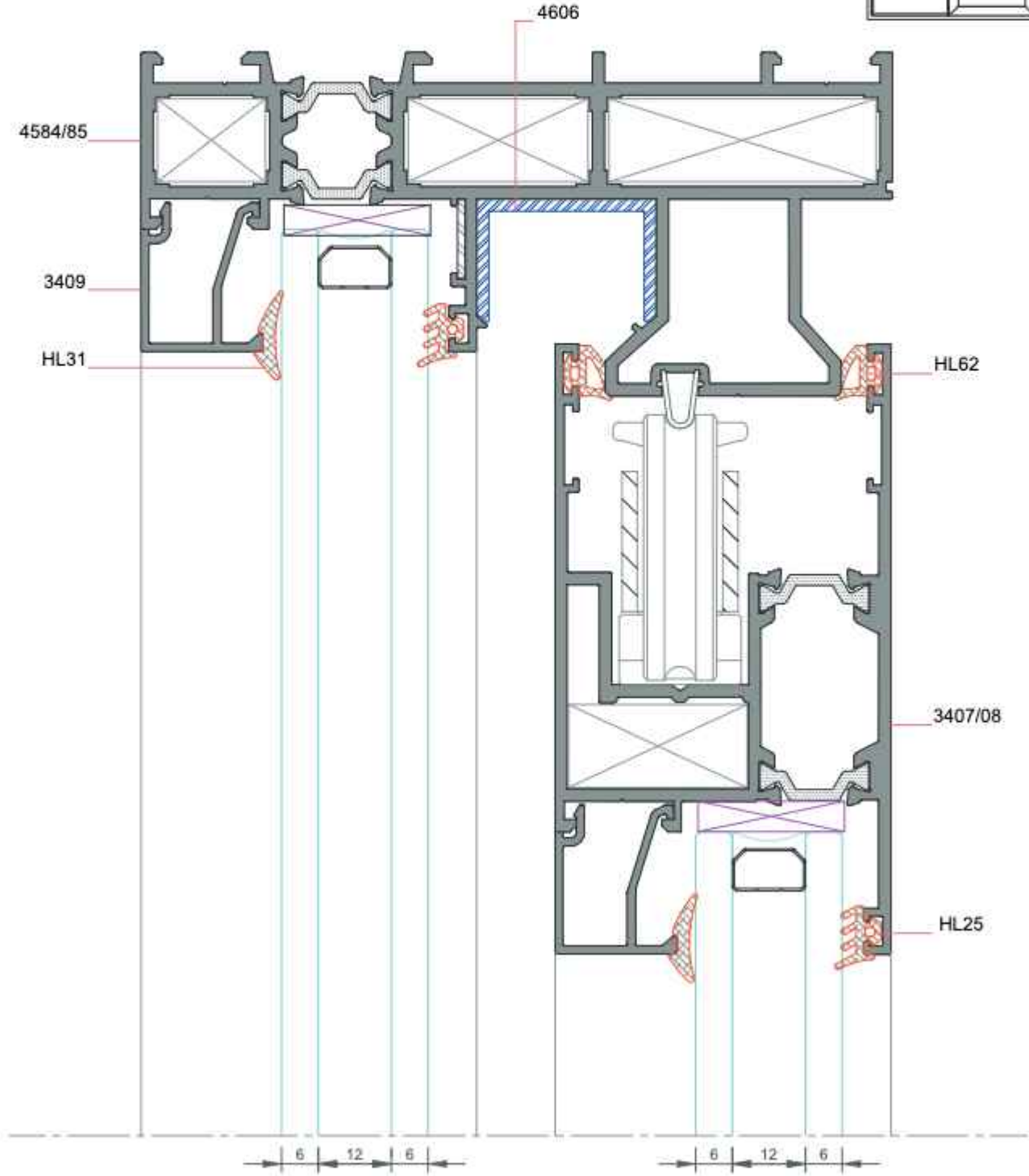

DETAY-6
ÖLÇEK:1/1

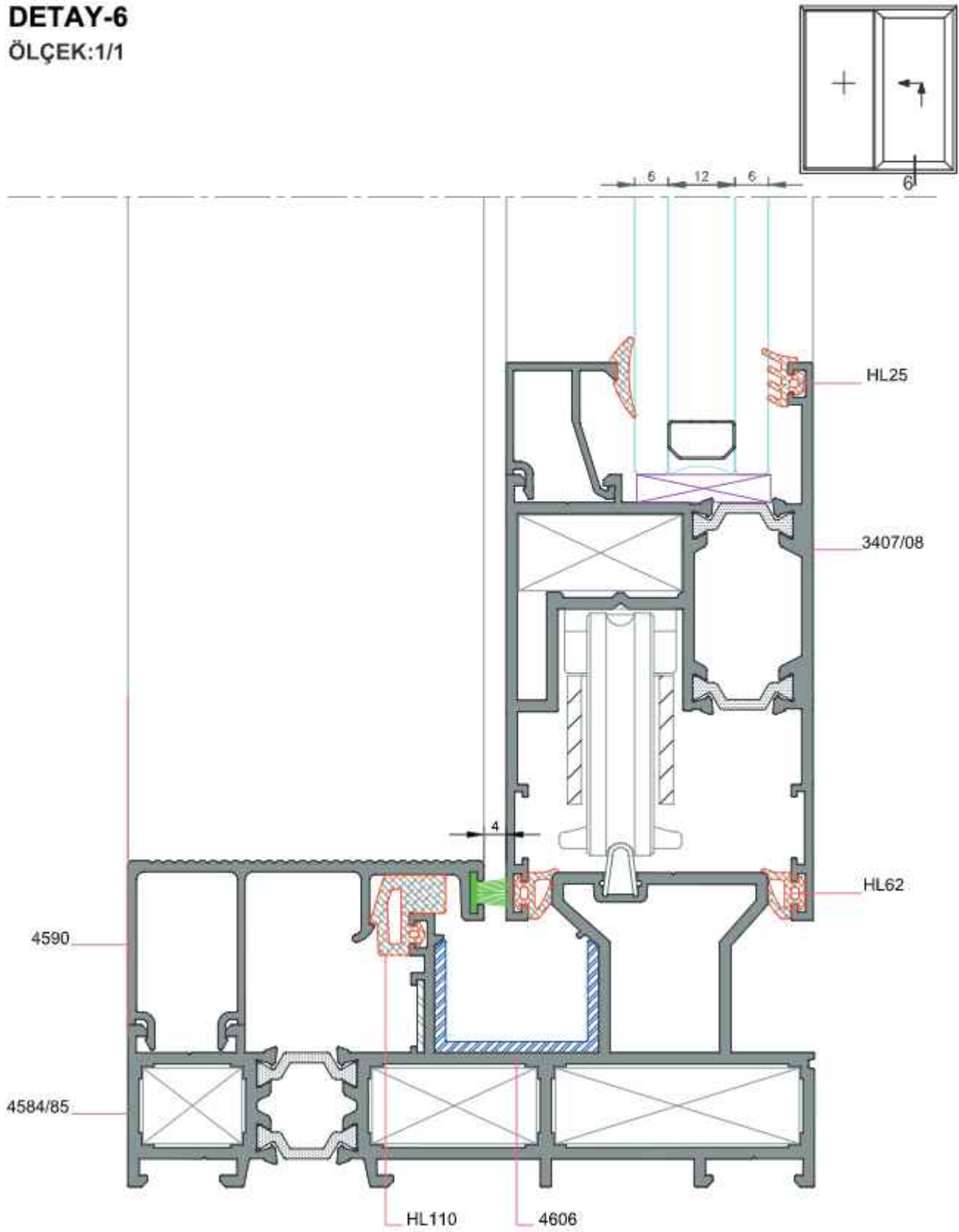

DETAY-7
ÖLÇEK:1/1

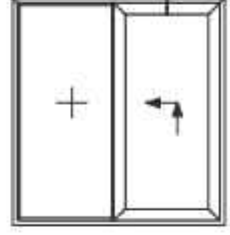

★ Yandaki profil birim ağırlıkları, bilgisayarla hesaplanmış teorik ağırlıklardır.

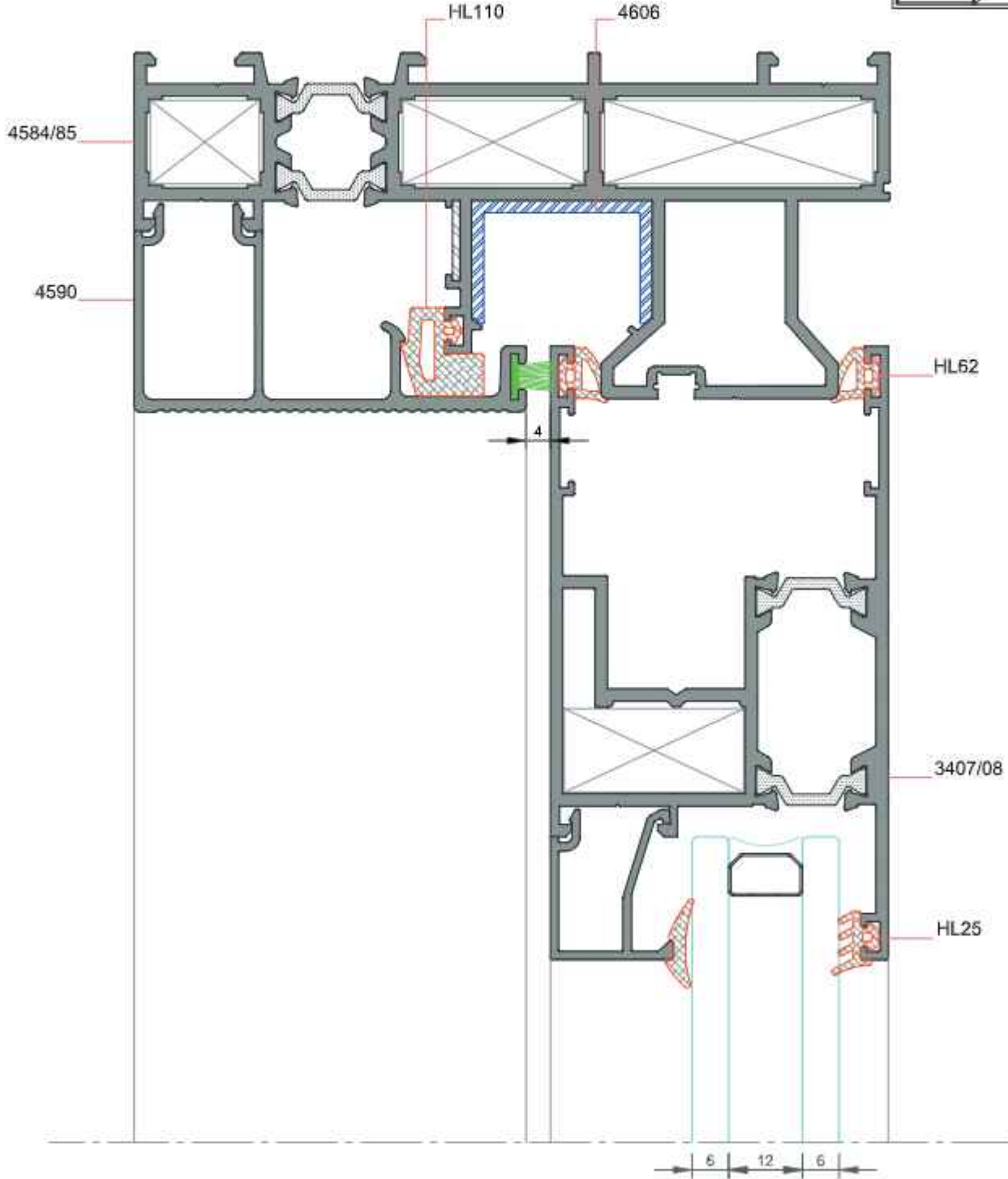

DETAY-1
ÖLÇEK:1/1

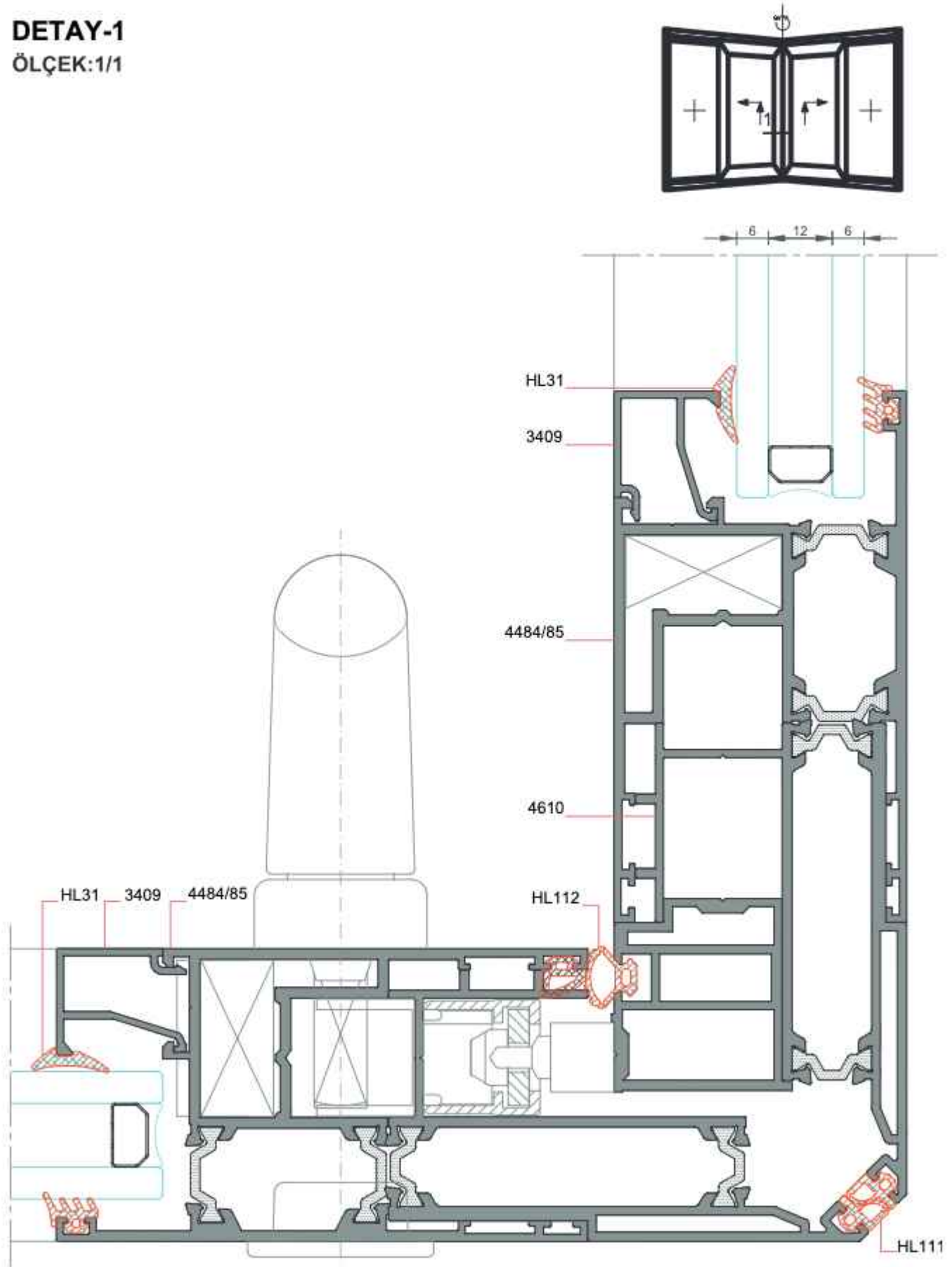

★ Yandaki profil birim ağırlıkları, bilgisayarda hesaplanmış teorik ağırlıklardır.

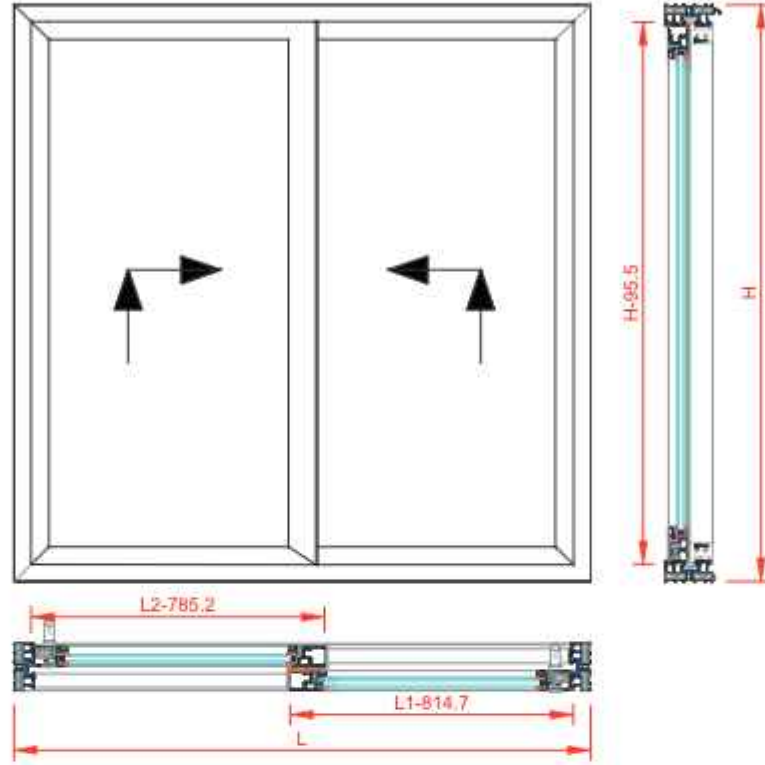

Profilin Adı	Profil Kesiti	Profil Kodu	Adet	Kesim Ölçüsü(mm)
Kasa Profili		3664/3665	2	L
			2	H
Kanat Profili		3407/3408	2	L1-814.7
			2	L2-785.2
			2	H-95.5
Cam Çıtası Profili	Kanat		2	
			2	
Cam Çıtası Profili	Kasa Orta Kayıt		2	
			2	

Bağlantı Elemanları	Kod	Birim	Miktar
Köşe Takozu (Kasa)	K3567 305	Adet	4
Köşe Takozu (Kanat)	K2892 415	Adet	4
Köşe Takozu (Kanat)	K2957 415	Adet	4

Cam (Açılır)	Adet	Cam Detayı	Kesim Ölçüsü (mm)
Diş Cam	2		
İç Cam			

Aksesuar	Adet	Detayı
Rulman	4	



PROFİL KATALOĐU









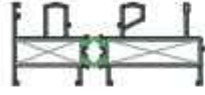

GXY H43 ISI YALITIMLI SÜRME SERİ

GXY H43 THERMAL INSULATED DOOR & WINDOW SYSTEMS



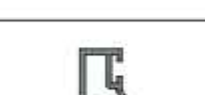

* Profil Ađırlıkları Teorik Olup Teslim Anındaki Ađırlık Geerlidir

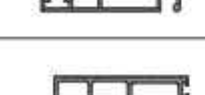
* *Weight of profiles are theoretical, net weight will valid at the time of delivery.*

★ Yandaki profil birim ağırlıkları, bilgisayarda hesaplanmış teorik ağırlıklardır.

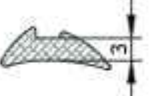
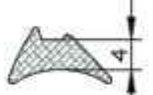

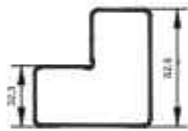
PROFİL KESİTİ	PROFİL KODU	PROFİL ADI	AĞIRLIK	ATALET MOMENTLERİ		SAYFA NO
				J_x (cm ⁴)	J_y (cm ⁴)	
	3859/3860	Kasa Profili	2,324 kg/m	124,53	17,68	
	3753/3754	Kasa Profili	2,141 kg/m	113,49	14,05	
	4500/4501	Sabit Isı Yalıtımlı Profili	1,618 kg/m	78,44	3,99	
	4923/4924	Sabit Isı Yalıtımlı Kasa Profili	2,014 kg/m	108,71	11,15	
	3755/3756	Kanat Profili	1,463 kg/m	27,01	13,41	
	4925/4926	Sabit Isı Yalıtım Profili	1,738 kg/m	28,68	15,30	
	4927/4928	Sabit Isı Yalıtım Orta Kayıt Profili	1,049 kg/m	8,11	4,76	
	4502	Cam Çıtası	0,455 kg/m	
	3752	Cam Çıtası	0,183 kg/m	
	3183	Cam Çıtası	0,377 kg/m	
	3760	Kenet Kapak Profili	0,363 kg/m	
	1843	Sineklik Profili	0,359 kg/m	
	4929	Basamak Çıtası Profili	0,637 kg/m	
	3091	Köşe Takoğu	4,307 kg/m	

★ Yandaki profil birim ağırlıkları, bilgisayarda hesaplanmış teorik ağırlıklardır.

AKSESUAR KESİTİ	AKSESUAR KODU	AKSESUAR ADI	AĞIRLIK	PAKETLEME	SAYFA NO
	HL31(2mm)	Kama Fitili	40 gr/m	15kg/ 375 m	
	HL04(3mm)	Kama Fitili	60 gr/m	15 kg/ 250 m	
	HL07(4mm)	Kama Fitili	63 gr/m	15 kg/ 238 m	
	HL02(4.5mm)	Kama Fitili	70 gr/m	15 kg/ 175 m	
	HL70	Dış Cam Fitili	44 gr/m	15 kg/ 340 m	
	HL116	Basamak Çıtası Altı Fitili	70 gr/m	15 kg/ 214 m	
	MP56-04/3-1	Sürme Kanat Onbaşı (32,3x62,6)	...	100 ad/paket	
	MP-B9728	Havuz Plastik	133gr/m	6 m/boy	
	MP-B9727	Kanca Bariyeri	175gr/m	6 m/boy	
 Dış Cam Ray Akses 1 pkt 500 ad: 11,39 kg	MP27-48	Zamak Sürme Karşılık	11,05 kg	500 ad/paket	
 HA28-08/4 HE-9500 HAVUZ KOLU (DİREK) 21 x 40 x 100 x 100 1000	MP28-08/4	Sürme İspanyolet (30 cm, 40 cm, 60 cm, 80 cm, 100 cm, 120 cm, 140 cm, 160 cm, 180 cm, 200 cm)	
	HE-9500	Havuz Kol	

★ Yandaki profil birim ağırlıkları, bilgisayarda hesaplanmış teorik ağırlıklardır.

AKSESUAR KESİTİ	AKSESUAR KODU	AKSESUAR ADI	AĞIRLIK	PAKETLEME	SAYFA NO
HA52-5018 SÜRME SİNEKLİK HAVUZ KOL 100 AD 	MP52-5018	Sürme Sineklik Havuz Kol	...	100 ad/paket	
	03360V	Sürme Kol	...	1 ad/paket	
HA33-07/9 MİSİR SÜRME RULMANI 100 AD 	MP33-07/9-928	Çiftli Sürme Rulman	
 HA52-5060 SÜRME SİNEKLİK RULMANI 100 AD	MP52-5060	Sürme Sineklik Rulmanı	...	100 ad/paket	
	MP42-36/1	Tozluk Fiteli	
 MP29-01/H6 ALÜMİNYUM PENCERE KOLU 50 AD	MP29-01/H6	Alüminyum Pencere Kolu	...	50 ad/paket	
 HE-9100 SÜRME KIL FİTEL 100 AD	HE-9100	Sürme Kıl Fitel (067*550)	
 MP52-5007 SİNEKLİK KÖŞE TAKOĞU 100 AD	MP52-5007	Sineklik Köşe Takoğu	...	100 ad/paket	
 MP57-06/MP57-07-5025 SİNEKLİK FİTELİ 100 m	MP57-06/ MP57-07-5025	Sineklik Fiteli	...	100 m	
 MP54-9160 SİNEKLİK TÜL 48 m2	MP54-9160	Sineklik Tül	...	48 m2	
	MP-B9749	İspanyolet Besleme Kiti	300 gr/m	6 m/boy	

AKSESUAR KESİTİ	AKSESUAR KODU	AKSESUAR ADI	AĞIRLIK	PAKETLEME	SAYFA NO
	MP32-14/2	Anahtarlı Tetik Kol	...	100 ad/1 Koli	
	HE-9001/1	Stoper	

★ Yandaki profil birim ağırlıkları, bilgisayarda hesaplanmış teorik ağırlıklardır.

3859/3860
Isı Yalıtımlı Kasa Profili
2,324 kg/m
Jx=124,53 cm ⁴ Jy=17,68 cm ⁴

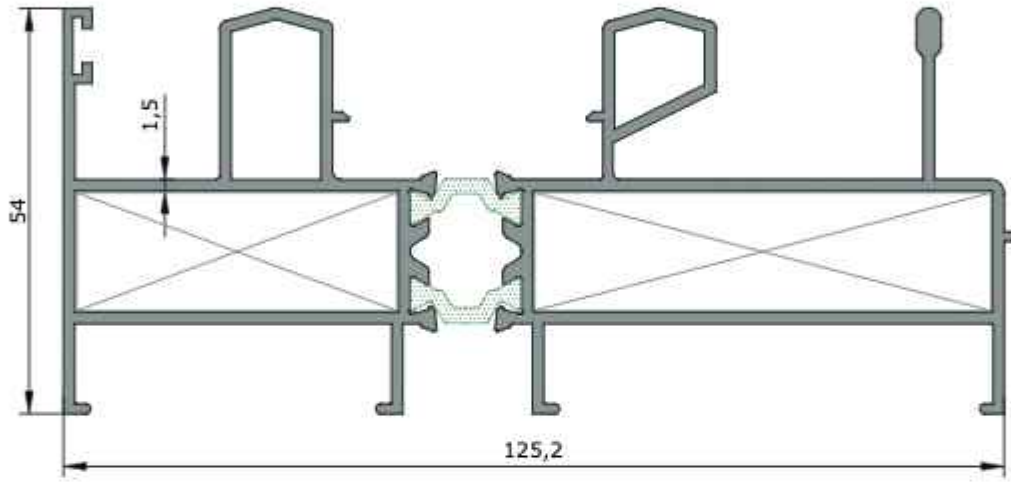

3753/3754
Isı Yalıtımlı Kasa Profili
2,141 kg/m
Jx=113,49 cm ⁴ Jy=14,05 cm ⁴

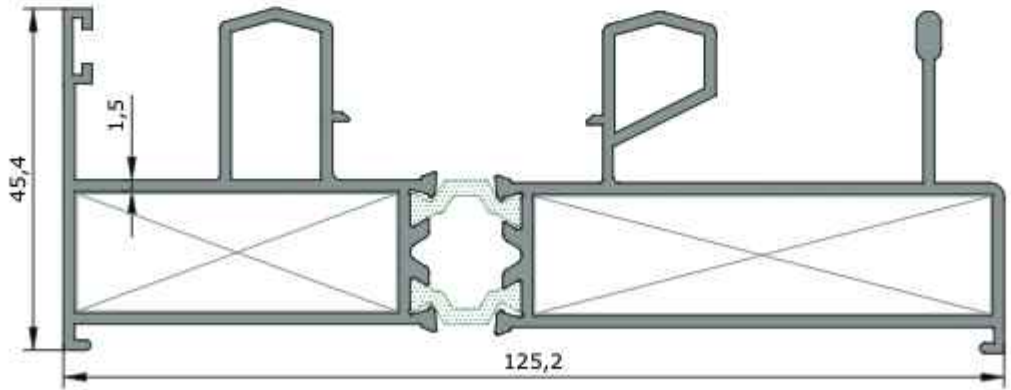

★ Yandaki profil birim ağırlıkları, bilgisayarda hesaplanmış teorik ağırlıklardır.

SÜRME UYGULAMA TİPLERİ

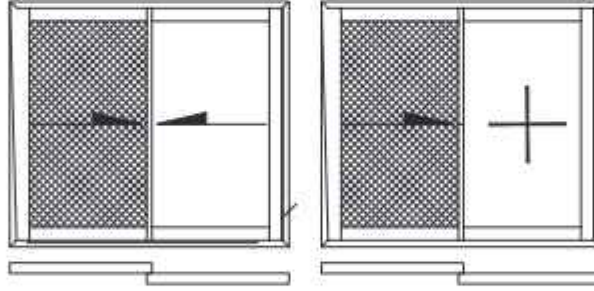
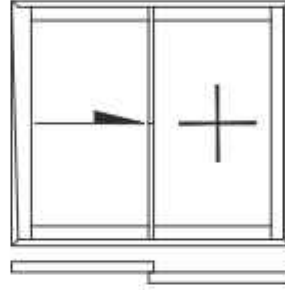

★ Yandaki profil birim ağırlıkları, bilgisayarda hesaplanmış teorik ağırlıklardır.

★ Yandaki profil birim ağırlıkları, bilgisayarda hesaplanmış teorik ağırlıklardır.

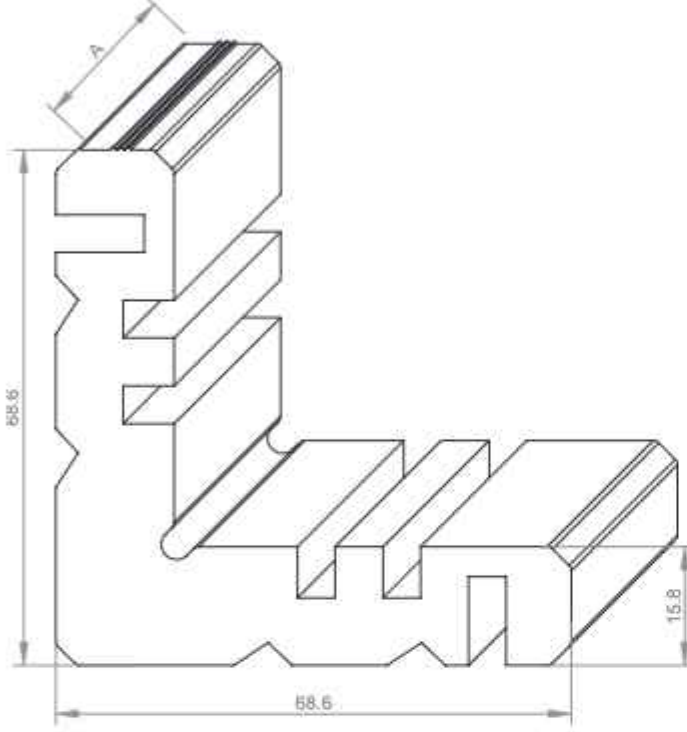

3091

Köşe Takozu

4,307 kg/m

Aksesuar Kodu	Profil Kodu	Kesim Ölçüsü A(mm)
K3091 158	3755/3756	15.8
K3091 426	3859/3860	42.6
K3091 607	3859/3860	60.7
K3091 426	3753/3754	42.6
K3091 607	3753/3754	60.7
K3091 177	4500/4501	17.7
K3091 353	4500/4501	35.3
K3091 567	4923/4924	56.7
K3091 457	4923/4924	45.7

SÜRME UYGULAMA TİPLERİ

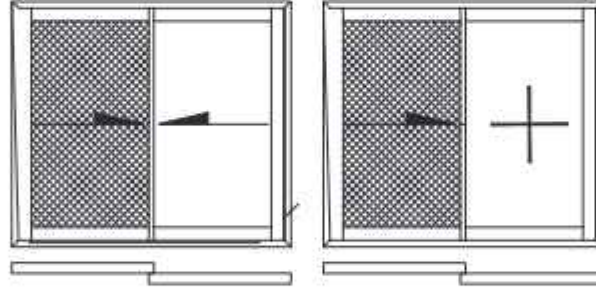
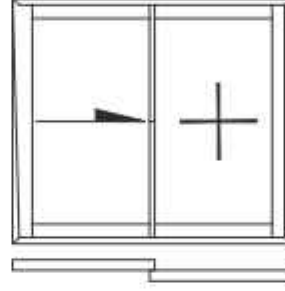

★ Yandaki profil birim ağırlıkları, bilgisayarda hesaplanmış teorik ağırlıklardır.

DETAY-1

ÖLÇEK:1/1

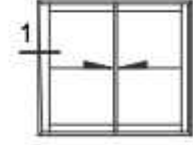

★ Yandaki profil birim ağırlıkları, bilgisayarda hesaplanmış teorik ağırlıklardır.

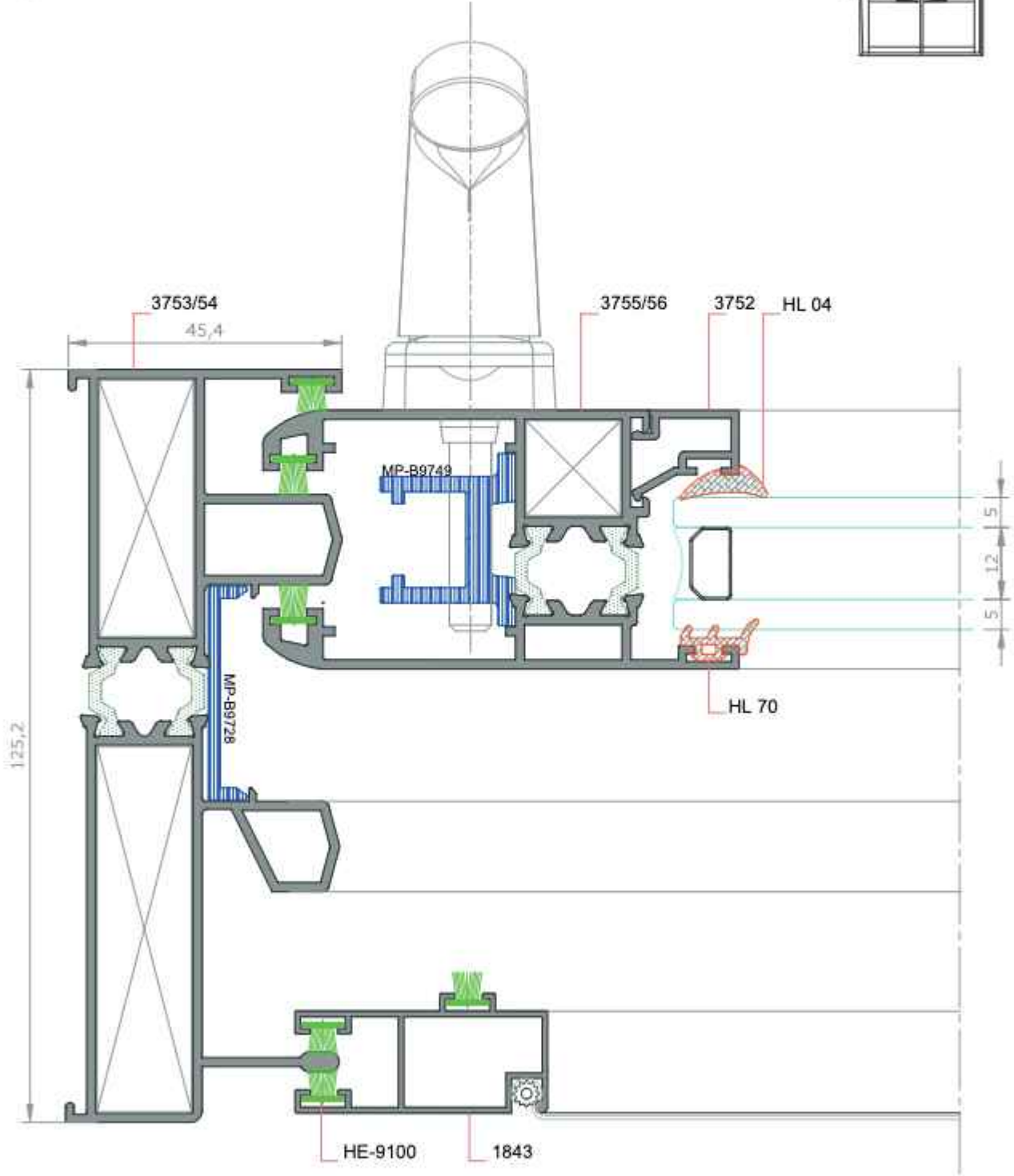

DETAY-2

ÖLÇEK:1/1

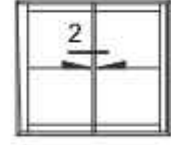

★ Yandaki profil birim ağırlıkları, bilgisayarda hesaplanmış teorik ağırlıklardır.

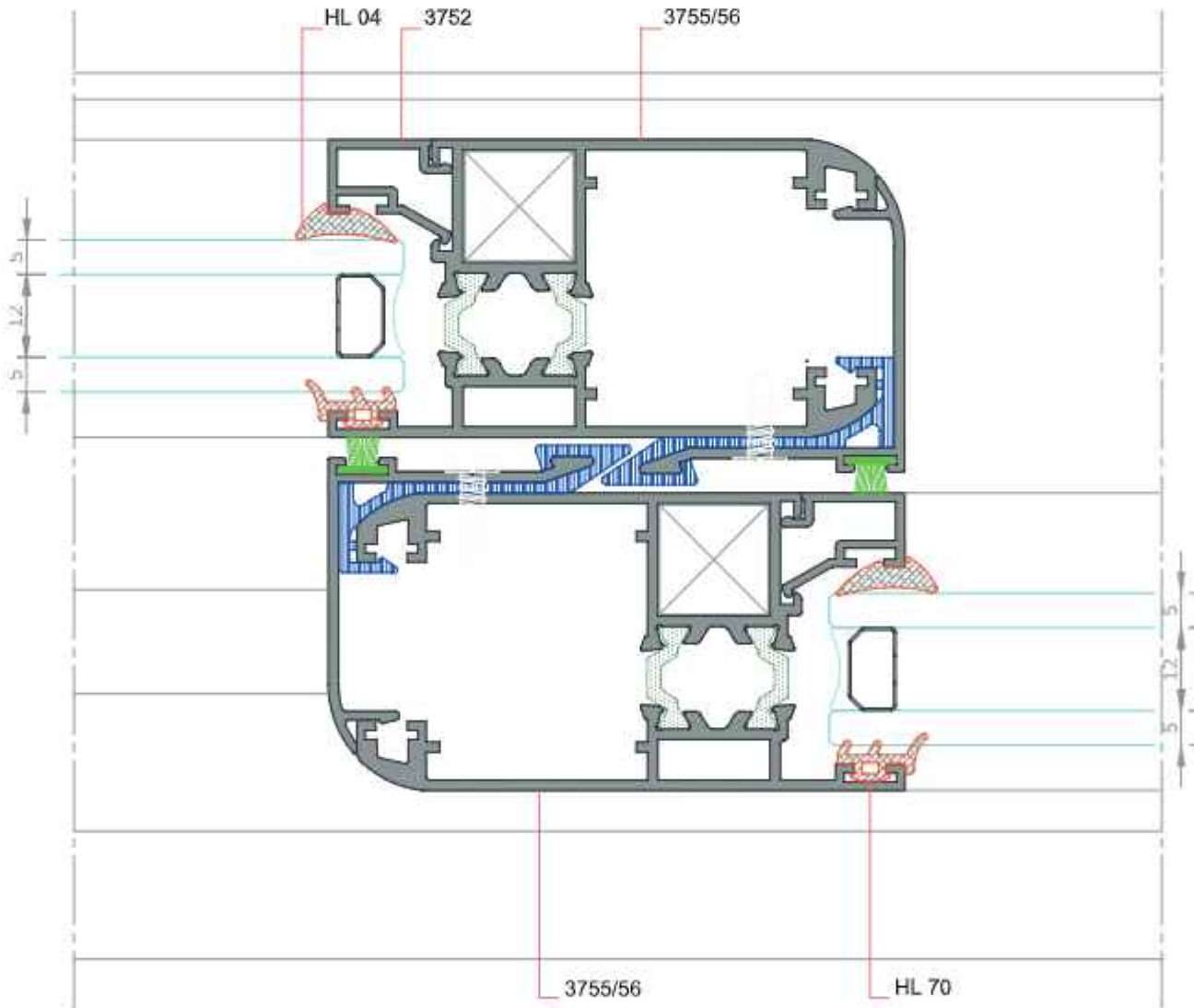

DETAY-3

ÖLÇEK:1/1

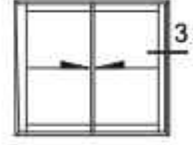

★ Yandaki profil birim ağırlıkları, bilgisayarla hesaplanmış teorik ağırlıklardır.

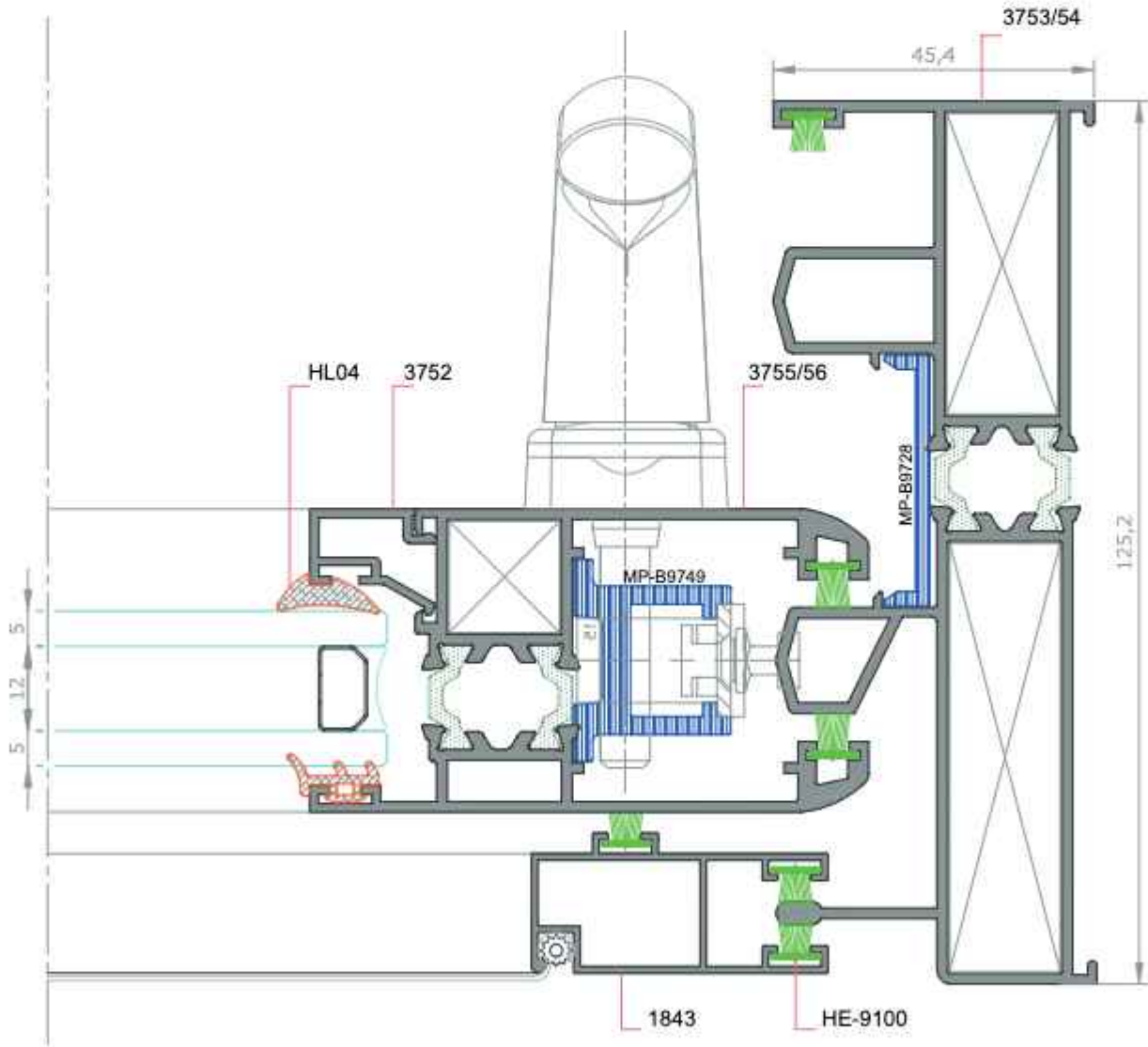

DETAY-4

ÖLÇEK:1/1

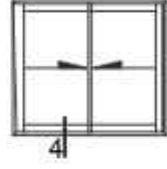

★ Yandaki profil birim ağırlıkları, bilgisayarla hesaplanmış teorik ağırlıklardır.



DETAY-1
ÖLÇEK: 1/1

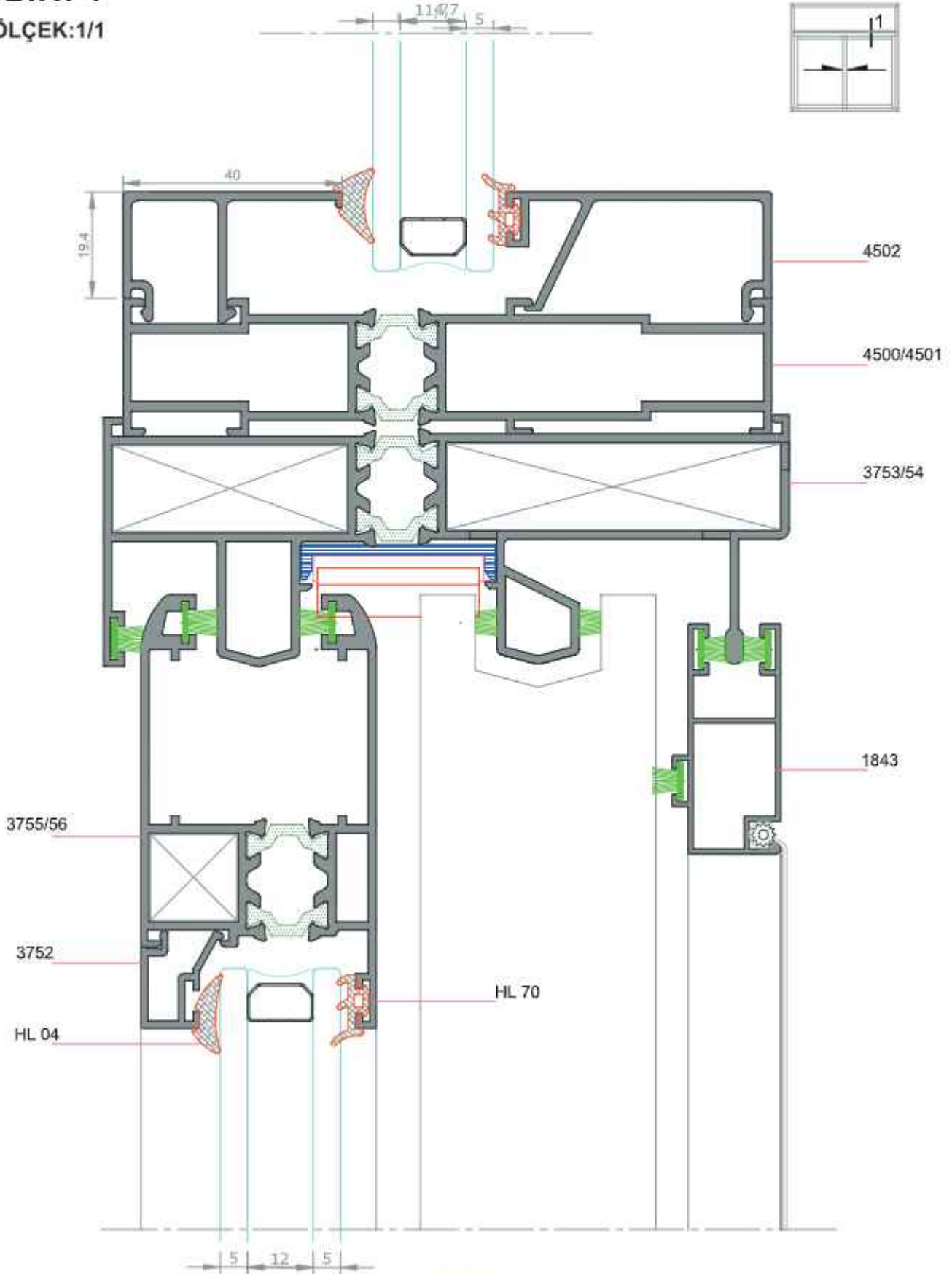

★ Yandaki profil birim ağırlıkları, bilgisayarla hesaplanmış teorik ağırlıklardır.

DETAY-1
ÖLÇEK:1/1

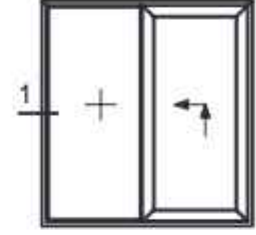

★ Yandaki profil birim ağırlıkları, bilgisayarla hesaplanmış teorik ağırlıklardır.

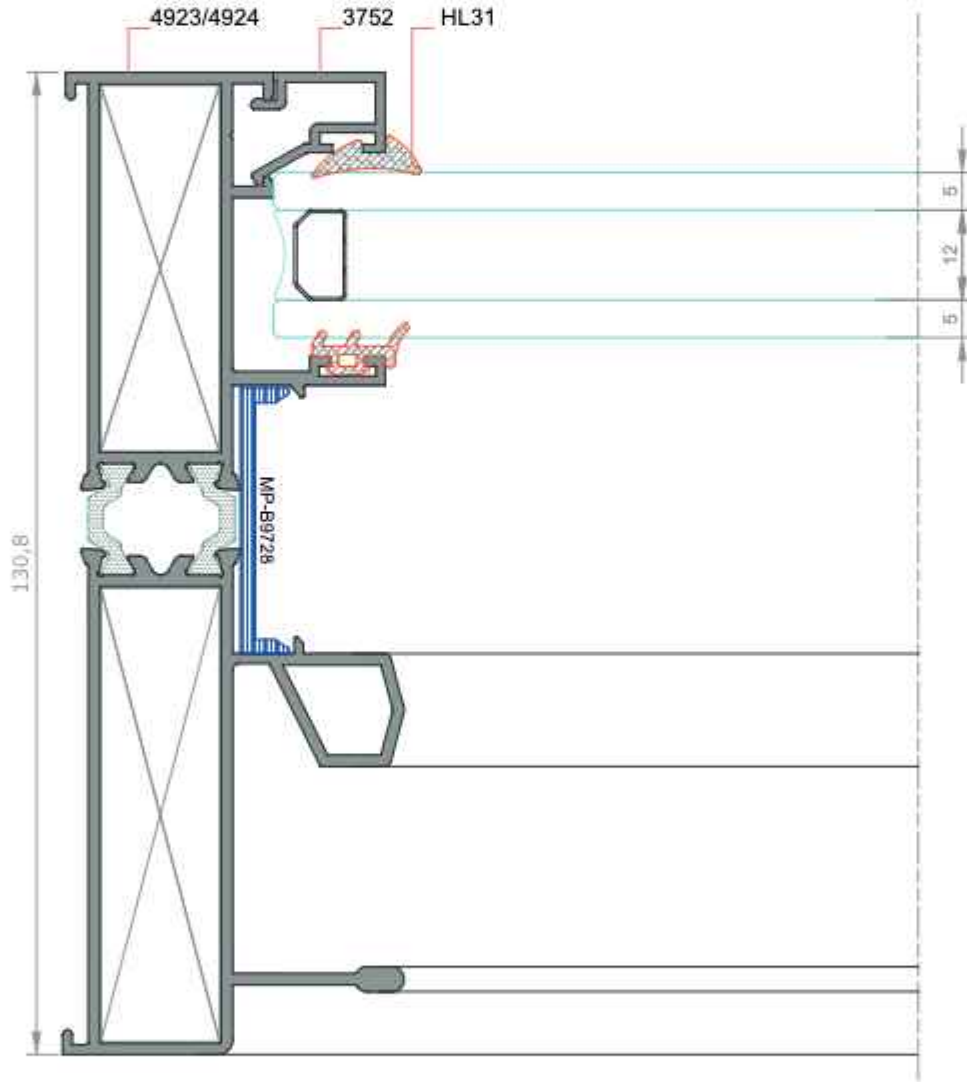

DETAY-2
ÖLÇEK:1/1

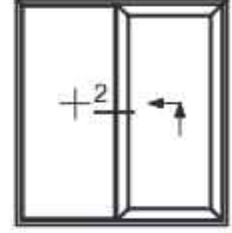

★ Yandaki profil birim ağırlıkları, bilgisayarda hesaplanmış teorik ağırlıklardır.

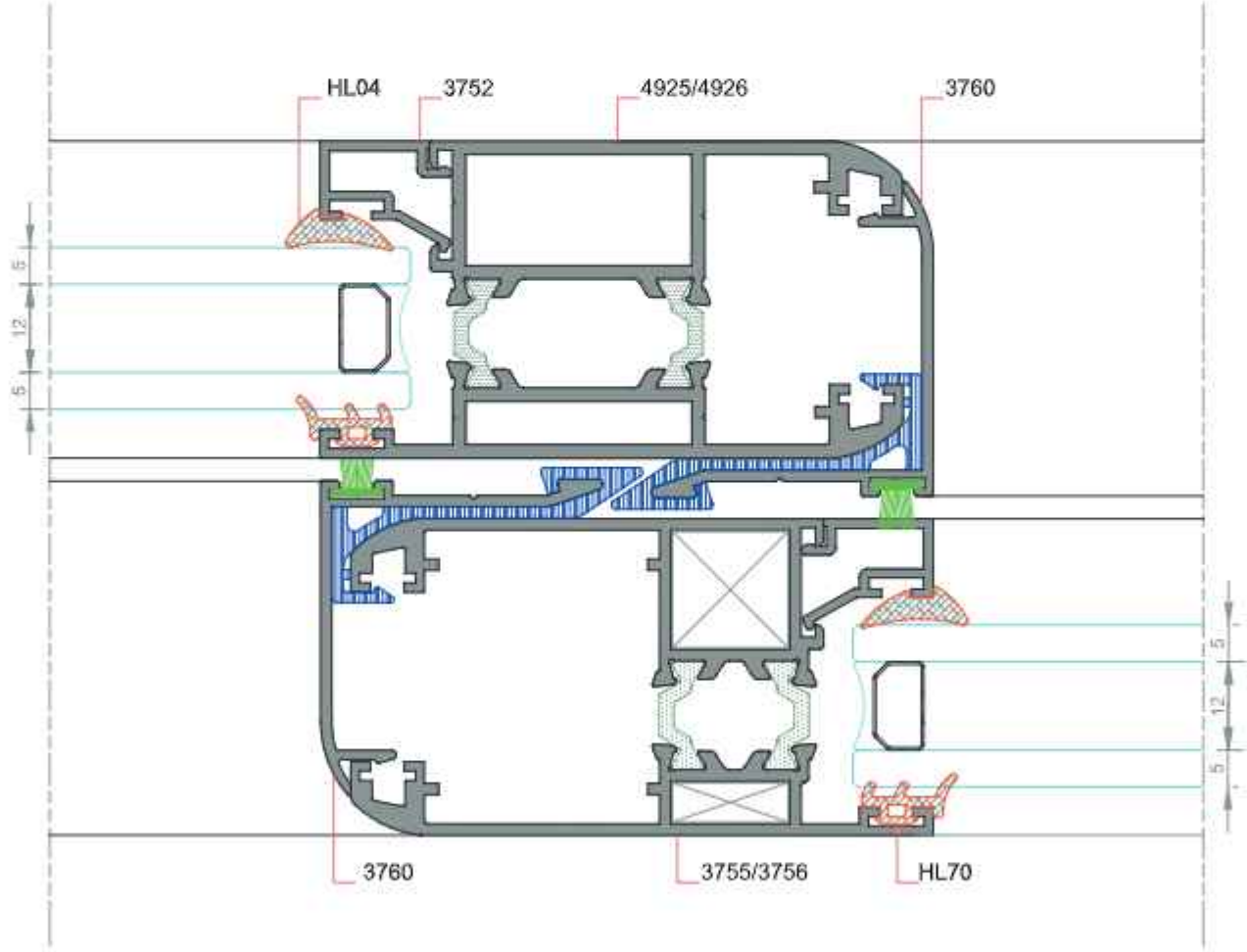

DETAY-3
ÖLÇEK:1/1

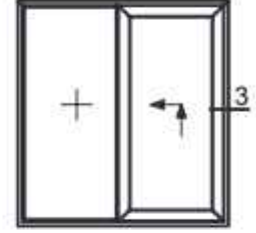

★ Yandaki profil birim ağırlıkları, bilgisayarla hesaplanmış teorik ağırlıklardır.

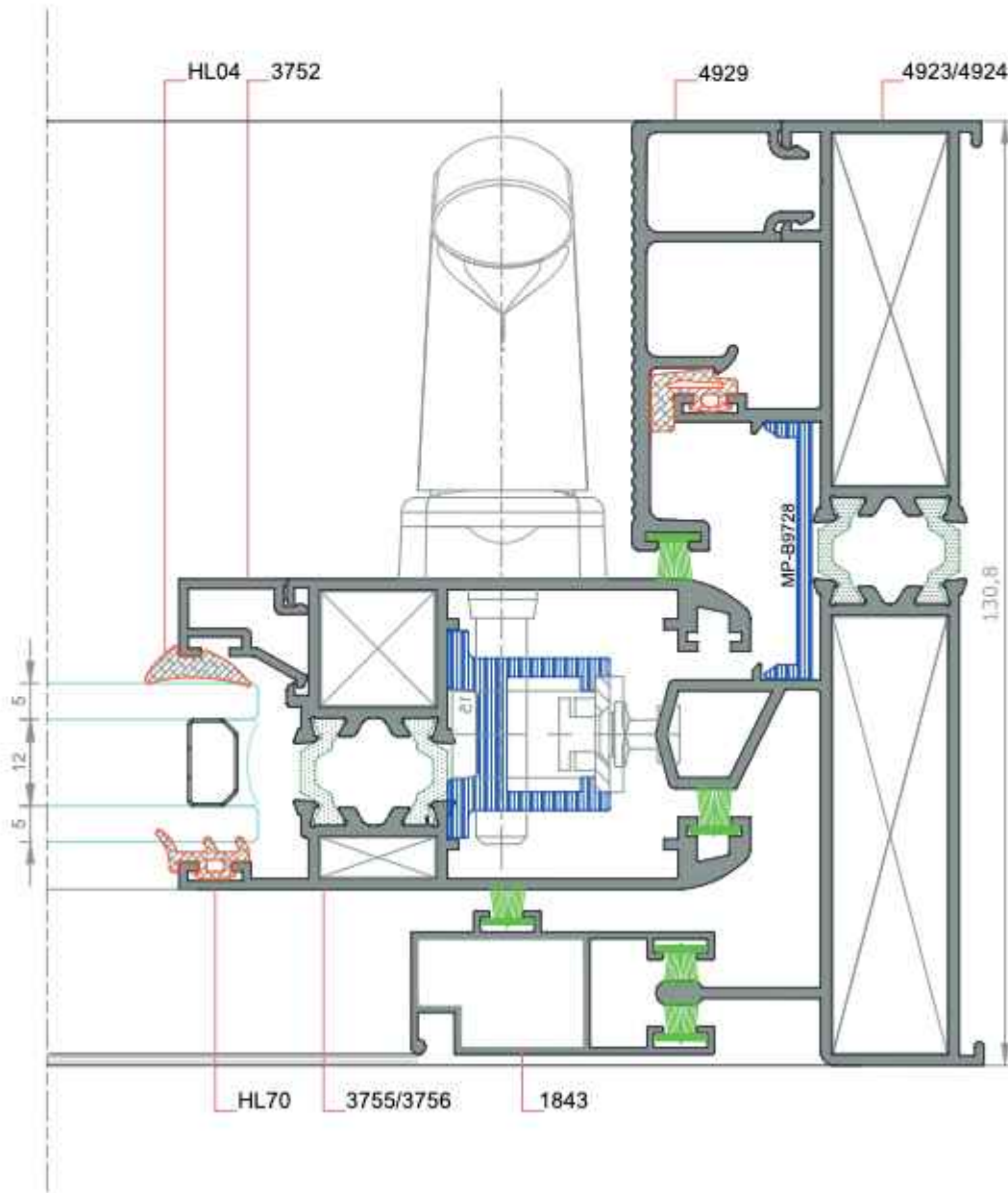

DETAY-4
ÖLÇEK:1/1

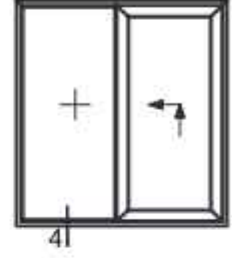

★ Yandaki profil birim ağırlıktan, bilgisayarla hesaplanmış teorik ağırlıklardır.

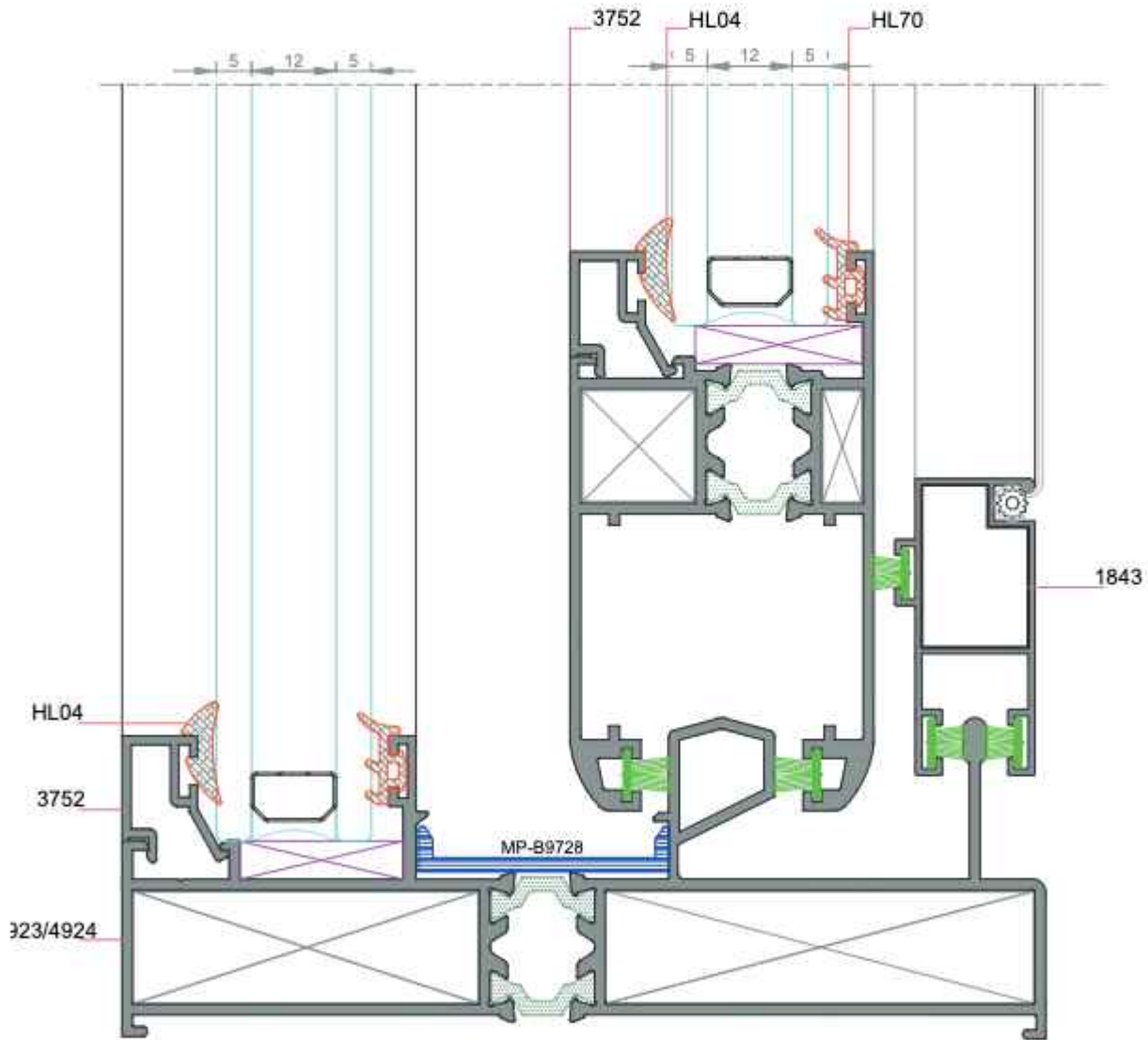

DETAY-5
ÖLÇEK:1/1

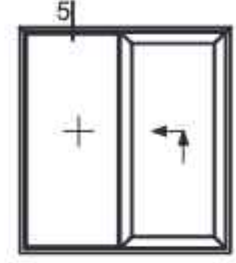

★ Yandaki profil birim ağırlıkları, bilgisayarda hesaplanmış teorik ağırlıklardır.

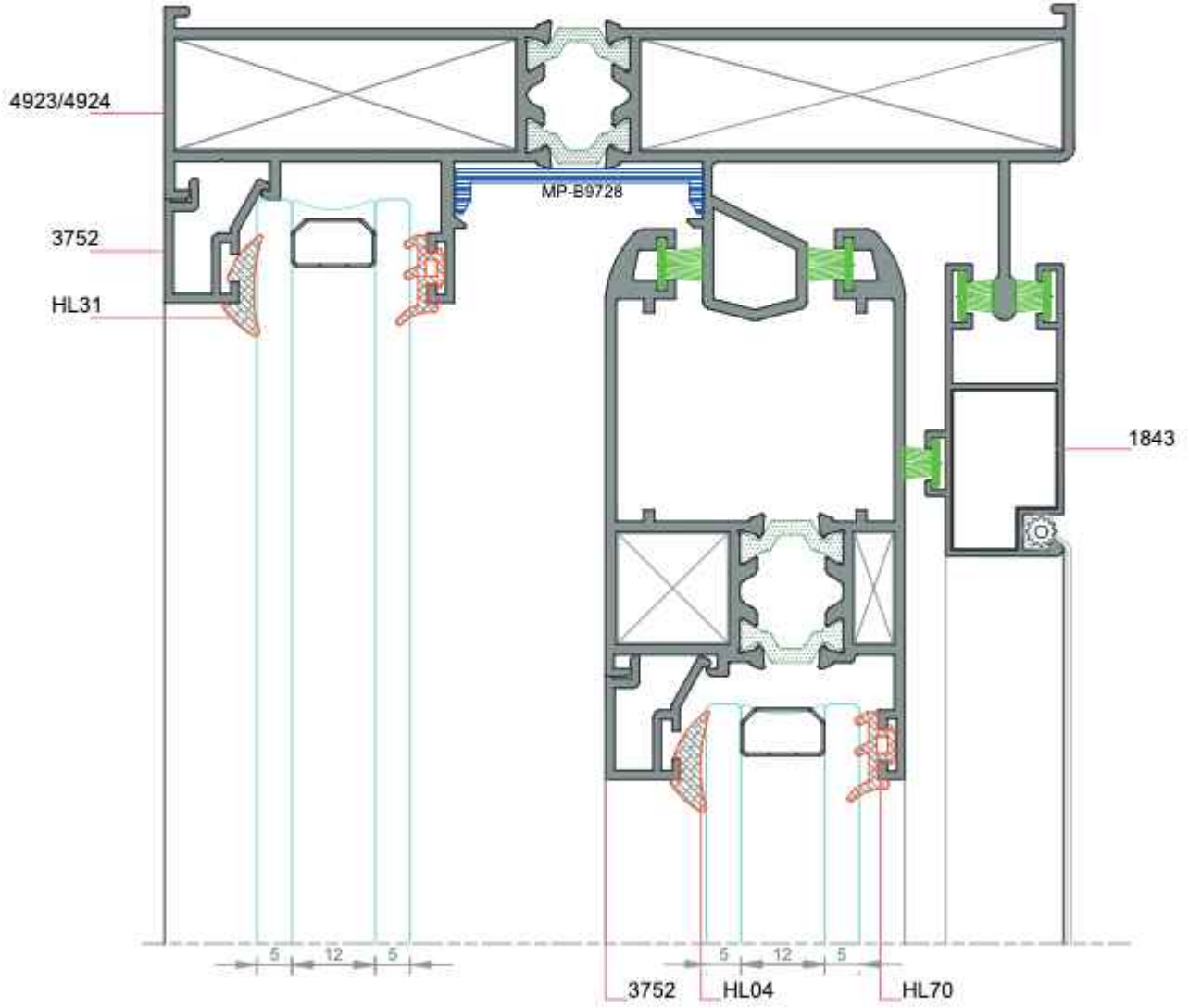

DETAY-6
ÖLÇEK:1/1

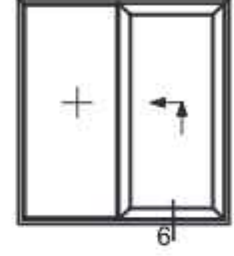

★ Yandaki profil birim ağırlıkları, bilgisayarla hesaplanmış teorik ağırlıklardır.



DETAY-7
ÖLÇEK:1/1

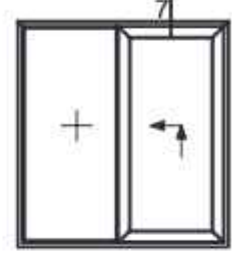

★ Yandaki profil birim ağırlıkları, bilgisayarda hesaplanmış teorik ağırlıklardır.

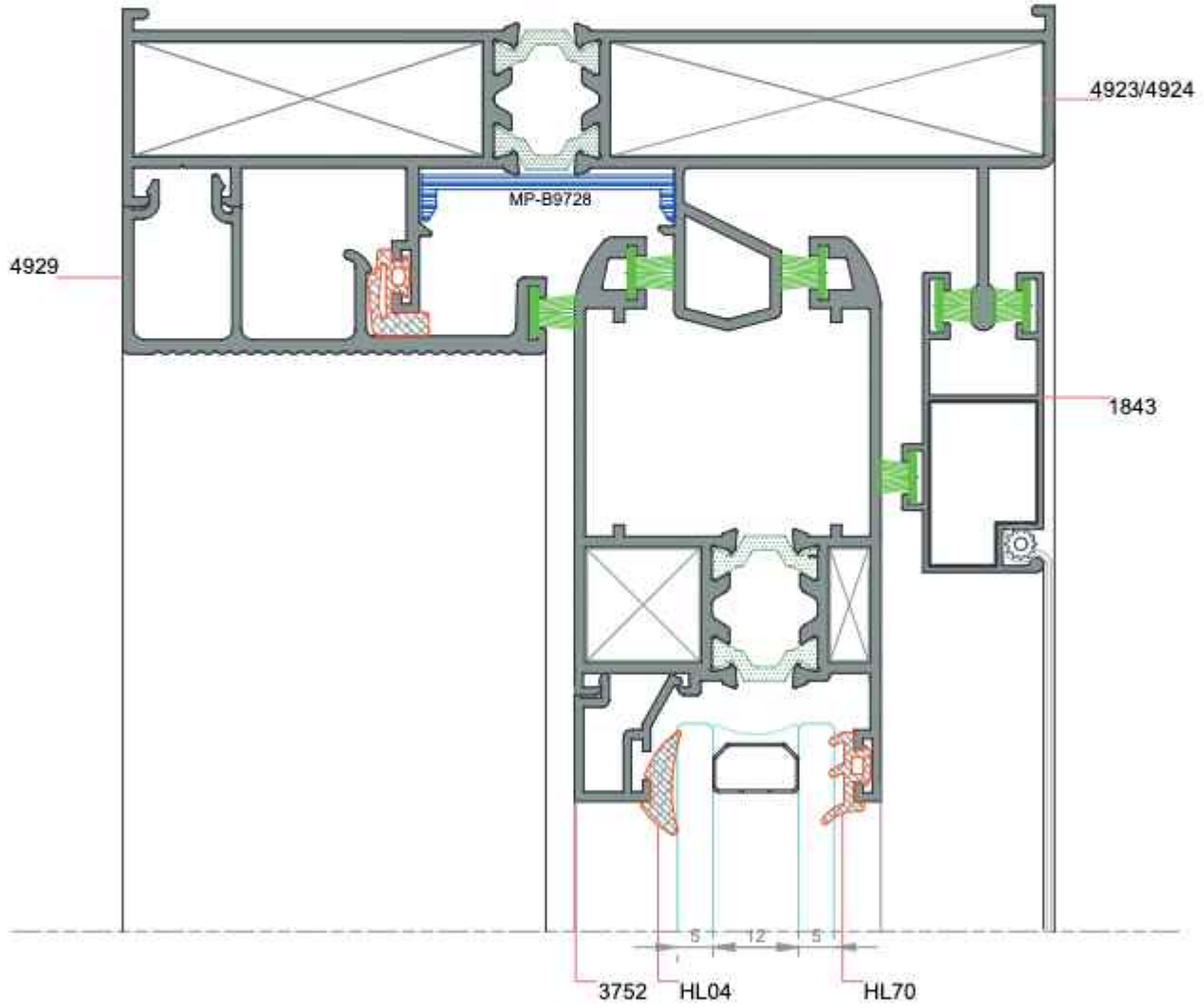



PROFİL KATALOĐU









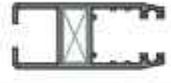
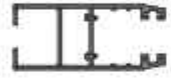

GXY HEKO SERİ

HEKO SLIDING SERIES

* Profil Ađırlıkları Teorik Olup Teslim Anındaki Ađırlık Geerlidir

* *Weight of profiles are theoretical, net weight will valid at the time of delivery.*

★ Yandaki profil birim ağırlıktan, bilgisayarda hesaplanmış teorik ağırlıklardır.

PROFİL KESİTİ	PROFİL KODU	PROFİL ADI	AĞIRLIK	ATALET MOMENTLERİ		SAYFA NO
				J_x (cm ⁴)	J_y (cm ⁴)	
	2832	Kasa Profili	1,344 kg/m	16,13	8,46	
	2954	Pervazlı Kasa Profili	0.927 kg/m	13,50	7.79	
	2833	Kanat Profili	1,049 kg/m	13,20	4,91	
	2955	Kanat Profili	0,756 kg/m	10,99	3,82	
	2840	Kanca Profili	0,435 kg/m	2,88	0,62	
	2956	Kanca Profili	0,300 kg/m	1,90	0,47	
	2837	Rüzgar Kıрма Profili	0,611 kg/m	20,18	0,15	
	2841	Giryaj	0,422 kg/m	
	3305	Çift Kanat Orta Profili	0,221 kg/m	
	3309	Cam Çita Profili	0,137 kg/m	
	3444	Cam Çita Profili	0,185 kg/m	
	2110	Cam Çita Profili	0,316 kg/m	

★ Yandaki profil birim ağırlıkları, bilgisayararda hesaplanmış teorik ağırlıklardır.

AKSESUAR KESİTİ	AKSESUAR KODU	AKSESUAR ADI	AĞIRLIK	PAKETLEME	SAYFA NO
	HL04(3mm)	Kama Fitiği	60 gr/m	15kg/250 m	
	HL31(2mm)	Kama Fitiği	40 gr/m	15kg/375 m	
	HL70	Cam Fitiği	44 gr/m	15 kg/ 340m	
	HE-9600 (03172)	Giese Kol	
	HE-9500	Havuz Kol(Anahtarsız)	
	HE-9100	Sürme Kıl Fitiği (067-550)	
	HE-9000	Rulman	
	HE-4562	Sürme Köşe Bağlantı (22.5X10.5)	
	HE-9001	Stoper Kit	
	HE-9995	Siyah Cam Takoza	...	1pk/ 2000ad	
	HE-9994	Dübel 6 mm	...	1pk/ 1000ad	
	HE-9993	Plastik Tapası(12mm)	...	1pk/ 2000ad	
	HE-9992	Su Tahliye Tapası	...	1pk/ 2000ad	
	MP41-22/1	Buldex Vida	

★ Yandaki profil birim ağırlıkları, bilgisayarda hesaplanmış teorik ağırlıklardır.

AKSESUAR KESİTİ	AKSESUAR KODU	AKSESUAR ADI	AĞIRLIK	PAKETLEME	SAYFA NO
	HE-9991	Tij Plastik 03524590N Siyah 03524542N Gri	
	HE-9998 (PA009)	Yarı Otomatik Tij	
	HE-4001	Silikon-Nötr	
	HE-4000	Silikon	

★ Yandaki profil birim ağırlıkları, bilgisayarda hesaplanmış teorik ağırlıklardır.

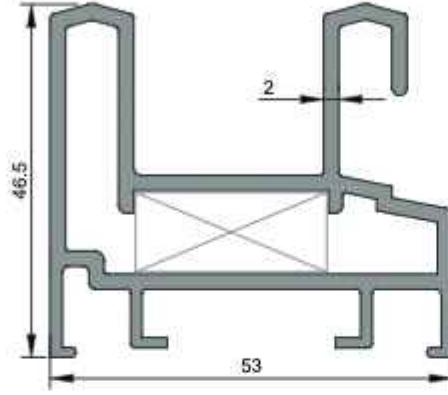

2832
Sürme Kasa Profili
1,344 kg/m
$J_x=16,13 \text{ cm}^4$ $J_y=8,46 \text{ cm}^4$

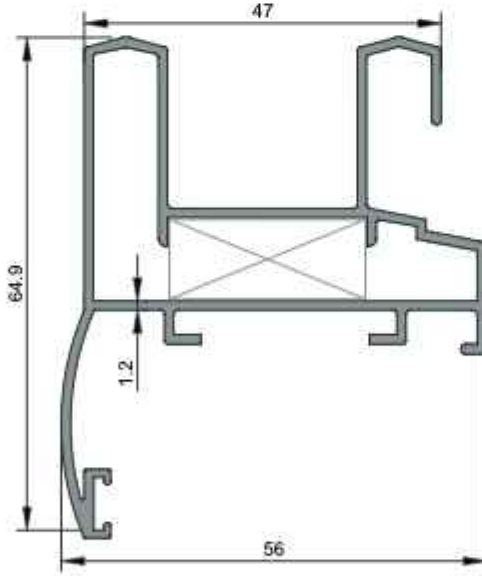

2954
Pervazlı Sürme Kasa Profili
0,927 kg/m
$J_x=13,50 \text{ cm}^4$ $J_y=7,79 \text{ cm}^4$

★ Yandaki profil birim ağırlıkları, bilgisayarda hesaplanmış teorik ağırlıklardır.

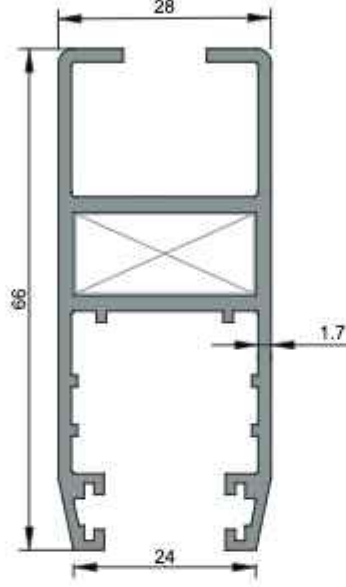

2833
Sürme Kanat Profili
1,049 kg/m
$J_x=13,20 \text{ cm}^4$ $J_y=4,91 \text{ cm}^4$

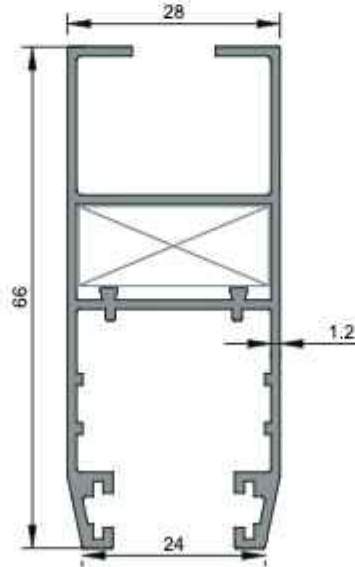

2955
Sürme Kanat Profili
0,786 kg/m
$J_x=10,99 \text{ cm}^4$ $J_y=3,82 \text{ cm}^4$

★ Yandaki profil birim ağırlıkları, bilgisayararda hesaplanmış teorik ağırlıklardır.

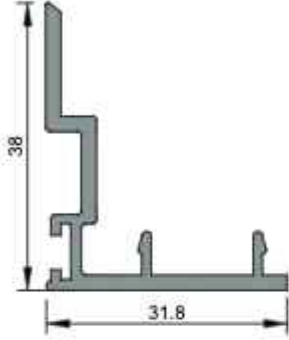

2840
Kanca Profili
0,435 kg/m
$J_x=2,88 \text{ cm}^4$ $J_y=0,62 \text{ cm}^4$

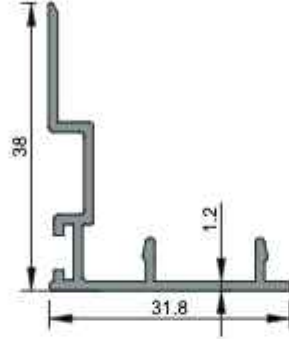

2956
Kanca Profili
0,300 kg/m
$J_x=1,90 \text{ cm}^4$ $J_y=0,47 \text{ cm}^4$

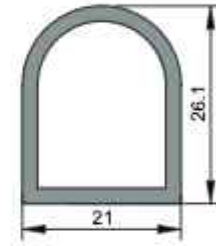

2841
Giryaj Profili
0,422 kg/m

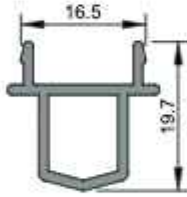

3305
Çift Kanat Orta Profili
0,221 kg/m

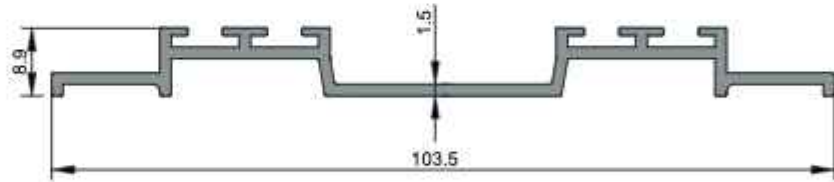

2837
Rüzgar Kıırma Profili
0,611 kg/m
$J_x=20,18 \text{ cm}^4$ $J_y=0,15 \text{ cm}^4$

KÖŞE TAKOZU KESİM ÖLÇÜLERİ

★ Yandaki profil birim ağırlıkları, bilgisayarda hesaplanmış teorik ağırlıklardır.

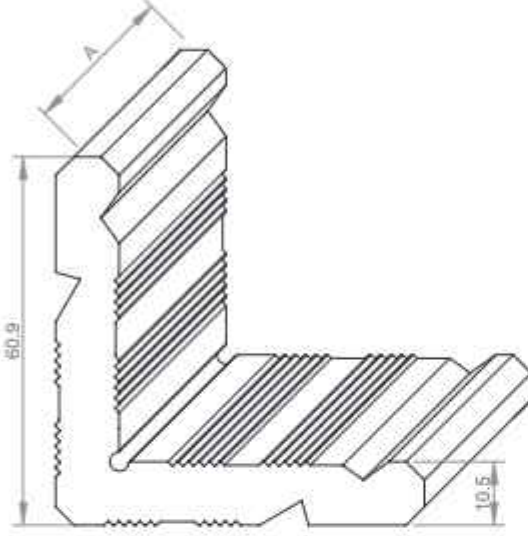

2892

Köşe Takozu

2,829 kg/m

Aksesuar Kodu	Profil Kodu	Kesim Ölçüsü A(mm)
K2892 252	2832	25.2
K2892 258	2954	25.8
K2892 235	2833	23.5
K2892 251	2955	25.1

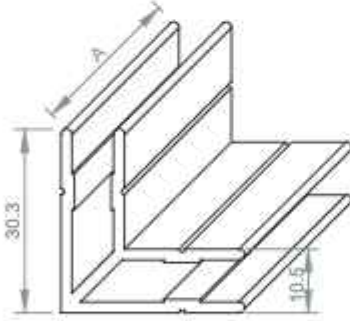

2957

Köşe Takozu

2,925 kg/m

Aksesuar Kodu	Profil Kodu	Kesim Ölçüsü A(mm)
K2957 252	2832	25.2
K2957 258	2954	25.8
K2957 235	2833	23.5
K2957 251	2955	25.1

SÜRME UYGULAMA TİPLERİ

★ Yandaki profil birim ağırlıkları, bilgisayarda hesaplanmış teorik ağırlıklardır.

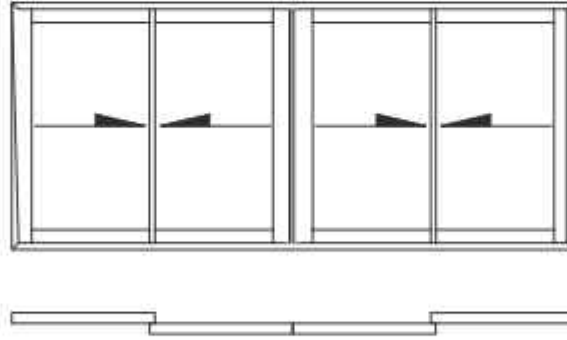
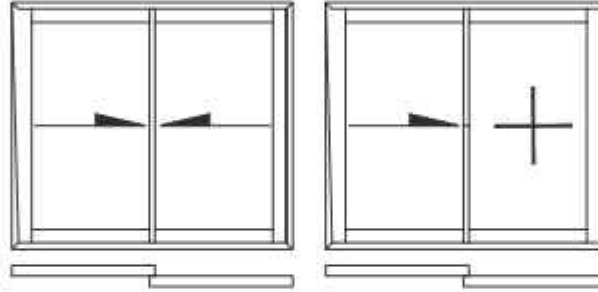

DETAY-1a
ÖLÇEK:1/1

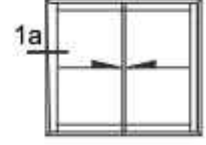

★ Yandaki profil birim ağırlıkları, bilgisayarla hesaplanmış teorik ağırlıklardır.

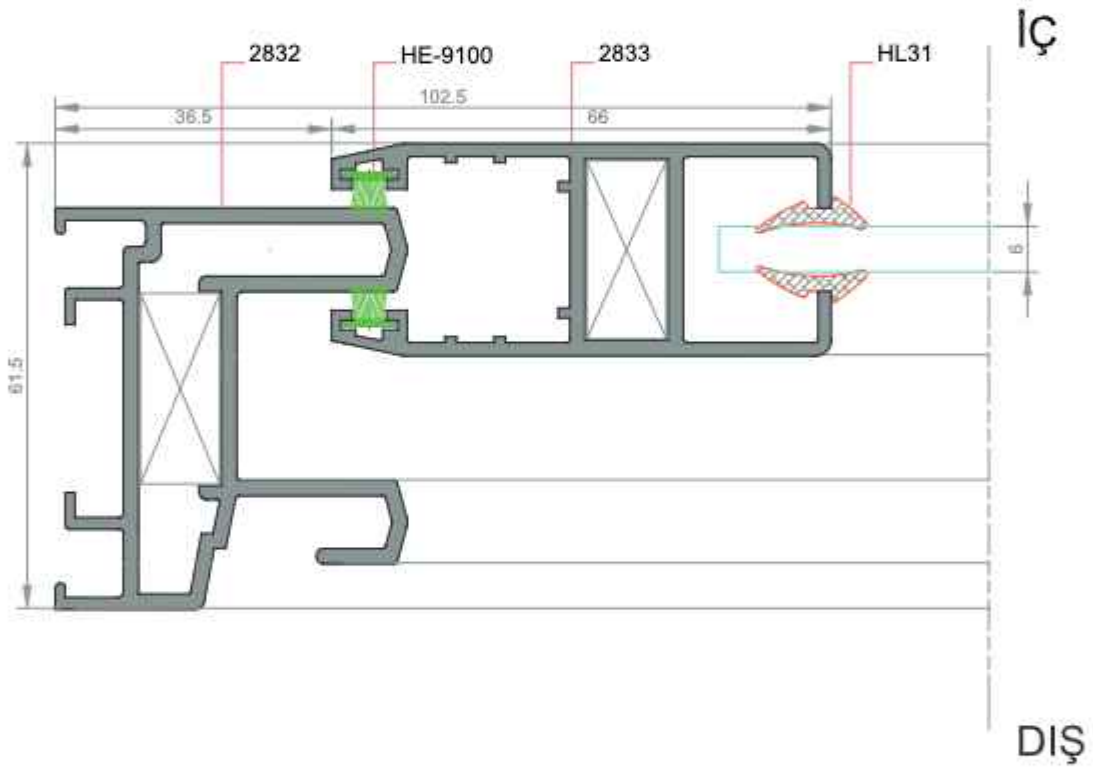

DETAY-1b
ÖLÇEK:1/1

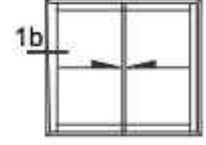

★ Yandaki profil birim ağırlıkları, bilgisayararda hesaplanmış teorik ağırlıklardır.

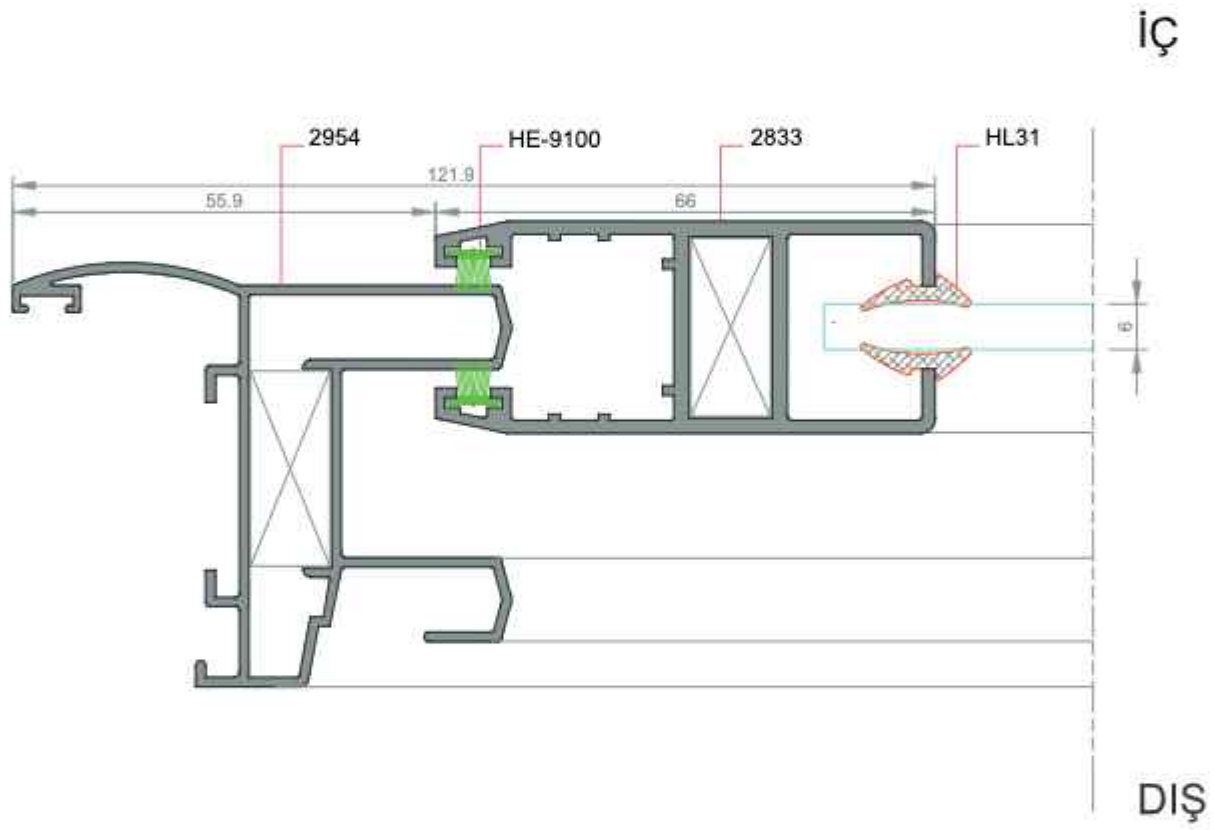

DETAY-2
ÖLÇEK:1/1

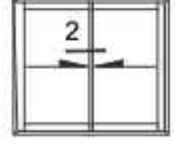

★ Yandaki profil birim ağırlıkları, bilgisayararda hesaplanmış teorik ağırlıklardır.

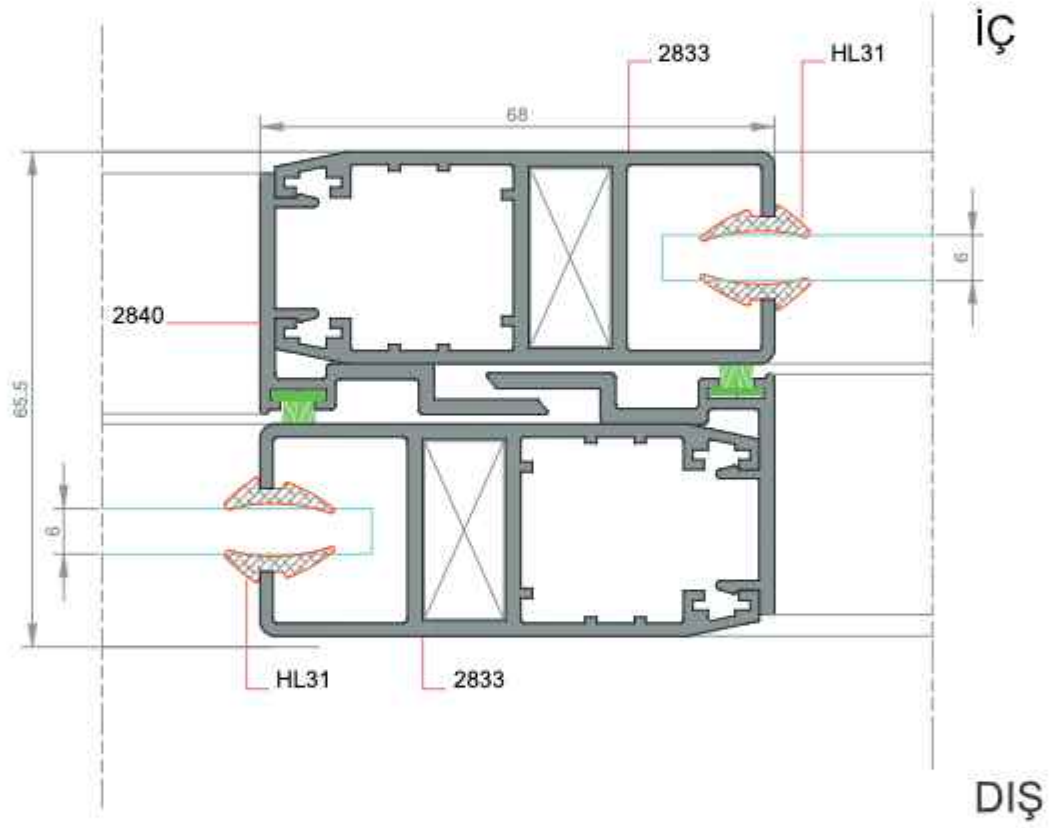

DETAY-3a
ÖLÇEK:1/1

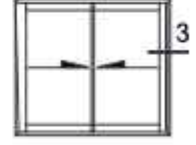

★ Yandaki profil birim ağırlıkları, bilgisayarda hesaplanmış teorik ağırlıklardır.

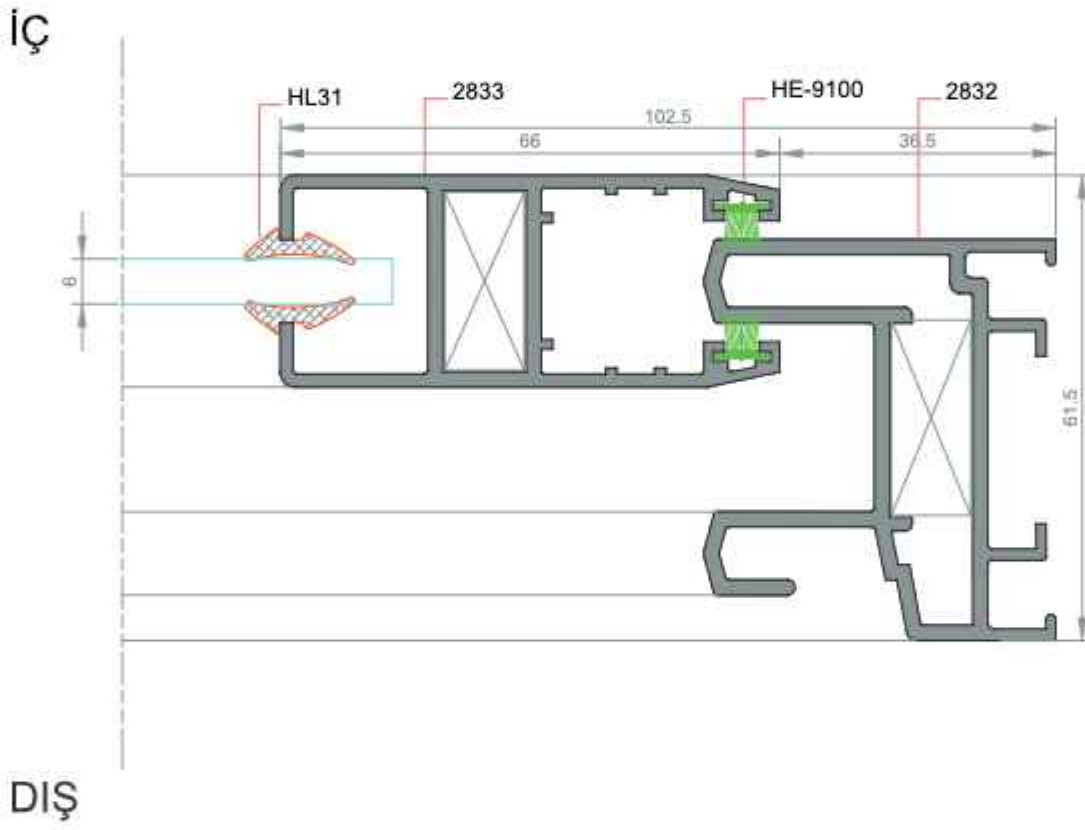

DETAY-3b
ÖLÇEK:1/1

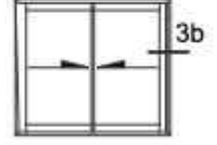

★ Yandaki profil birim ağırlıkları, bilgisayarla hesaplanmış teorik ağırlıklardır.

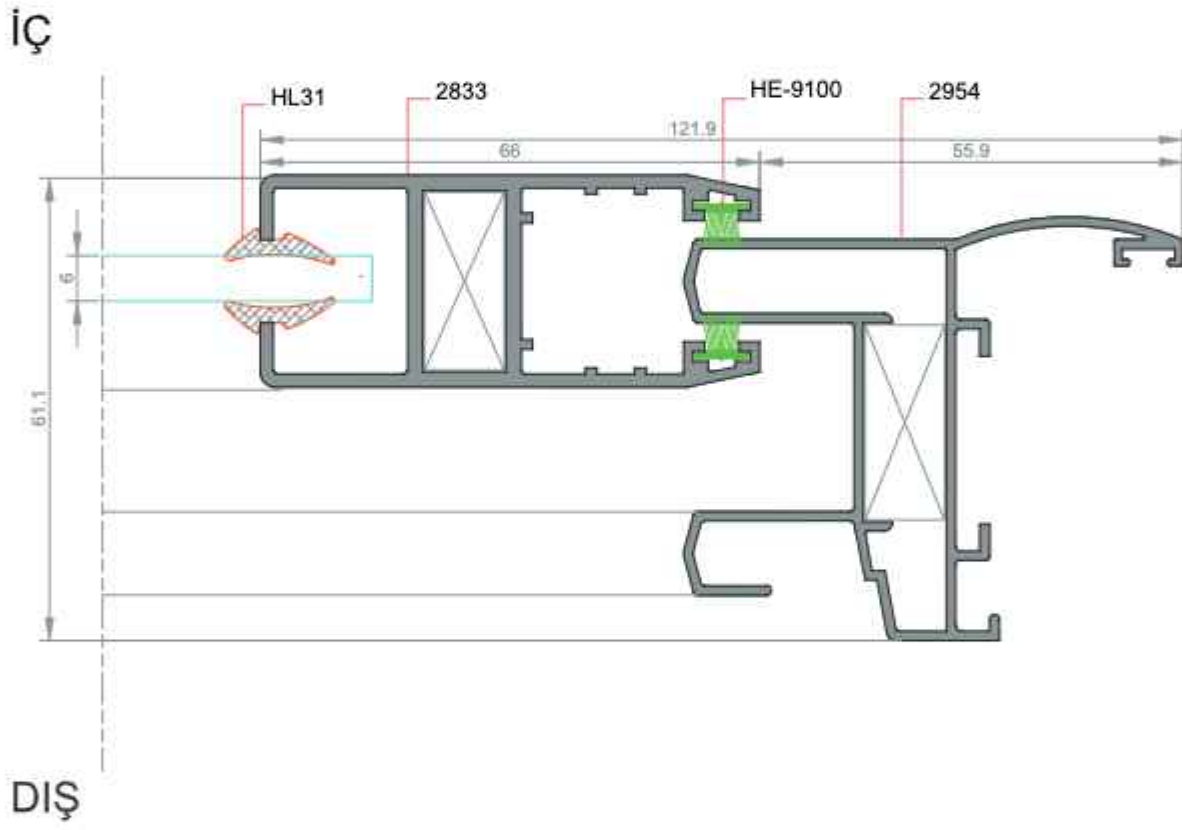

DETAY-4a
ÖLÇEK:1/1

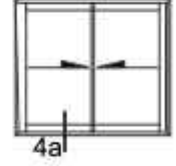

★ Yandaki profil birim ağırlıkları, bilgisayarda hesaplanmış teorik ağırlıklardır.

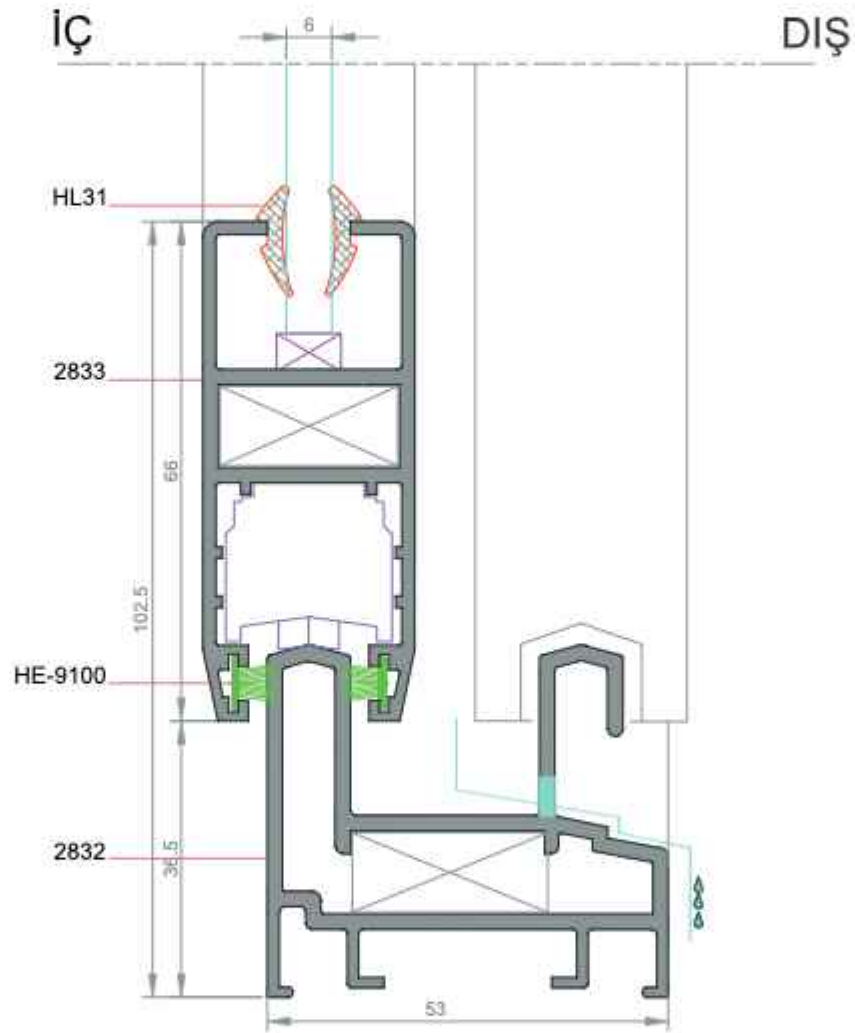

DETAY-4b
ÖLÇEK:1/1

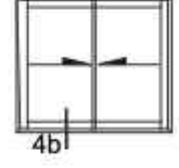

★ Yandaki profil birim ağırlıkları, bilgisayarla hesaplanmış teorik ağırlıklardır.

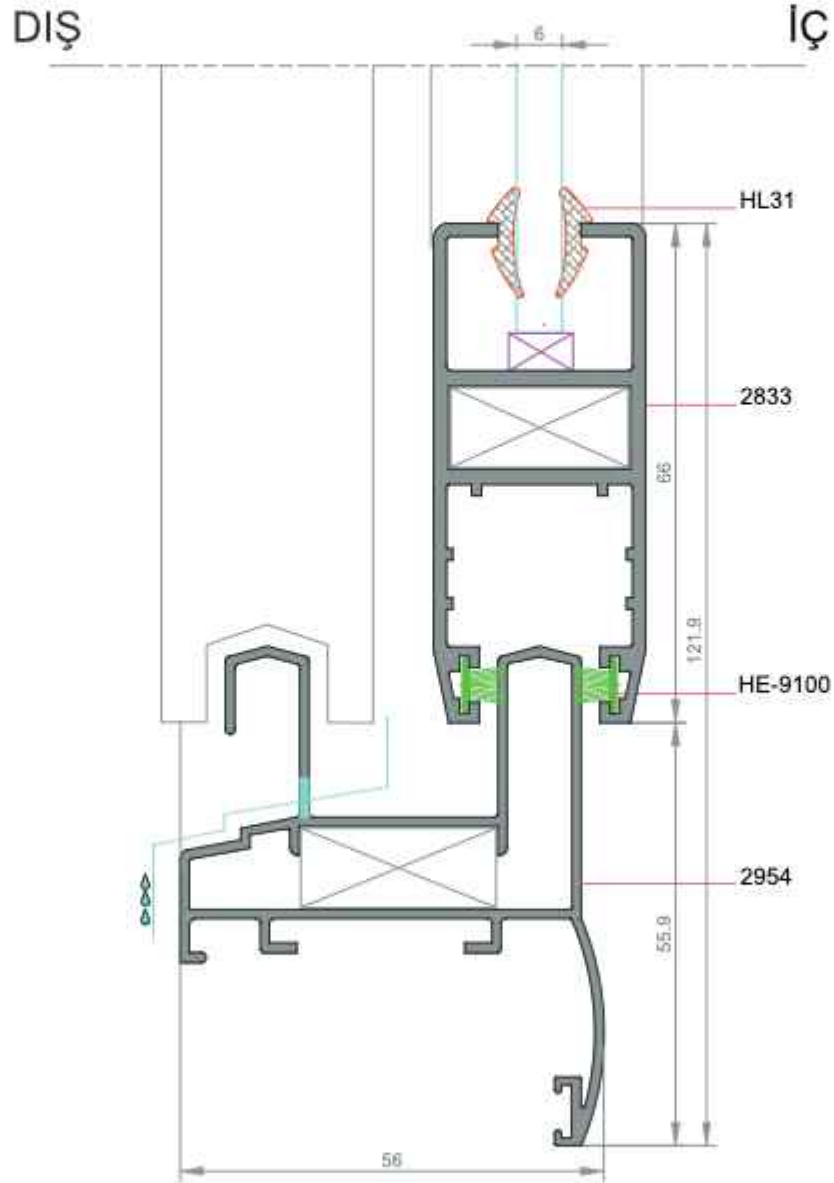

DETAY-5a
ÖLÇEK:1/1

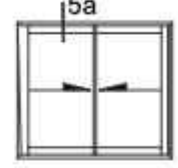

★ Yandaki profil birim ağırlıkları, bilgisayarda hesaplanmış teorik ağırlıklardır.

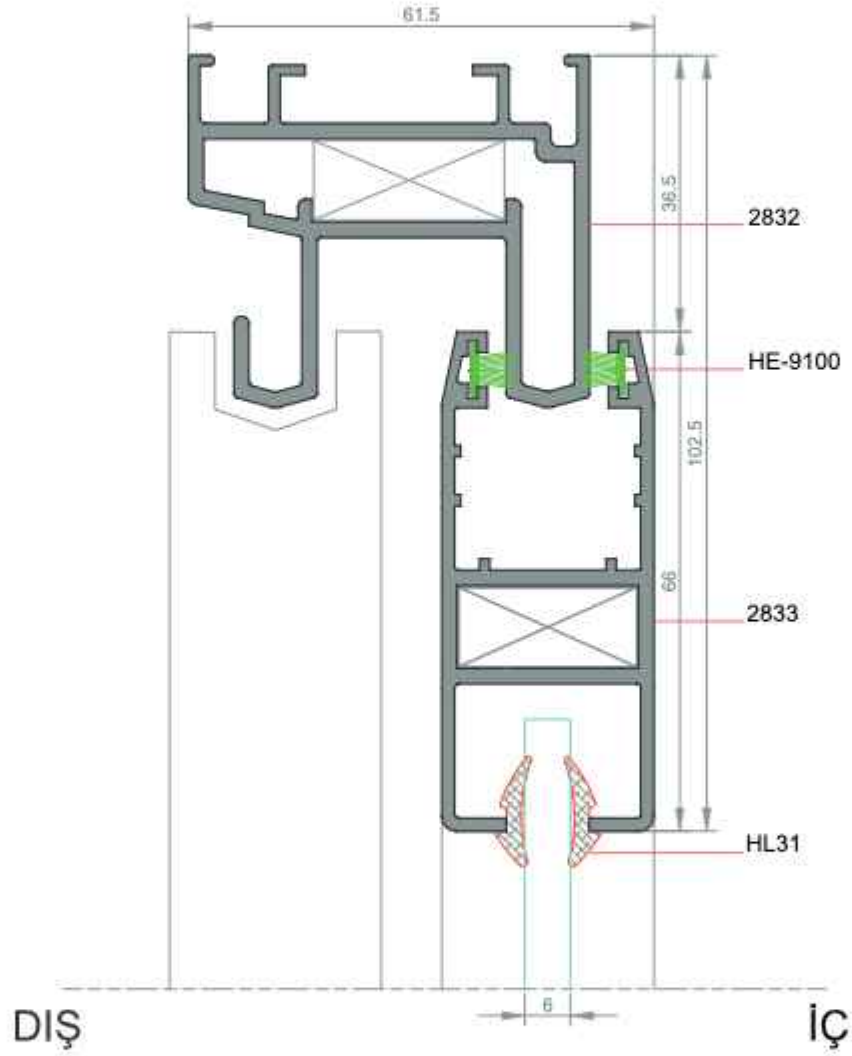

DETAY-5b
ÖLÇEK:1/1

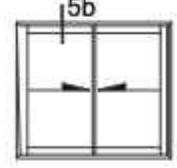

★ Yandaki profil birim ağırlıkları, bilgisayarla hesaplanmış teorik ağırlıklardır.

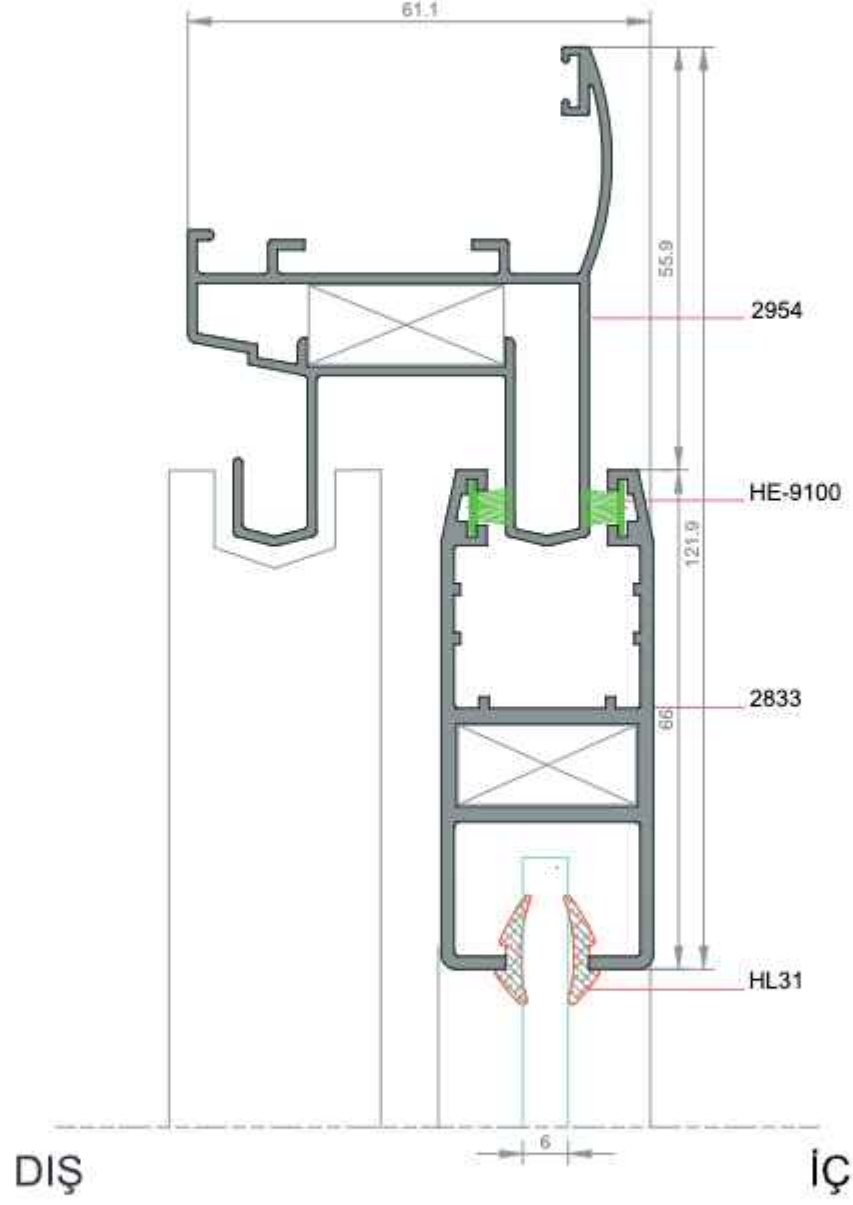

DETAY-6
ÖLÇEK:1/1

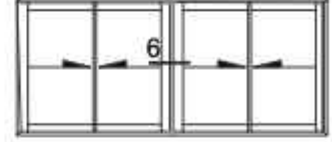

★ Yandaki profil birim ağırlıkları, bilgisayarda hesaplanmış teorik ağırlıklardır.

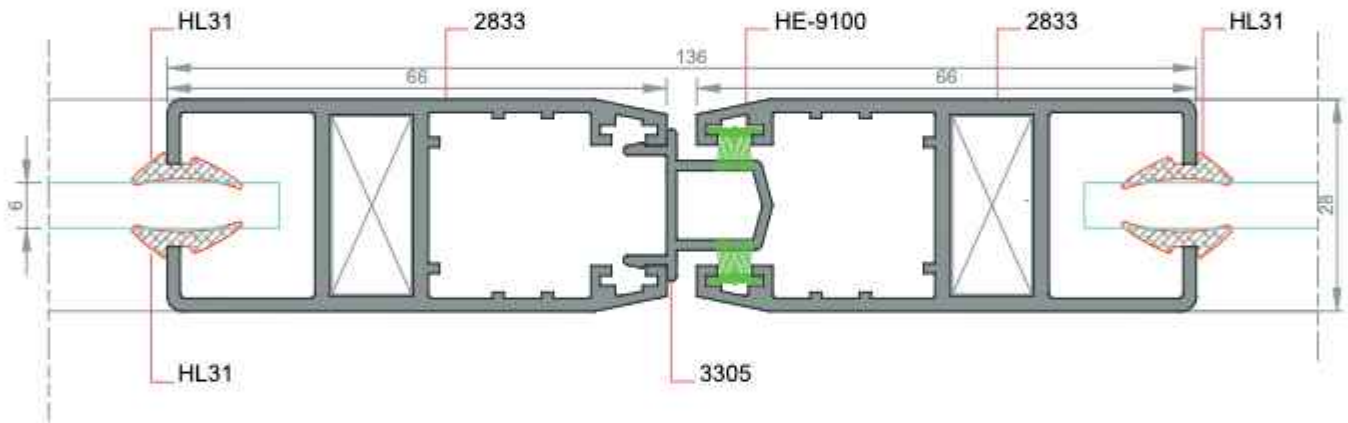

★ Yandaki profil birim ağırlıkları, bilgisayarda hesaplanmış teorik ağırlıklardır.

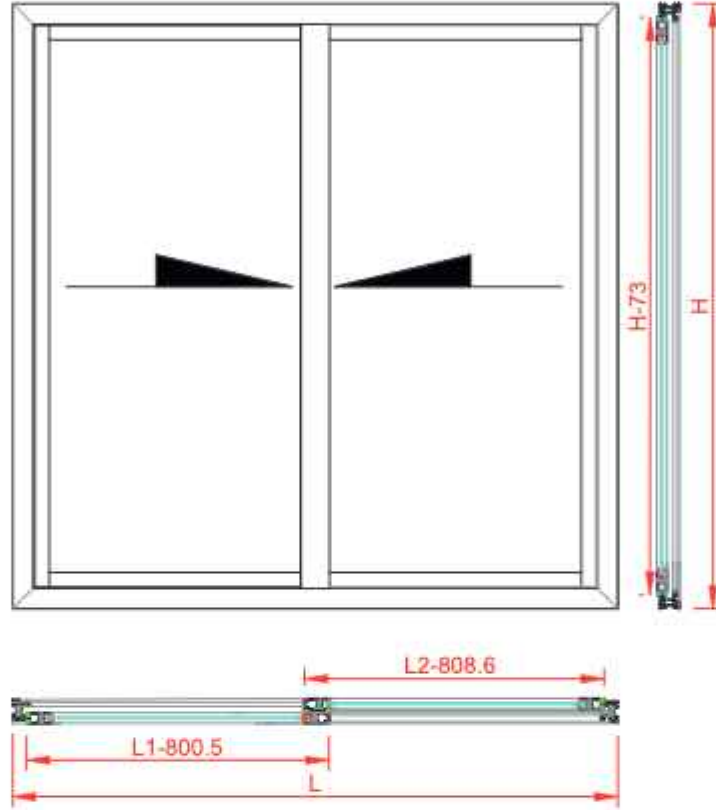

Profilin Adı	Profil Kesiti	Profil Kodu	Adet	Kesim Ölçüsü(mm)
Kasa Profili		2832	2	L
			2	H
Kanat Profili		2833	2	L1-800.5
			2	L2-808.6
			2	H-73
Cam Çitisi Profili	Kanat		2	
			2	
Cam Çitisi Profili	Kasa Orta Kayıt		2	
			2	

Bağlantı Elemanları	Kod	Birim	Miktar
Köşe Takozu (Kasa)	K2892 252	Adet	4
Köşe Takozu (Kanat)	K2892 235	Adet	4

Cam (Açılır)	Adet	Cam Detayı	Kesim Ölçüsü (mm)
Dış Cam	2		
İç Cam			

Aksesuar	Adet	Detayı
Rulman	4	



PROFİL KATALOĐU











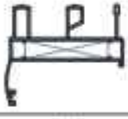

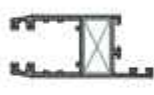
HEKO SİNEKLİK SÜRME SERİ

GXY HEKO SLIDING WINDOW WITH SCREEN





* Profil Ađırlıkları Teorik Olup Teslim Anındaki Ađırlık Geerlidir

* *Weight of profiles are theoretical, net weight will valid at the time of delivery.*















★ Yandaki profil birim ağırlıkları, bilgisayarda hesaplanmış teorik ağırlıklardır.

PROFİL KESİTİ	PROFİL KODU	PROFİL ADI	AĞIRLIK	ATALET MOMENTLERİ		SAYFA NO
				J_x (cm ⁴)	J_y (cm ⁴)	
	3310	Kasa Profili	1,163kg/m	28,52	6,48	
	2332	Pervazlı Kasa Profili	1,285 kg/m	35,58	10,76	
	3306	Orta Kayıt Profili	1,111 kg/m	32,90	5,13	
	3307	Orta Kayıt Profili	0,539 kg/m	2,83	2,07	
	3308	Çıtalı Kanat Profili	0,800 kg/m	9,00	3,57	
	3660	Çıtalı Geniş Kanat Adaptörü	0,935 kg/m	19,64	4,53	
	1843	Sürme Sineklikli Profili	0,359 kg/m	
	2956	Kanca Profili	0.300 kg/m	
	2840	Kanca Profili	0,436 kg/m	
	3452	Pervaz Profili	0,235 kg/m	
	3305	Çift Kanat Adaptörü	0,221 kg/m	
	3309	Cam Çıtası	0,137 kg/m	
	3444	Oval Cam Çıtası	0,185 kg/m	
	2110	Düz Cam Çıtası	0,190 kg/m	

★ Yandaki profil birim ağırlıkları, bilgisayarda hesaplanmış teorik ağırlıklardır.

PROFİL KESİTİ	PROFİL KODU	PROFİL ADI	AĞIRLIK	ATALET MOMENTLERİ		SAYFA NO
				J_x (cm ⁴)	J_y (cm ⁴)	
	2115	Orta Kayıt Bağlantısı	0,334 kg/m	
	2837	Rüzgar Kırma Profili	0,611 kg/m	
	2841	Orta Kayıt Bağlantısı	0,422 kg/m	
	2114	Köşe Takoğu	0,556 kg/m	
	1948	Köşe Takoğu	1,240 kg/m	
	3871	Köşe Takoğu	3,234 kg/m	
	1538	Köşe Takoğu	3,611 kg/m	

★ Yandaki profil birim ağırlıkları, bilgisayarda hesaplanmış teorik ağırlıklardır.

AKSESUAR KESİTİ	AKSESUAR KODU	AKSESUAR ADI	AĞIRLIK	PAKETLEME	SAYFA NO
	HL70	Cam Fiteli	44 gr/m	15 kg/ 340m	
	HL31(2mm)	Kama Fiteli	40 gr/m	15 kg/ 375m	
	HL04(3mm)	Kama Fiteli	60 gr/m	15kg/ 250m	
	MP32-13/5	Sürme Seri Tetik Kol	...	12 kg/ 100ad	
	MP52-5018	Sürme Sineklikli Havuz Kol	...	100 ad	
	HE-9000	Rulman	...	200 Ad/paket	
	MP52-5060	Sürme Sineklikli Rulman	...	100 ad	
	MP57-06/ MP57-07-5025	Sineklikli Fiteli(Gergi Kordonu)	
	HE-9100	Sürme Kıl Fiteli Pb067-550	...	100 Mt/paket	
	HE-9001	Stoper Kit	
	MP52-5007	Sineklikli Köşe Takozu	...	100 ad	
	MP52-5006	Köşe Takozu	
	MP54-9160	Fiberglass Tül Gri 160cm*30m	...	48 m2	
	HE-9500	Rescara Havuz Kol(Anahtarsız)	

★ Yandaki profil birim ağırlıkları, bilgisayarda hesaplanmış teorik ağırlıklardır.

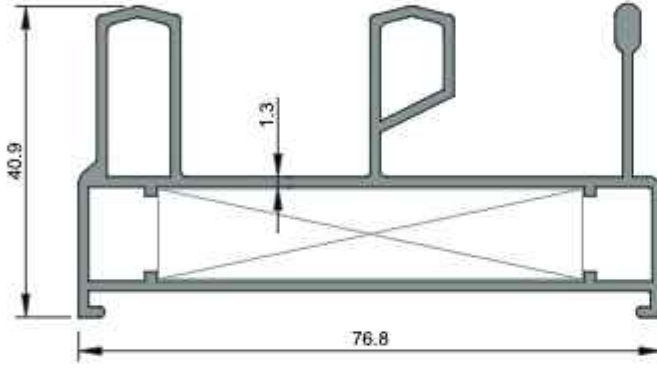

3310
Kasa Profili
1,163 kg/m
Jx=28,52 cm ⁴ Jy=6,48 cm ⁴

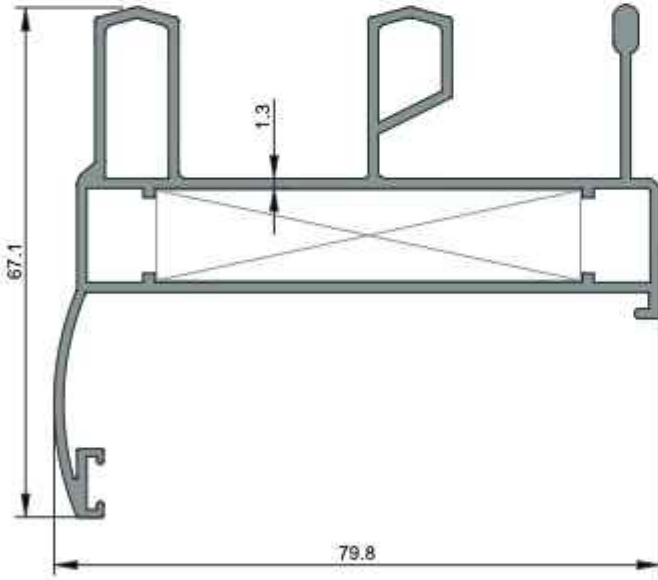

2332
Pervazlı Kasa Profili
1,285 kg/m
Jx=35,58 cm ⁴ Jy=10,76 cm ⁴

...

★ Yandaki profil birim ağırlıkları, bilgisayararda hesaplanmış teorik ağırlıklardır.

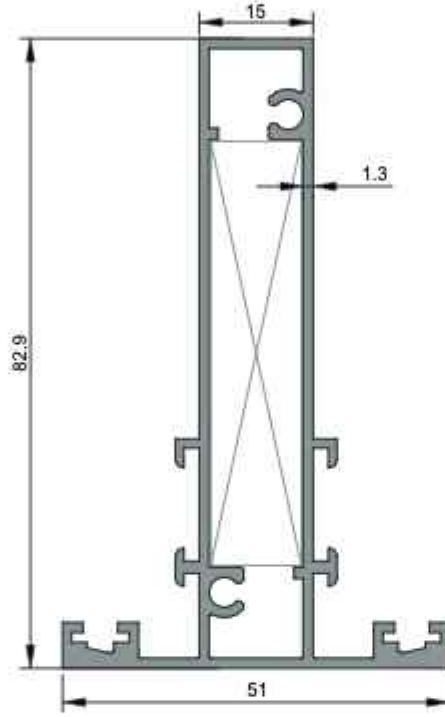

3306
Orta Kayıt Profili
1,111 kg/m
$J_x=32,90 \text{ cm}^4$ $J_y=5,13 \text{ cm}^4$

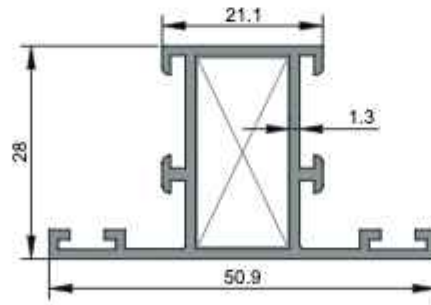

3307
Orta Kayıt Profili
0,539 kg/m
$J_x=2,83 \text{ cm}^4$ $J_y=2,07 \text{ cm}^4$

★ Yandaki profil birim ağırlıkları, bilgisayarda hesaplanmış teorik ağırlıklardır.

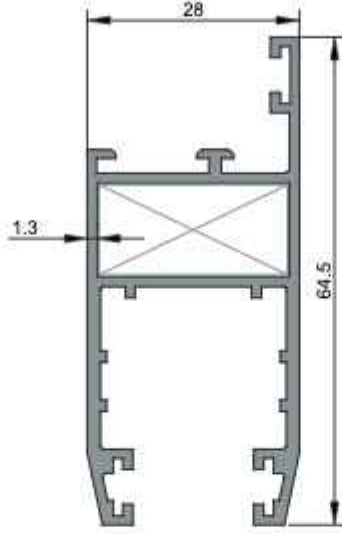

3308
Çıtalı Kanat Profili
0,800 kg/m
$Jx=9,00 \text{ cm}^4$ $Jy=3,57 \text{ cm}^4$

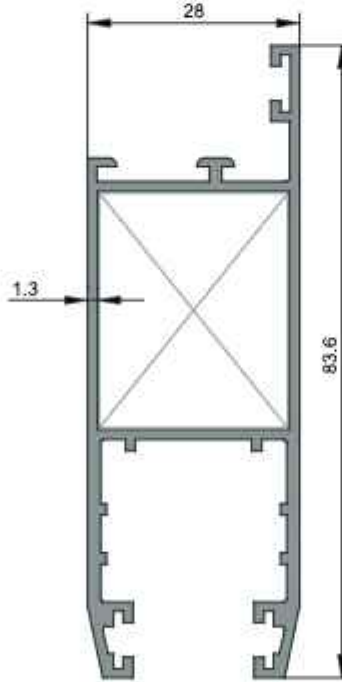

3660
Çıtalı Geniş Kanat Profili
0,935 kg/m
$Jx=19,64 \text{ cm}^4$ $Jy=4,53 \text{ cm}^4$

★ Yandaki profil birim ağırlıkları, bilgisayarla hesaplanmış teorik ağırlıklardır.

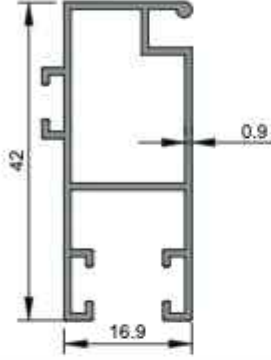

1843
Sürme Sineklik Profili
0,359 kg/m
Jx=2,34 cm ⁴ Jy=0,65 cm ⁴

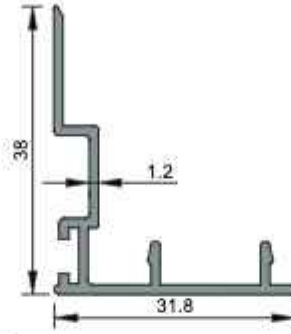

2956
Kanca Profili
0,300 kg/m

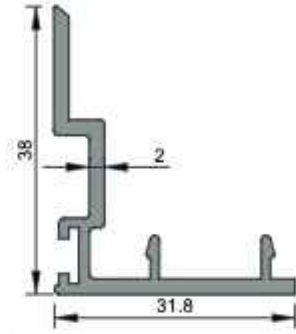

2840
Kanca Profili
0,436 kg/m

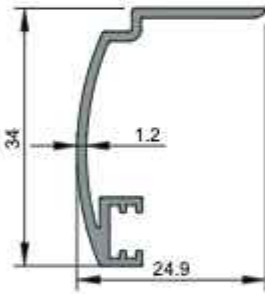

3452
Pervaz Profili
0,235 kg/m

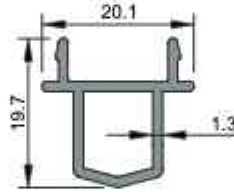

3305
Çift Kanat Adaptörü
0,221 kg/m

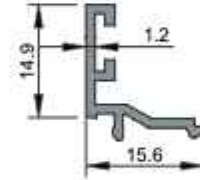

3309
Cam Çıtası
0,137 kg/m



3444
Oval Cam Çıtası
0,185 kg/m

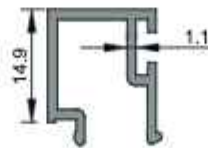

2110
Düz Cam Çıtası
0,190 kg/m

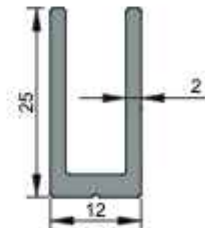

2115
Orta Kayıt Bağlantısı
0,334 kg/m

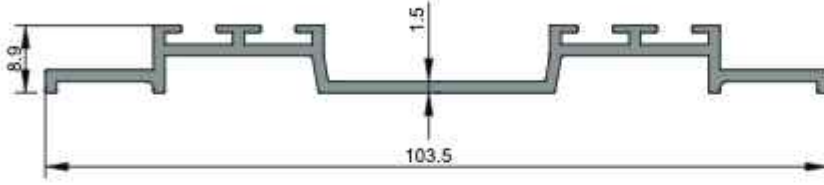

2837
Rüzgar Kırma Profili
0,611 kg/m

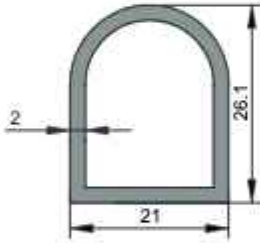

2841
Girya Profili
0,422 kg/m

★ Yandaki profil birim ağırlıkları, bilgisayarda hesaplanmış teorik ağırlıklardır.

KÖŞE TAKOZU KESİM ÖLÇÜLERİ

★ Yandaki profil birim ağırlıkları, bilgisayararda hesaplanmış teorik ağırlıklardır.

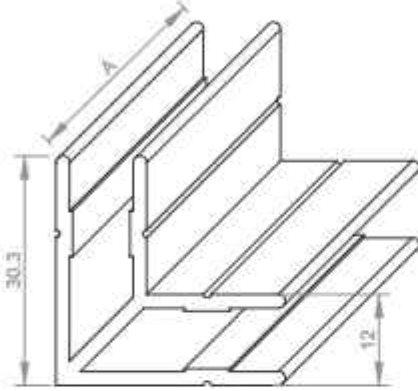

2114
Köşe Takozu
0,556 kg/m

Aksesuar Kodu	Profil Kodu	Kesim Ölçüsü A(mm)
K2114 558	3310	55.8
K2114 558	3306	55.8
K2114 249	3307	24.9
K2114 249	3308	24.9

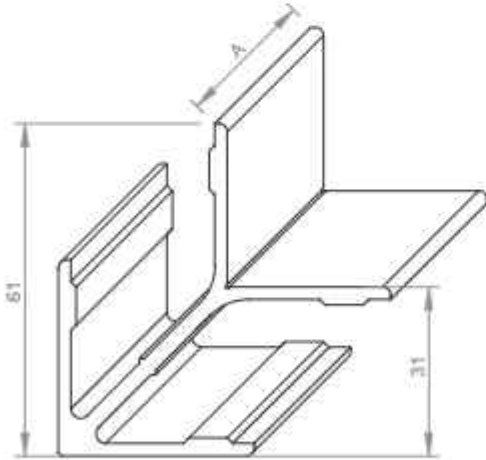

1948
Köşe Takozu
1,240 kg/m

Aksesuar Kodu	Profil Kodu	Kesim Ölçüsü A(mm)
K1948 249	3660	24.9

KÖŞE TAKOZU KESİM ÖLÇÜLERİ

★ Yandaki profil birim ağırlıkları, bilgisayararda hesaplanmış teorik ağırlıklardır.

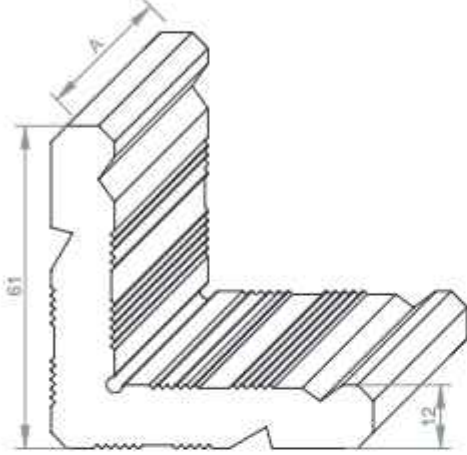

3871

Köşe Takoğu

3,234 kg/m

Aksesuar Kodu	Profil Kodu	Kesim Ölçüsü A(mm)
K3871 558	3310	55.8
K3871 558	3306	55.8
K3871 249	3307	24.9
K3871 249	3308	24.9

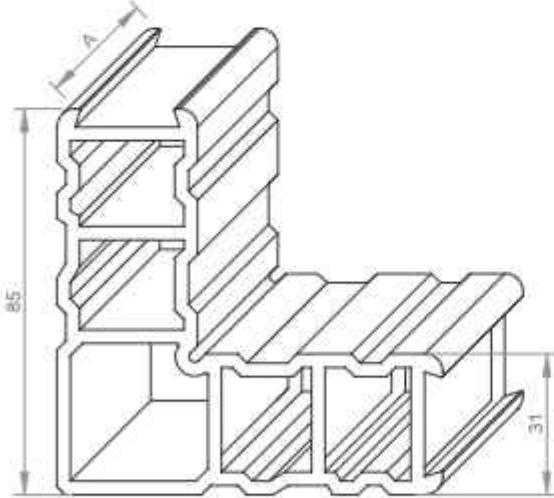

1538

Köşe Takoğu

3,611 kg/m

Aksesuar Kodu	Profil Kodu	Kesim Ölçüsü A(mm)
K1538 249	3660	24.9

ÖLÇEK:1/1

CAMLAMA SEÇENEK TABLOSU

★ Yandaki profil birim ağırlıkları, bilgisayarla hesaplanmış teorik ağırlıklardır.

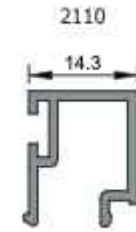
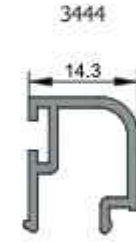
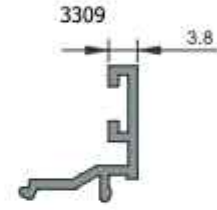
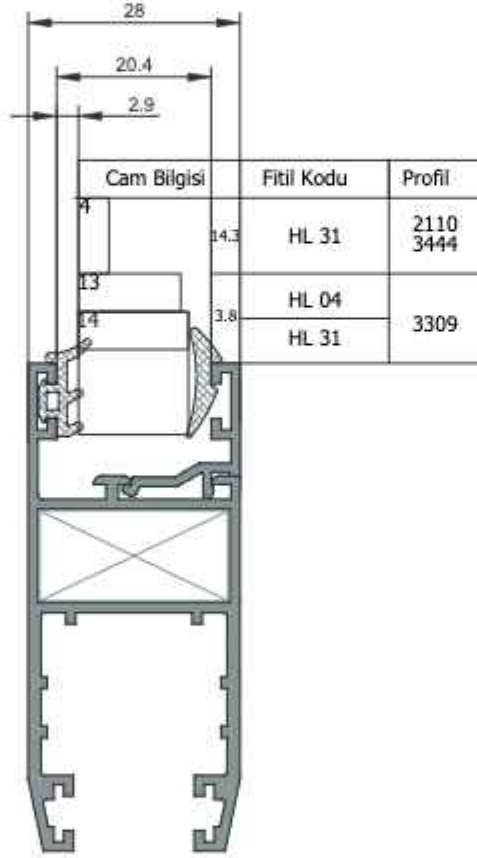

SÜRME UYGULAMA TİPLERİ

★ Yandaki profil birim ağırlıkları, bilgisayarda hesaplanmış teorik ağırlıklardır.

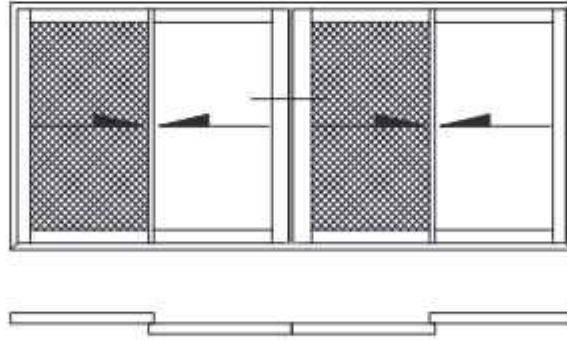
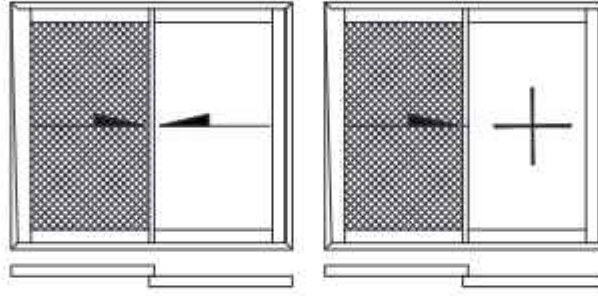

DETAY-1
ÖLÇEK:1/1

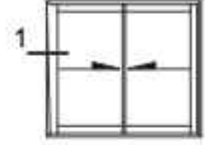

★ Yandaki profil birim ağırlıkları, bilgisayarla hesaplanmış teorik ağırlıklardır.

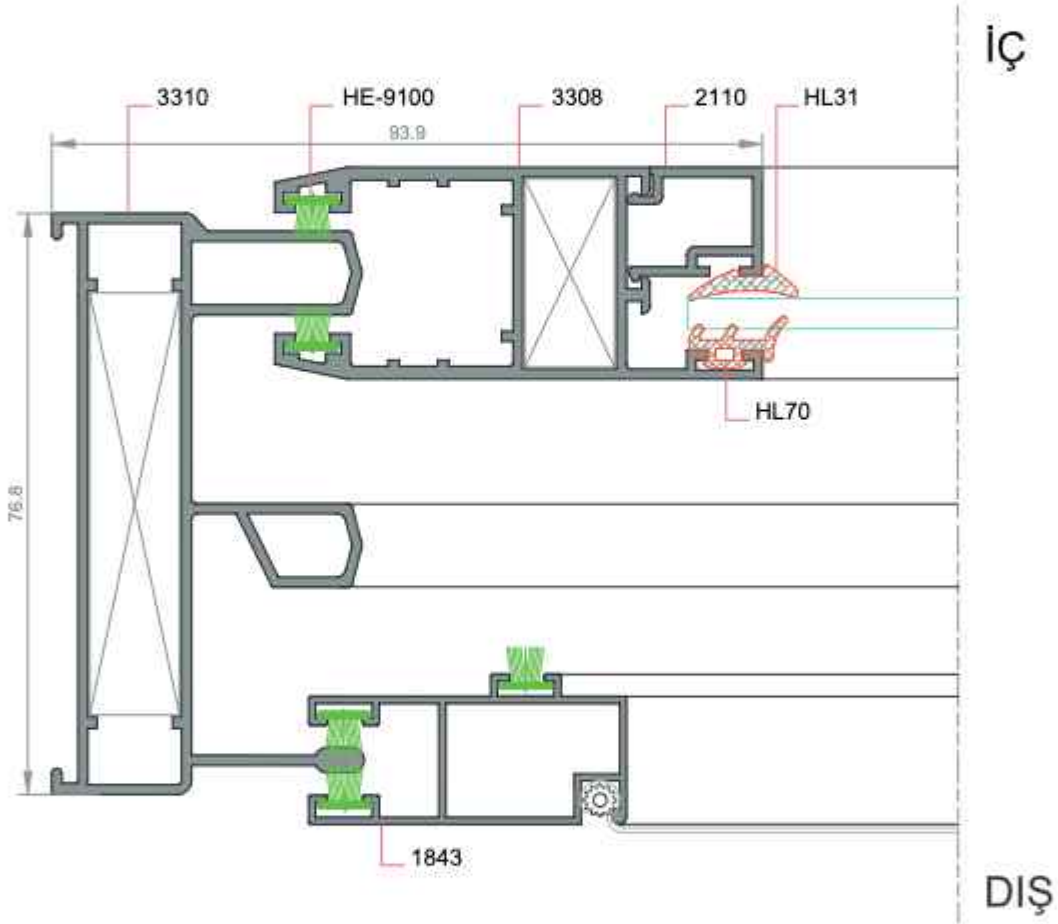

DETAY-2
ÖLÇEK:1/1

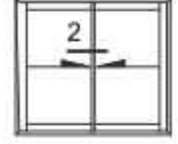

★ Yandaki profil birim ağırlıkları, bilgisayarda hesaplanmış teorik ağırlıklardır.

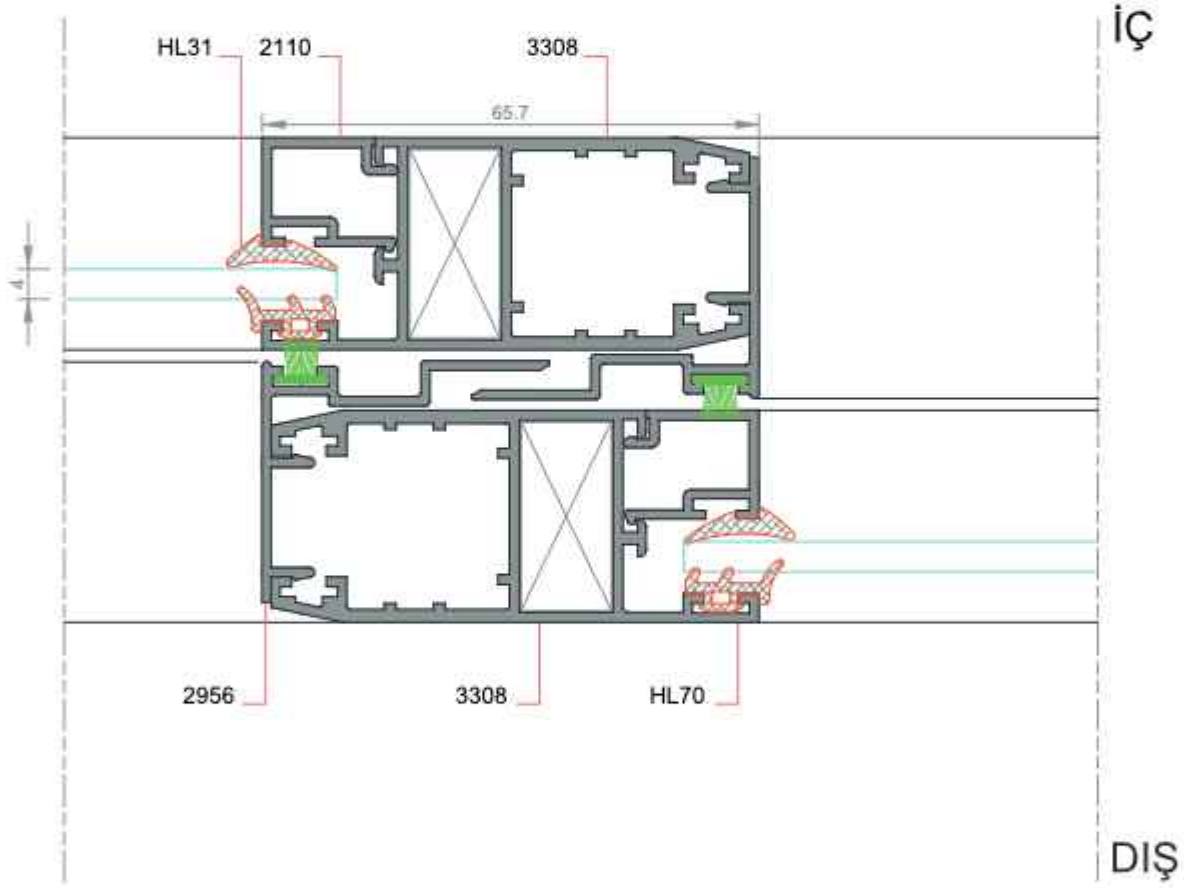

DETAY-3
ÖLÇEK:1/1

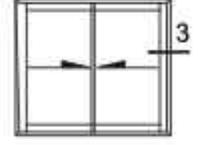

★ Yandaki profil birim ağırlıkları, bilgisayarla hesaplanmış teorik ağırlıklardır.

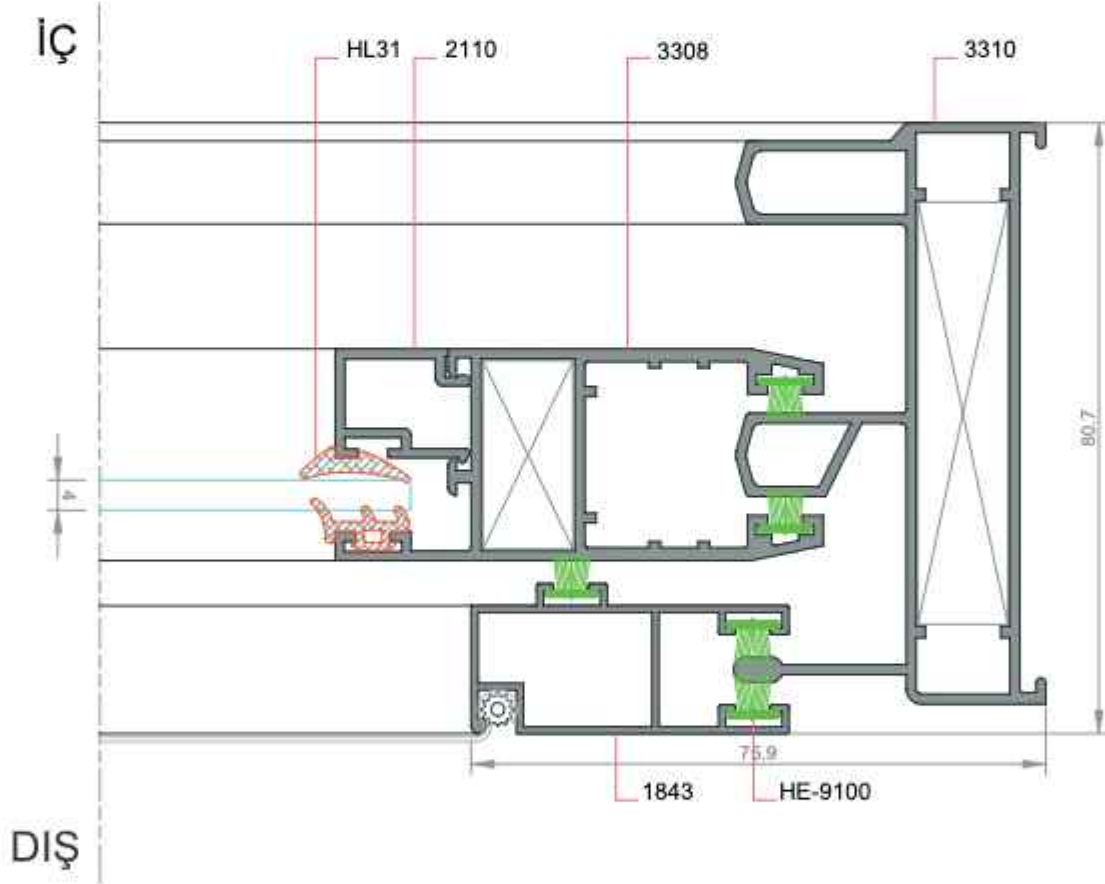

DETAY-4
ÖLÇEK:1/1

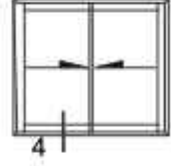

★ Yandaki profil birim ağırlıkları, bilgisayarla hesaplanmış teorik ağırlıklardır.

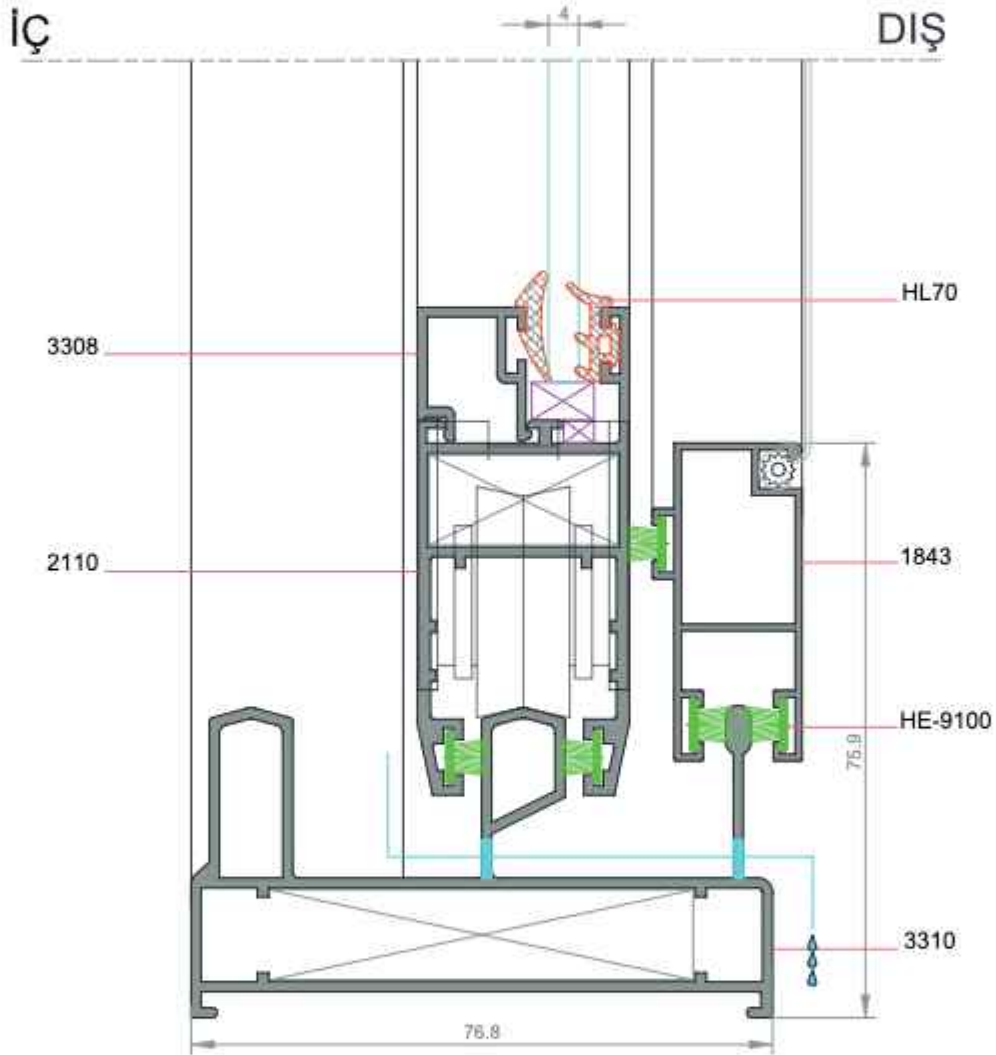

DETAY-5
ÖLÇEK:1/1

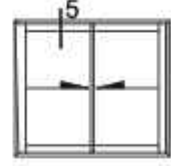

★ Yandaki profil birim ağırlıkları, bilgisayarla hesaplanmış teorik ağırlıklardır.

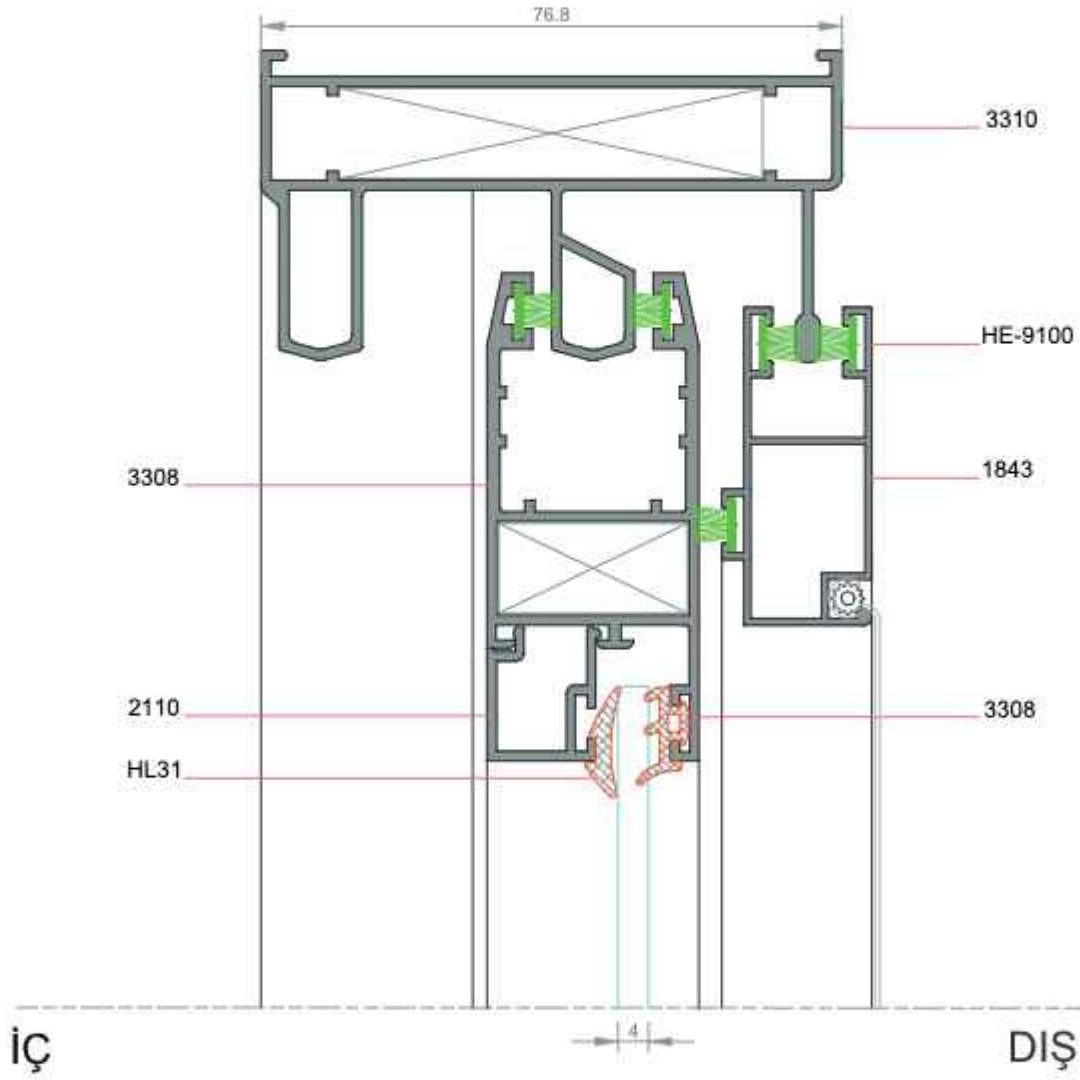

DETAY-1
ÖLÇEK:1/1

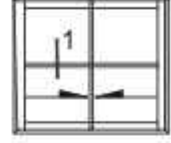

★ Yandaki profil birim ağırlıkları, bilgisayararda hesaplanmış teorik ağırlıklardır.

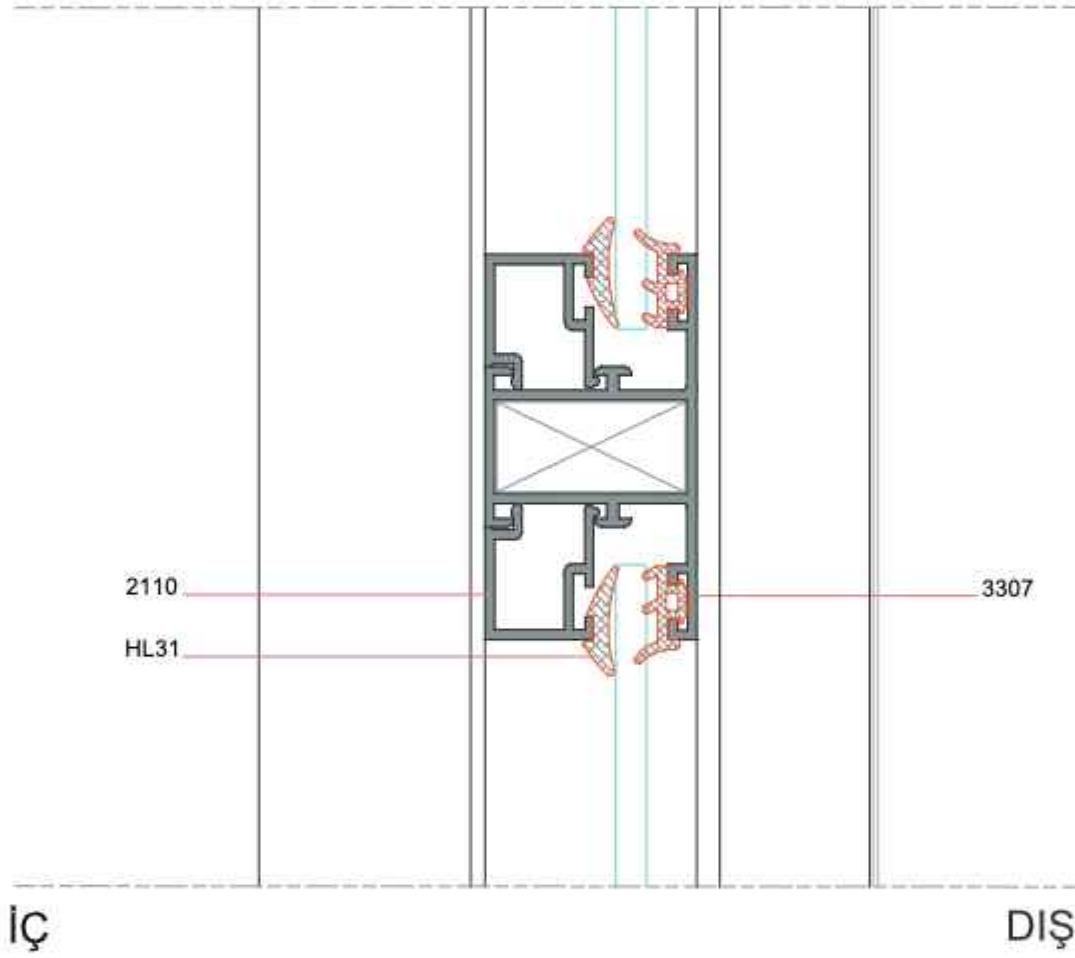

DETAY-1
ÖLÇEK:1/1

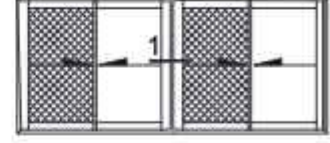

★ Yandaki profil birim ağırlıkları, bilgisayarda hesaplanmış teorik ağırlıklardır.

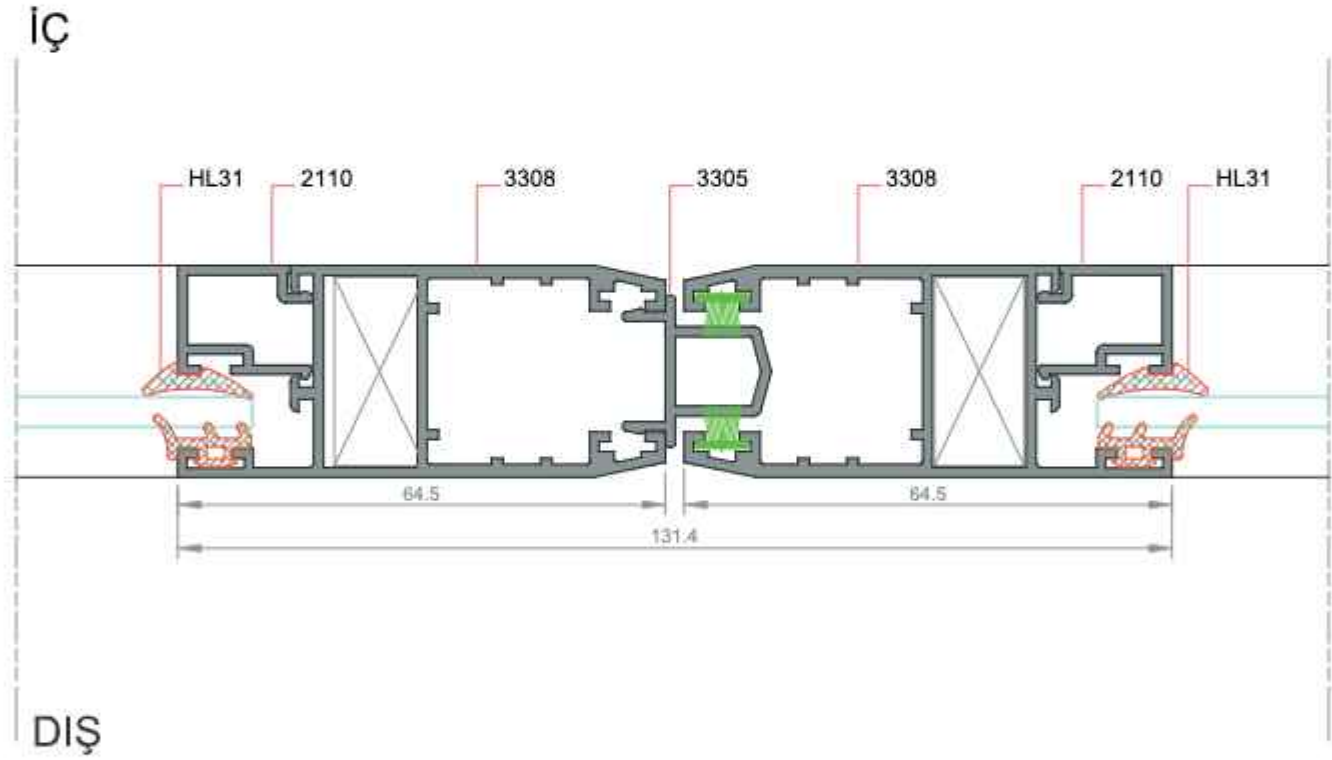

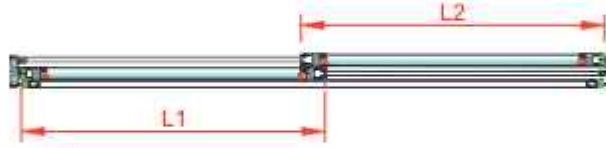
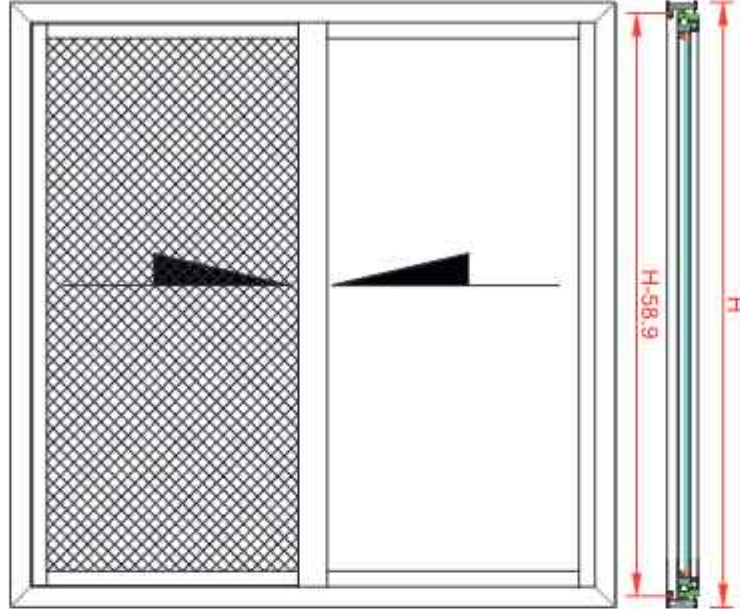

★ Yandaki profil birim ağırlıkları, bilgisayarda hesaplanmış teorik ağırlıklardır.

Profilin Adı	Profil Kesiti	Profil Kodu	Adet	Kesim Ölçüsü(mm)
Kasa Profili		3310	2	L
			2	H
Kanat Profili		3308	4	L-797.5
			4	H-58.9
Sineklik		1843	2	L3-802
			2	H2-67.9
Cam Çıtası Profili <small>Not: Cam Çıtası profilinin yüksekliği ürünün cam ölçüsüne göre belirlenmelidir.</small>			2	
			2	
Cam Çıtası Profili <small>Not: Cam Çıtası profilinin yüksekliği ürünün cam ölçüsüne göre belirlenmelidir.</small>			2	
			2	

Bağlantı Elemanları	Kod	Birim	Miktar
Köşe Takozu (Kasa)	K3546 558	Adet	4
Köşe Takozu (Kanat)	K3546 249	Adet	8

Cam (Açılır)	Adet	Cam Detayı	Kesim Ölçüsü (mm)
Dış Cam	1		
İç Cam			



PROFİL KATALOĐU

GXY KAPAKLI VE SİLİKON CEPHE

GXYCURTAIN WALL SYSTEMS



-STRUCTURAL SILICON SYSTEM

-STRUCTURAL CLIPS SYSTEM













* Profil Ađırlıkları Teorik Olup Teslim Anındaki Ađırlık Geerlidir

* *Weight of profiles are theoretical, net weight will valid at the time of delivery.*



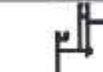









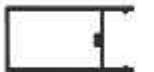

★ Yandaki profil birim ağırlıkları, bilgisayarda hesaplanmış teorik ağırlıklardır.

PROFİL KESİTİ	PROFİL KODU	PROFİL ADI	AĞIRLIK	ATALET MOMENTLERİ		SAYFA NO
				J_x (cm ⁴)	J_y (cm ⁴)	
	2909/10 (1.6 mm)	Dar Kasa Profili	1,319 kg/m	17,20	5,99	
	2909/13 (1.6mm)	Dar Orta Kayıt Profili	1,424 kg/m	18,67	9,51	
	2911/12 (1.6mm)	Dar Kanat Profili	1,435 kg/m	28,76	6,52	
	2650/51 (1.4mm)	Geniş Kasa Profili	1,387 kg/m	18,86	10,22	
	2650/51 (1.6mm)	Geniş Kasa Profili	1,510 kg/m	20,94	12,69	
	2650/51 (1.8mm)	Geniş Kasa Profili	1,595 kg/m	22,44	13,22	
	4718/19 (1.4mm)	Oval Kasa Profili	1,845 kg/m	37,22	24,55	
	4452/53 (1.6mm)	Geniş Kasa Profili	1,702 kg/m	24,67	17,95	
	4452/53 (1.8mm)	Geniş Kasa Profili	1,779 kg/m	26,12	19,00	
	4894/4895 (1.4mm)	Pervazlı Kasa Profili	1,569 kg/m	32,90	12,65	
	2651/52 (1.4mm)	Geniş Orta Kayıt Profili	1,492 kg/m	20,10	16,6	
	2651/52 (1.6mm)	Geniş Orta Kayıt Profili	1,628 kg/m	21,63	16,70	
	2651/52 (1.8mm)	Geniş Orta Kayıt Profili	1,700 kg/m	23,44	18,13	
	2933/34 (1.6mm)	Baza Orta Kayıt Profili	2,038 kg/m	47,83	28,20	













★ Yandaki profil birim ağırlıkları, bilgisayarda hesaplanmış teorik ağırlıklardır.

PROFİL KESİTİ	PROFİL KODU	PROFİL ADI	AĞIRLIK	ATALET MOMENTLERİ		SAYFA NO
				J_x (cm ⁴)	J_y (cm ⁴)	
	3144	60'lık Yatay Profil	1,424 kg/m	35,84	16,01	
	2972	86'lık Yatay Profil	1,671 kg/m	76,53	21,33	
	4127	106'lık Yatay Profil	1,858 kg/m	121,48	25,36	
	4128	126'lık Yatay Profil	2,042 kg/m	179,98	29,33	
	4129	146'lık Yatay Profil	2,227 kg/m	253,36	33,30	
	4130	156'lık Yatay Profil	2,570 kg/m	322,48	39,74	
	1976	Düşey-Yatay Profil (Tek Cam)	1,757 kg/m	62,47	21,69	
	1977	Düşey-Yatay Profil (Tek Cam)	1,756 kg/m	93,76	23,30	
	4151	Köşe Taşıyıcı Profili	2,825 kg/m	67,59	134,66	
	3138	90 Köşe Dönüş	2,526 kg/m	124,23	78,05	
	2019	Kapak Altı Profili	0,430 kg/m	
	3060	Kapak Altı Profili	0,531 kg/m	
	2020	Kapak Profili	0,333 kg/m	
	4132	Kapak Profili	0,278 kg/m	

★ Yandaki profil birim ağırlıkları, bilgisayarda hesaplanmış teorik ağırlıklardır.

PROFİL KESİTİ	PROFİL KODU	PROFİL ADI	AĞIRLIK	ATALET MOMENTLERİ		SAYFA NO
				J_x (cm ⁴)	J_y (cm ⁴)	
	2021	Kapak Profil	0,271 kg/m	
	2018	Kapak Profili	0,371 kg/m	
	3059	Kapak Profili	1,143 kg/m	
	3763	Kapak Profili	0,965 kg/m	
	4134	90° İç Köşe Adaptör Profili	0,964 kg/m	
	4135	90° İç Köşe Kapak Altı Profili	0,397 kg/m	
	4136	90° İç Köşe Kapak Profili	0,289 kg/m	
	4137	90° İç Köşe Taşıyıcı Adaptör Profili	0,142 kg/m	
	4138	90° Dış Köşe Kapak Altı Profili	0,785 kg/m	
	4139	90° Dış Köşe Kapak Profili	0,821 kg/m	
	1735	Gizli Kanat Profili	0,953 kg/m	15,28	2,29	
	1725	Gizli Kasa Profili	1,243 kg/m	44,57	4,06	
	4140	Bonding Tij Profili	0,112 kg/m	
	4141	Cam Taşıyıcı Profili	0,114 kg/m	







★ Yandaki profil birim ağırlıkları, bilgisayarda hesaplanmış teorik ağırlıklardır.

PROFİL KESİTİ	PROFİL KODU	PROFİL ADI	AĞIRLIK	ATALET MOMENTLERİ		SAYFA NO
				J_x (cm ⁴)	J_y (cm ⁴)	
	877	İspanyolet Çubuğu	0,128 kg/m	
	4143/44	Duvar Bitiş Profili	1,031 kg/m	
	4145/46	Gizli Kasa Profili	1,188 kg/m	21,79	15,17	
	4148	Cam Taşıyıcı Profili	0,187 kg/m	
	4147	Tek Cam Çıtası	0,231 kg/m	
	4149	90° Dış Köşe Taşıyıcı Ek Profili	0,202 kg/m	
	2964	Silikon Cephe Kanat Profili	0,960 kg/m	11,51	3,61	
	4150	Kompozit Kaset Profili	0,685 kg/m	9,17	0,9	
	3090	Bağlantı Profili	0,204 kg/m	
	3231	Kaset Takozu-Üst	0,413 kg/m	
	3232	Kaset Takozu-Alt	0,459 kg/m	
	4142	Bitiş Profili	0,459 kg/m	
	1287	Kompozit Kaset Profili	0,590 kg/m	7,65	0,60	
	1401	Kasa Profili	0,586 kg/m	6,46	1,34	

★ Yandaki profil birim ağırlıkları, bilgisayarda hesaplanmış teorik ağırlıklardır.

PROFİL KESİTİ	PROFİL KODU	PROFİL ADI	AĞIRLIK	ATALET MOMENTLERİ		SAYFA NO
				J_x (cm ⁴)	J_y (cm ⁴)	
	1302	Slikon Cephe Kasa Profili	0,831 kg/m	12,46	1,33	
	1403	Gizli Kanat Profili	1,414 kg/m	57,52	5,31	
	2707	Gizli Kasa Profili	0,821 kg/m	
	1204	Slikon Cephe Bağlantı	0,278 kg/m	
	1402	Baskı Çıtası	0,524 kg/m	
	1513	17*25mm Kutu Profili	0,411 kg/m	
	2962	U Profili	0,357 kg/m	
	2961	Omega Profili	0,992 kg/m	
	1207	Yatay Bağlantı Profili	1,611 kg/m	
	3078	Cephe Bağlantısı	0,959 kg/m	
	4152	Yatay Bağlantı Profili	1,445 kg/m	
	4153	Yatay Bağlantı Profili	0,218 kg/m	
	2926	64'lük Dilatasyon	1,138 kg/m	
	2927	86'lük Dilatasyon	1,376 kg/m	



★ Yandaki profil birim ağırlıkları, bilgisayarda hesaplanmış teorik ağırlıklardır.

PROFİL KESİTİ	PROFİL KODU	PROFİL ADI	AĞIRLIK	ATALET MOMENTLERİ		SAYFA NO
				J_x (cm ⁴)	J_y (cm ⁴)	
	3139	Dilatasyon Profili	2,084 kg/m	
	3140	Dilatasyon Profili	2,231 kg/m	
	4494	Dilatasyon Profili	6,632 kg/m	
	3091	Köşe Takoğu	4,307 kg/m	
	2892	Köşe Takoğu	2,829 kg/m	
	3429	Köşe Takoğu	4,569 kg/m	





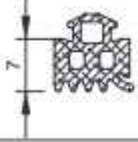
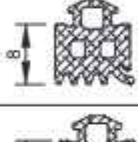
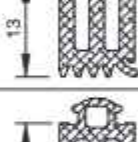
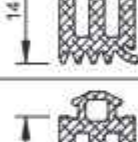
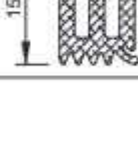

★ Yandaki profil birim ağırlıkları, bilgisayarda hesaplanmış teorik ağırlıklardır.

AKSESUAR KESİTİ	AKSESUAR KODU	AKSESUAR ADI	AĞIRLIK	PAKETLEME	SAYFA NO
	HL01	Dış Cam Fiteli	60 gr/m	15 kg/ 250m	
	HL12	Cephe Fiteli	57 gr/m	15 kg/ 260m	
	HL36	Cam Fiteli	96 gr/m	15 kg/ 156m	
	HL87	Kasa Dış Fiteli	46 gr/m	15 kg/ 300m	
	HL44	Açılı Fiteli	85 gr/m	15 kg/ 176m	
	HL117	Baskı Fiteli	32 gr/m	15 kg/ 468m	
	HL75	Açılı Fiteli	92 gr/m	15 kg/ 163m	
	HL53	Gaga Fiteli	171 gr/m	15 kg/ 90m	
	HL51	5.5 Yatay Fitel	75 gr/m	15 kg/ 200m	
	HL52	9.5 Düşey Fitel	107 gr/m	15 kg/ 140m	
	HL54	Kaset Toz Fiteli	42 gr/m	15 kg/ 357m	
	HL31	Kama Fiteli	37 gr/m	15 kg/ 375m	
	HL76	Cam Fiteli	61 gr/m	15 kg/ 245m	
	HL77	Cam Fiteli	66 gr/m	15 kg/ 227m	
	HL78	Cam Fiteli	72 gr/m	15 kg/ 208m	









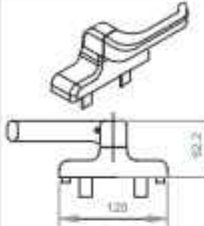
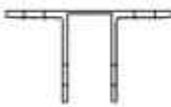

★ Yandaki profil birim ağırlıkları, bilgisayarda hesaplanmış teorik ağırlıklardır.

AKSESUAR KESİTİ	AKSESUAR KODU	AKSESUAR ADI	AĞIRLIK	PAKETLEME	SAYFA NO
	HL79	Cam Fiteli	83 gr/m	15 kg/ 180m	
	HL80	Cam Fiteli	93 gr/m	15 kg/ 161m	
	HL81	Cam Fiteli	107 gr/m	15 kg/ 140m	
	HL56	Cam Fiteli	107 gr/m	15 kg/ 140m	
	HL82	Cam Fiteli	120 gr/m	15 kg/ 125m	
	HL83	Cam Fiteli	126 gr/m	15 kg/ 119m	
	HL84	Cam Fiteli	130 gr/m	15 kg/ 115m	
	HL85	Cam Fiteli	141 gr/m	15 kg/ 106m	
	HL86	Cam Fiteli	149 gr/m	15 kg/ 100m	

★ Yandaki profil birim ağırlıkları, bilgisayarda hesaplanmış teorik ağırlıklardır.

AKSESUAR KESİTİ	AKSESUAR KODU	AKSESUAR ADI	PAKETLEME	SAYFA NO
	HL G 01	43,5 mm Genleşme Contası (2995 nolu profil için)	adet/pk	
	HL G 02	53,5 mm Genleşme Contası (3057,3144 nolu profil için)	adet/pk	
	HL G 03	79,5 mm Genleşme Contası (2972,4126 nolu profil için)	adet/pk	
	HL G 04	99,5 mm Genleşme Contası (3058,4127 nolu profil için)	adet/pk	
	HL G 05	119,5 mm Genleşme Contası (4128 nolu profil için)	adet/pk	
	HL G 06	139,5 mm Genleşme Contası (4129 nolu profil için)	adet/pk	
	HL G 07	149,5 mm Genleşme Contası (4130 nolu profil için)	adet/pk	

★ Yandaki profil birim ağırlıkları, bilgisayarda hesaplanmış teorik ağırlıklardır.

AKSESUAR KESİTİ	AKSESUAR KODU	AKSESUAR ADI	AĞIRLIK	PAKETLEME	SAYFA NO
	05007	Kıvrık Cephe Kolu	
	MP60-05/60 MP60-05/80 MP60-05/100 MP60-05/120 MP60-05/150	Ankraj	
	01269000K	Kanat Karşılığı	
	MP60-10/5	M8 Somun	
	MP60-10/5-1	M8 Pul	
	MP60-08 MP60-10	Klipsli Dübel (M10X100-M10X110) Saplama M10x90	
	GS HD10-28	Cephe Makası	
	MP60-09	M10X85 Gömleklili Dübel M10X110	
	MP32-09/C3-1	Borullu Cephe Kol	...	1 Adet	
	MP32-03/5	Dış Cephe Kolu	...	1 Adet	
	MP32-03	Dış Açılım Kanat Kolu	...	50 Ad/ Paket	

2499
Düsey Taşıyıcı Profil (50)
1,628 kg/m
$J_x=30,34 \text{ cm}^4$ $J_y=16,66 \text{ cm}^4$

2435
Düsey Taşıyıcı Profil (80)
1,920 kg/m
$J_x=77,71 \text{ cm}^4$ $J_y=22,94 \text{ cm}^4$

★ Yandaki profil birim ağırlıkları, bilgisayarla hesaplanmış teorik ağırlıklardır.

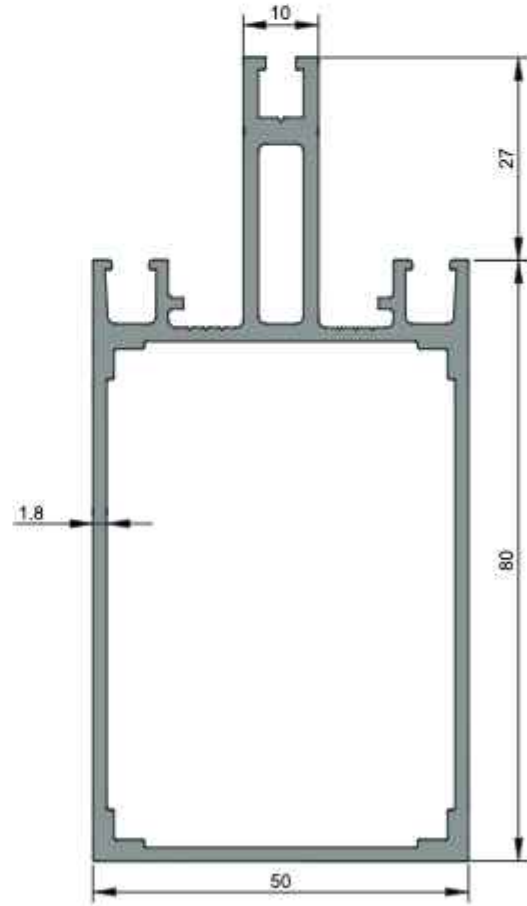
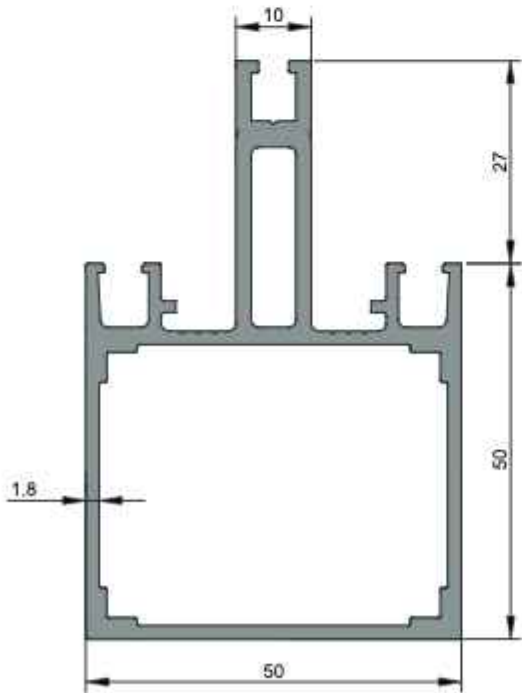

2433

Düşey Taşıyıcı Profil (100)

1,800 kg/m

$J_x=105,92 \text{ cm}^4$ $J_y=22,05 \text{ cm}^4$

3056

Düşey Taşıyıcı Profil (100)

2,001 kg/m

$J_x=117,83 \text{ cm}^4$ $J_y=25,31 \text{ cm}^4$

★ Yandaki profil birim ağırlıkları, bilgisayarda hesaplanmış teorik ağırlıklardır.

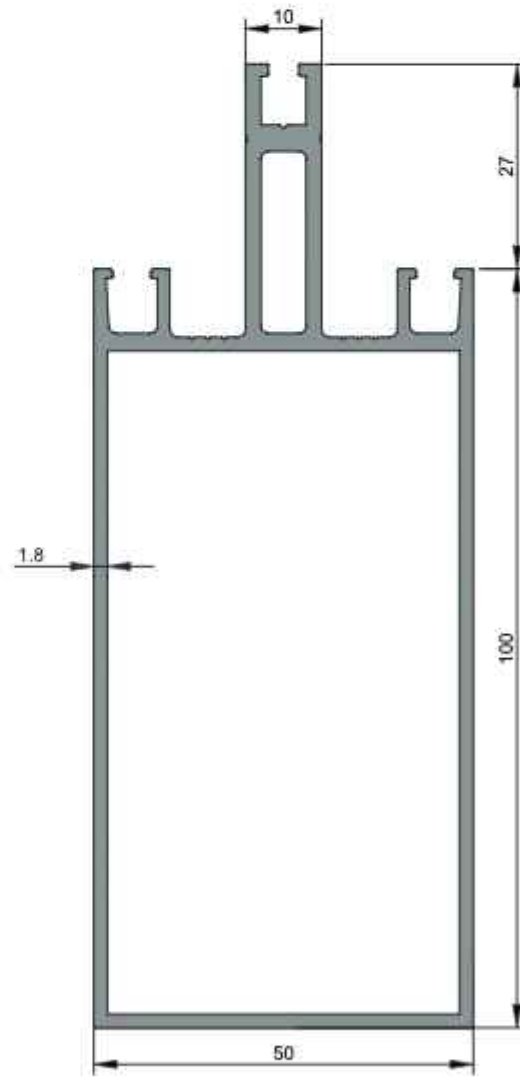
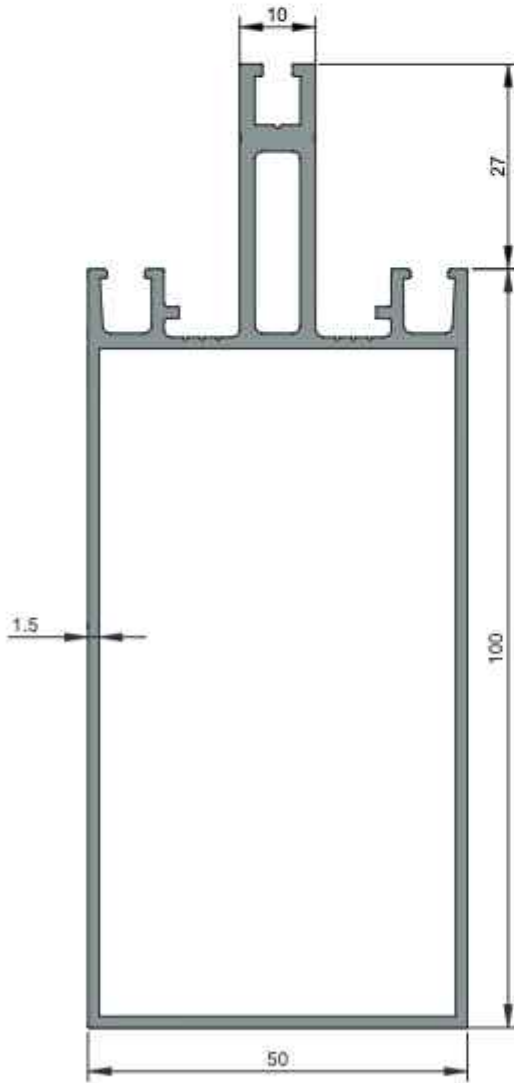

★ Yandaki profil birim ağırlıkları, bilgisayarla hesaplanmış teorik ağırlıklardır.

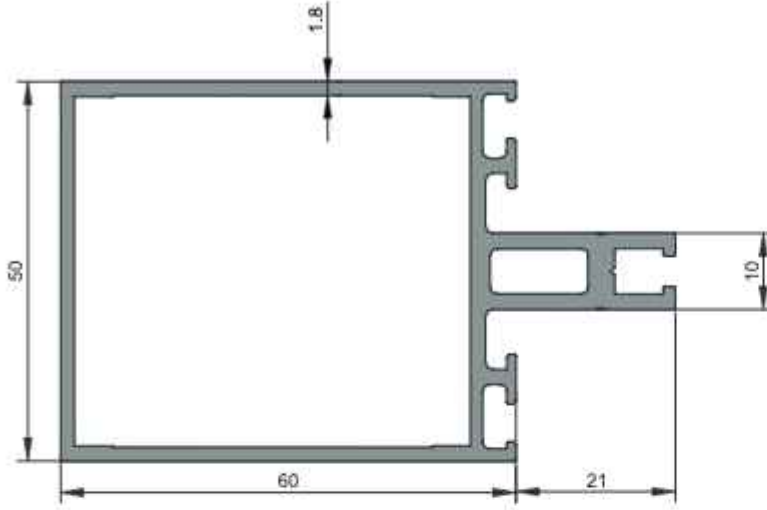

3057
Yatay Taşıyıcı Profil (60)
1,481 kg/m
$J_x=35,90 \text{ cm}^4$ $J_y=16,44 \text{ cm}^4$

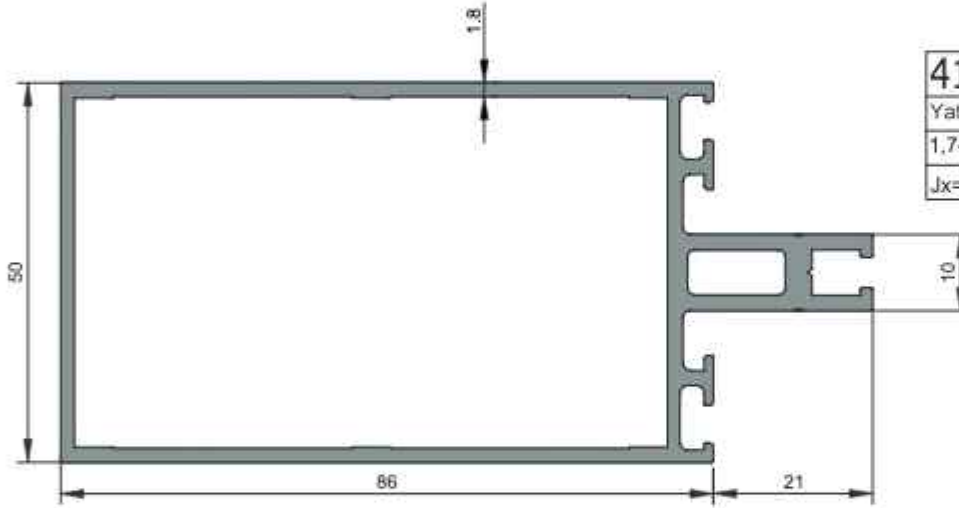

4126
Yatay Taşıyıcı Profil (86)
1,740 kg/m
$J_x=77,92 \text{ cm}^4$ $J_y=21,99 \text{ cm}^4$

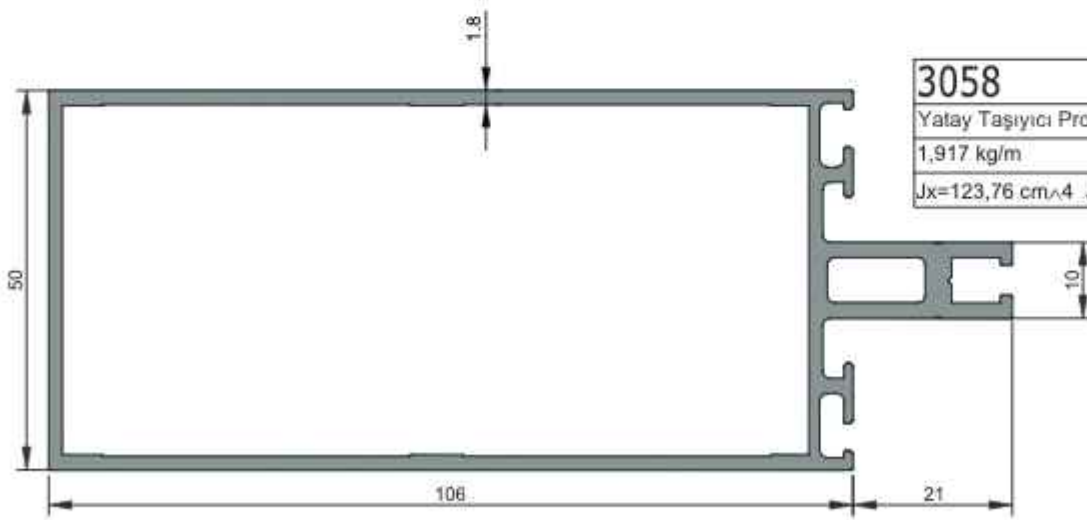

3058
Yatay Taşıyıcı Profil (106)
1,917 kg/m
$J_x=123,76 \text{ cm}^4$ $J_y=26,10 \text{ cm}^4$

2966
Düsey Taşıyıcı Profil (80)
1,815 kg/m
$J_x=73,36 \text{ cm}^4$ $J_y=21,87 \text{ cm}^4$

2967
Düsey Taşıyıcı Profil (100)
2,000 kg/m
$J_x=118,65 \text{ cm}^4$ $J_y=25,84 \text{ cm}^4$

★ Yandaki profil birim ağırlıkları, bilgisayarla hesaplanmış teorik ağırlıklardır.

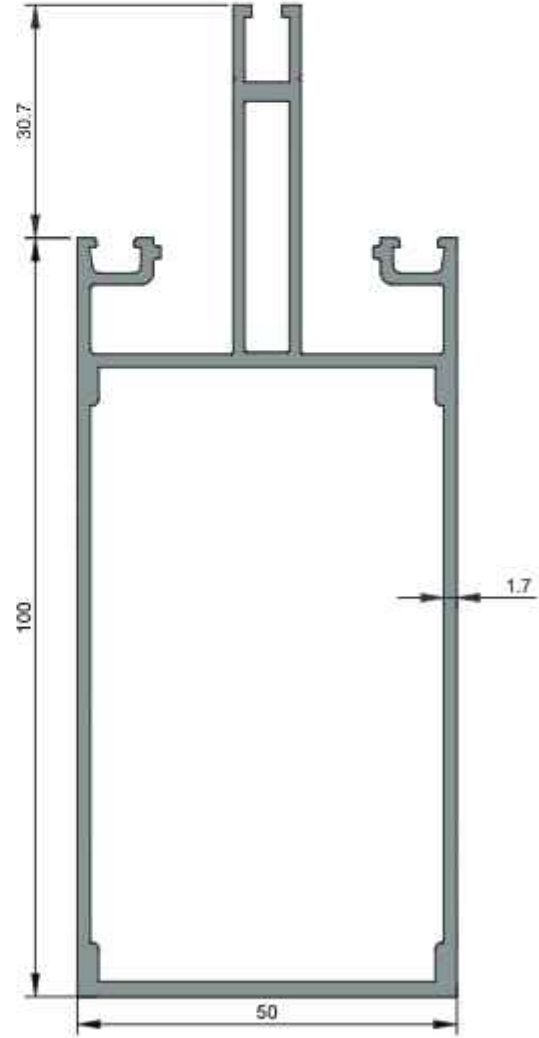
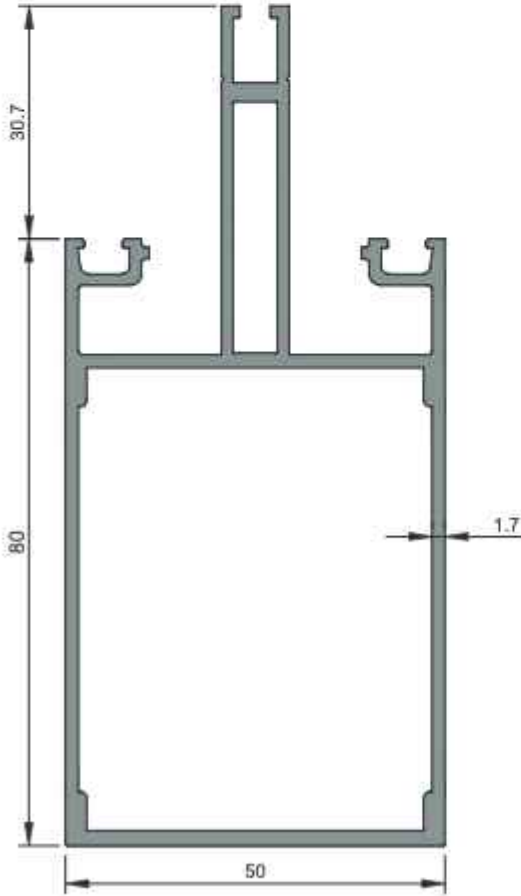

3150
Düşey Taşıyıcı Profil (120)
2,184 kg/m
Jx=178,41 cm ⁴ Jy=29,81cm ⁴

3151
Düşey Taşıyıcı Profil (140)
2,368 kg/m
Jx=254,07 cm ⁴ Jy=33,78 cm ⁴

★ Yandaki profil birim ağırlıkları, bilgisayarla hesaplanmış teorik ağırlıklardır.

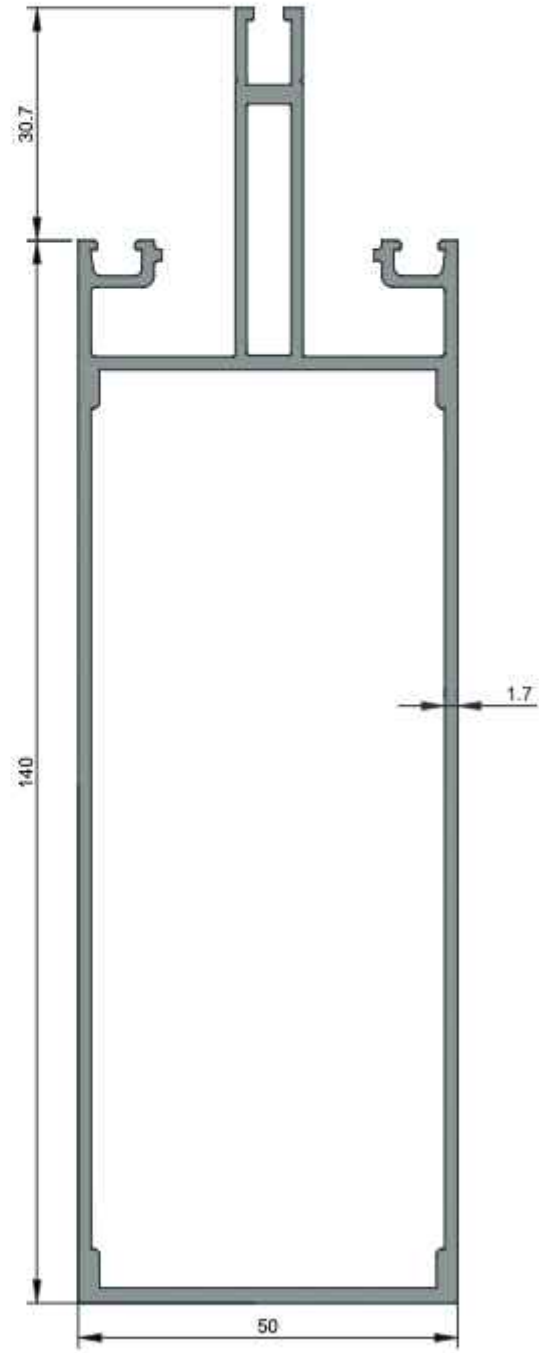
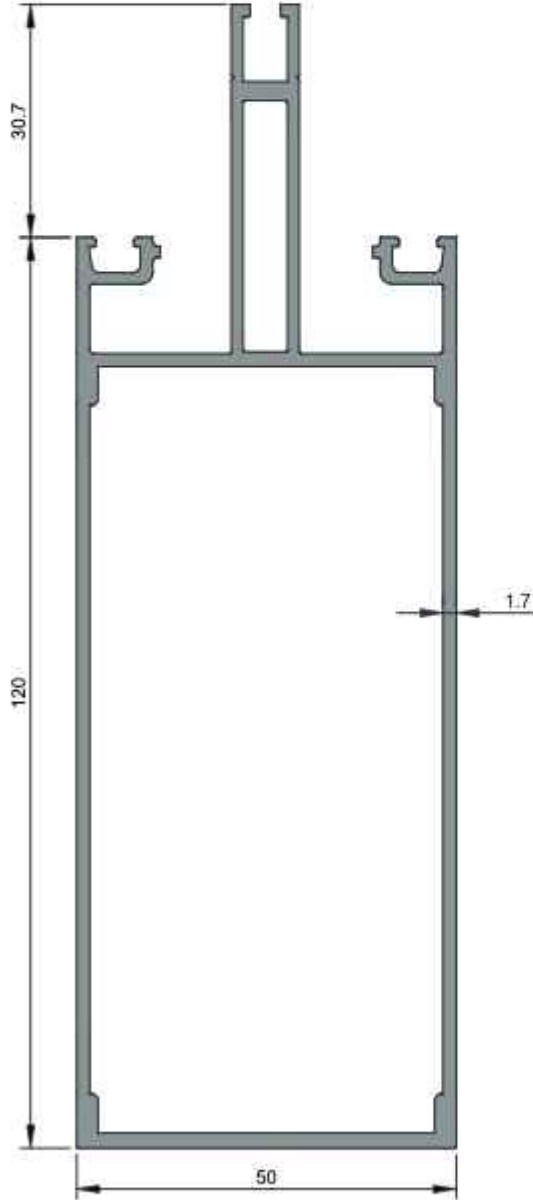

3152
Düşey Taşıyıcı Profil (150)
2,460 kg/m
$Jx=298,30 \text{ cm}^4$ $Jy=35,76 \text{ cm}^4$

4131
Düşey Taşıyıcı Profil (150)
3,316kg/m
$Jx=439,99 \text{ cm}^4$ $Jy=43,92 \text{ cm}^4$

★ Yandaki profil birim ağırlıkları, bilgisayarla hesaplanmış teorik ağırlıklardır.

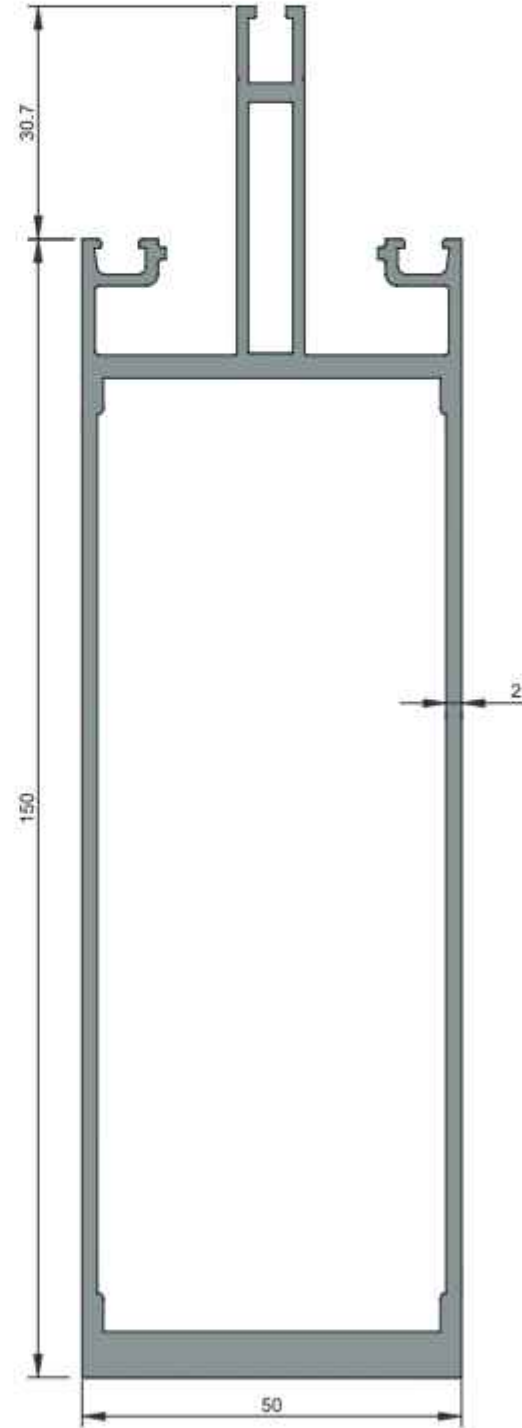
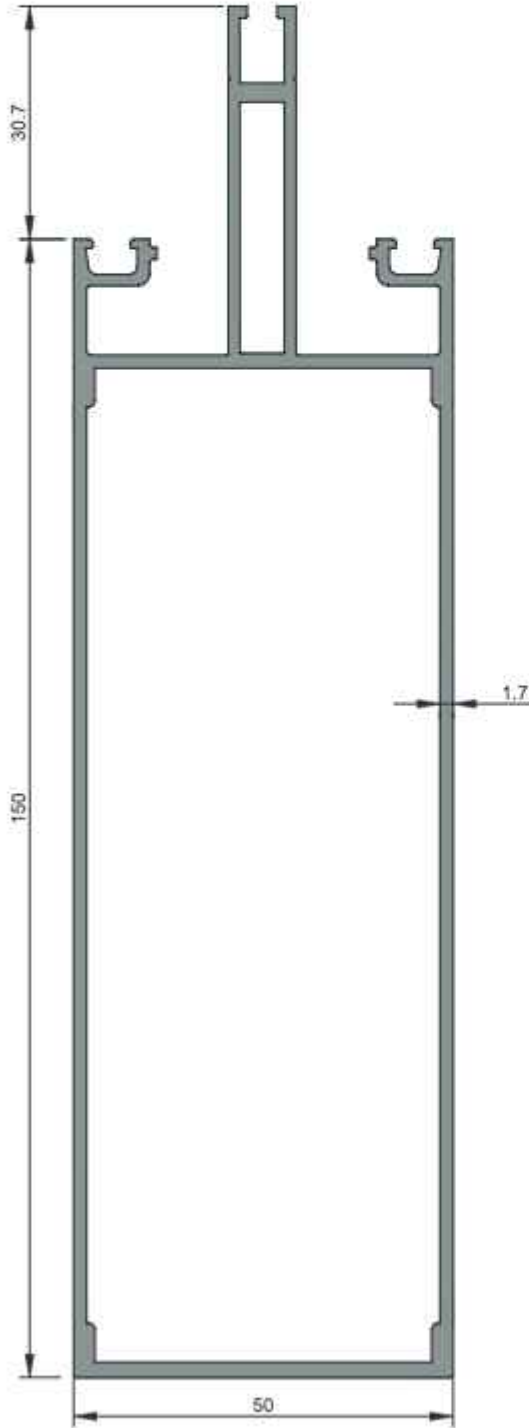

★ Yandaki profil birim ağırlıkları, bilgisayarla hesaplanmış teorik ağırlıklardır.

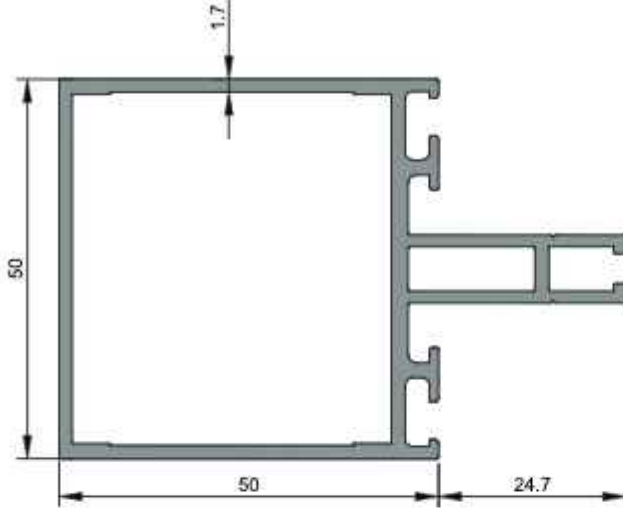

2995

Yatay Taşıyıcı Profil (50)
1,303 kg/m
$J_x=23,67 \text{ cm}^4$ $J_y=14,02 \text{ cm}^4$

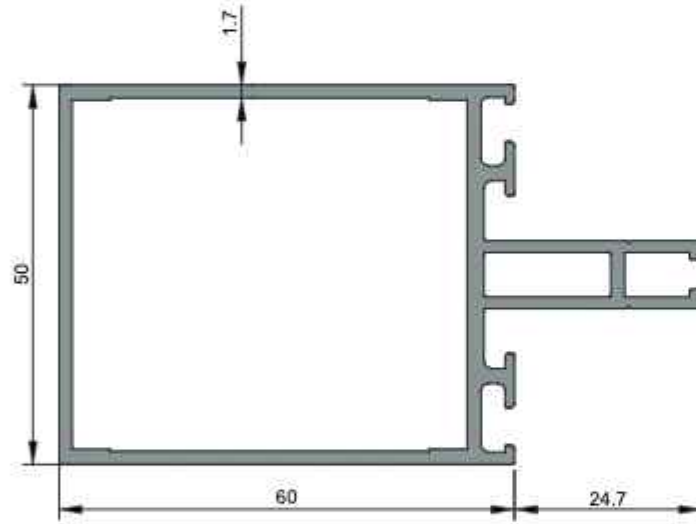

3144

Yatay Taşıyıcı Profil (60)
1,395 kg/m
$J_x=34,15 \text{ cm}^4$ $J_y=16,01 \text{ cm}^4$

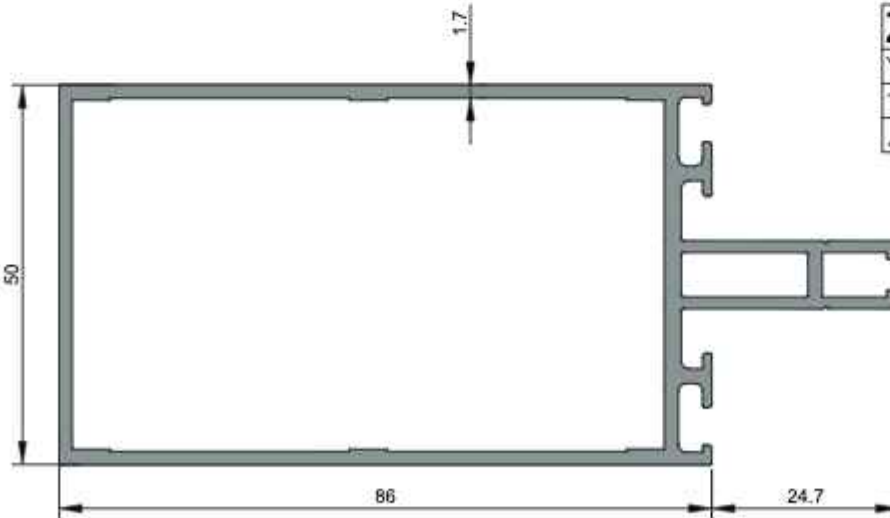

2972

Yatay Taşıyıcı Profil (86)
1,643 kg/m
$J_x=73,83 \text{ cm}^4$ $J_y=21,32 \text{ cm}^4$

★ Yandaki profil birim ağırlıkları, bilgisayarla hesaplanmış teorik ağırlıklardır.

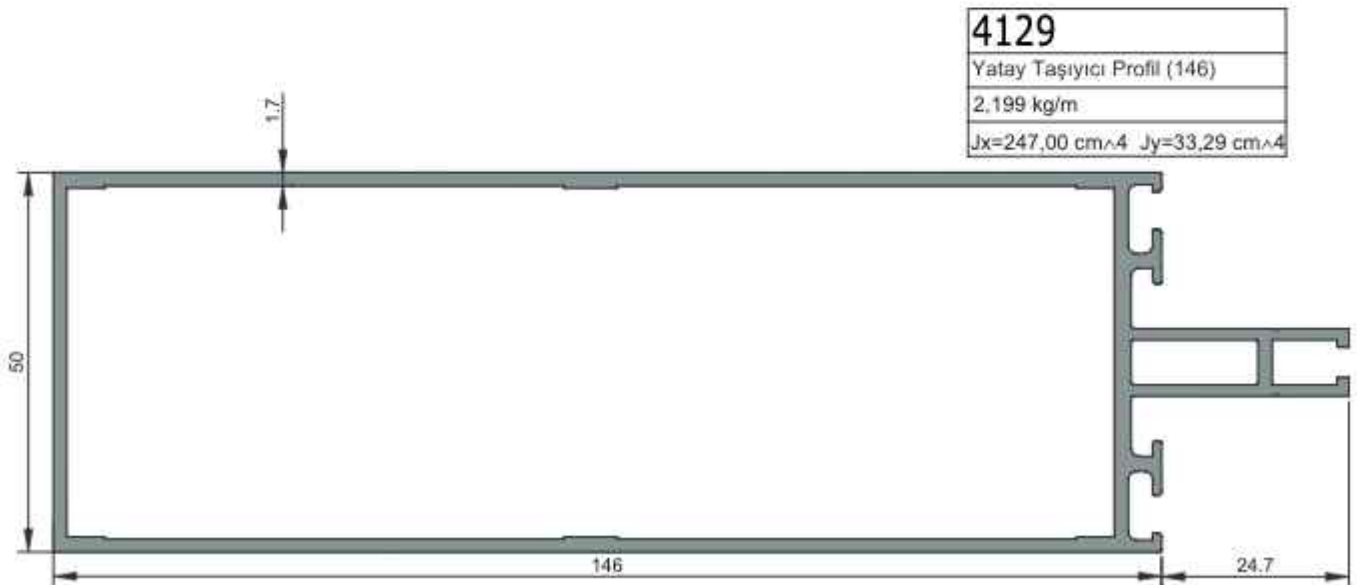
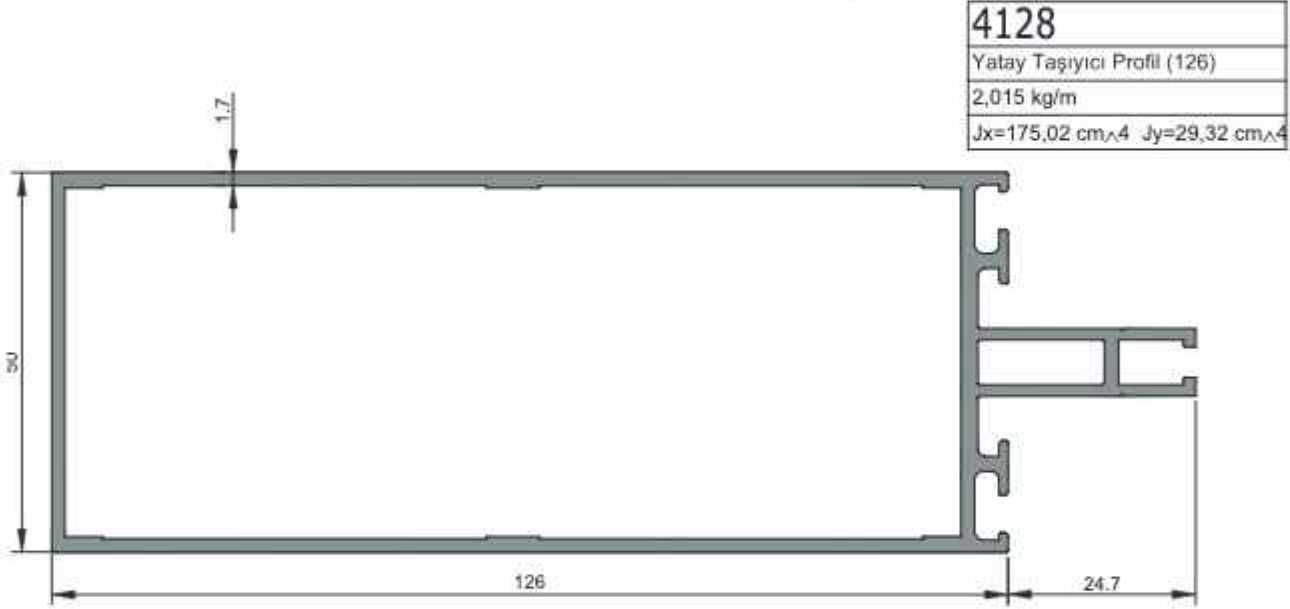
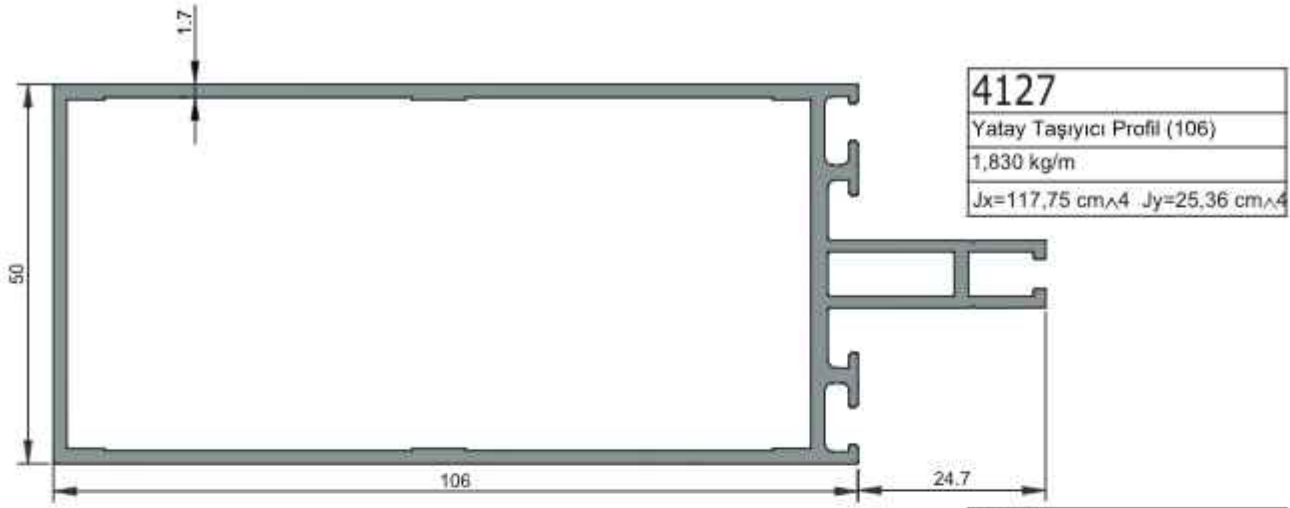

4130

Yatay Taşıyıcı Profil (156)

2,542 kg/m

$J_x=314,86 \text{ cm}^4$ $J_y=39,74 \text{ cm}^4$



★ Yandaki profil birim ağırlıkları, bilgisayarla hesaplanmış teorik ağırlıklardır.

1976
Düsey-Yatay Taşıyıcı Profil (Tek Cam)
1,757 kg/m
$J_x=62,47 \text{ cm}^4$ $J_y=21,69 \text{ cm}^4$

1977
Düsey-Yatay Taşıyıcı Profil (Tek Cam)
1,756 kg/m
$J_x=93,76 \text{ cm}^4$ $J_y=23,30 \text{ cm}^4$

★ Yandaki profil birim ağırlıkları, bilgisayarda hesaplanmış teorik ağırlıklardır.

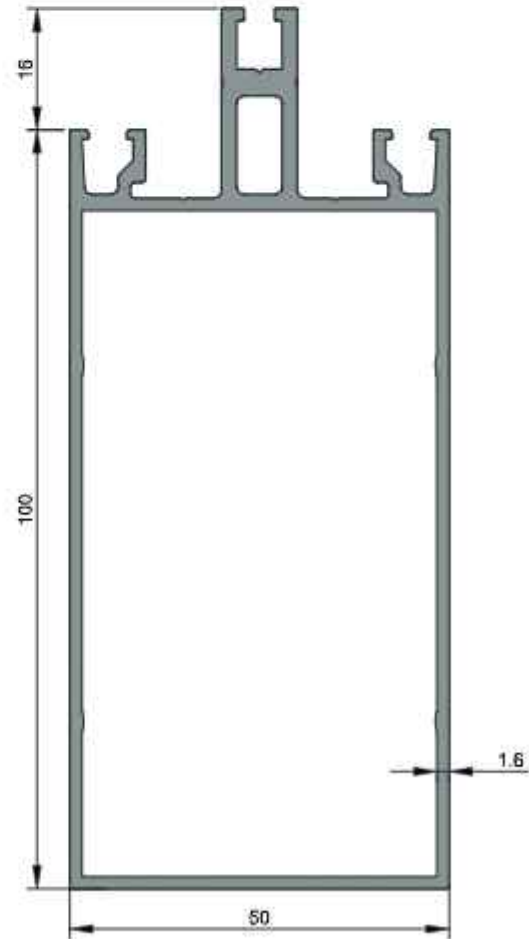
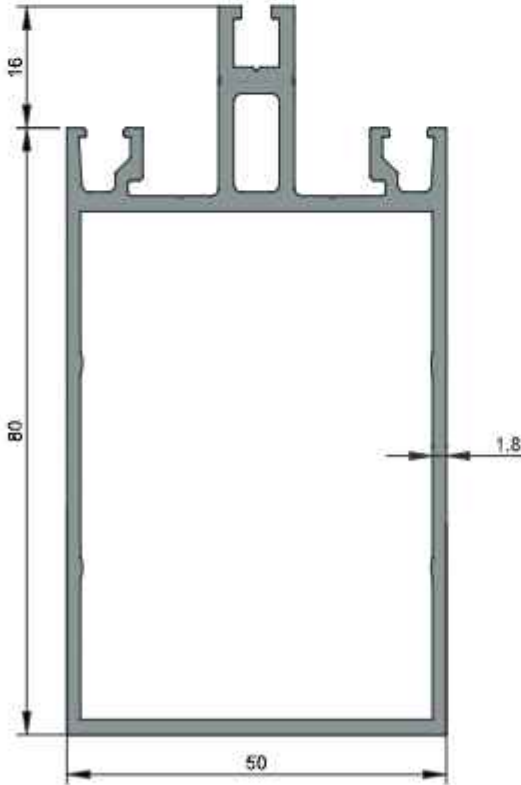

★ Yandaki profil birim ağırlıkları, bilgisayarla hesaplanmış teorik ağırlıklardır.

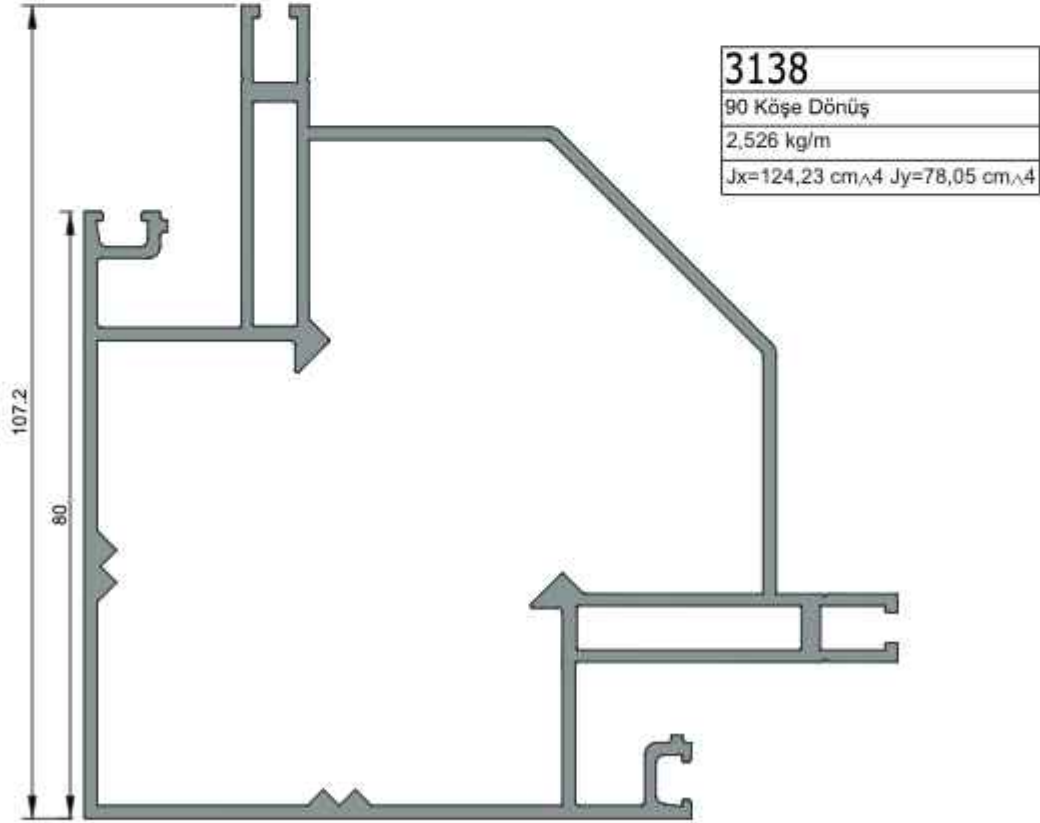
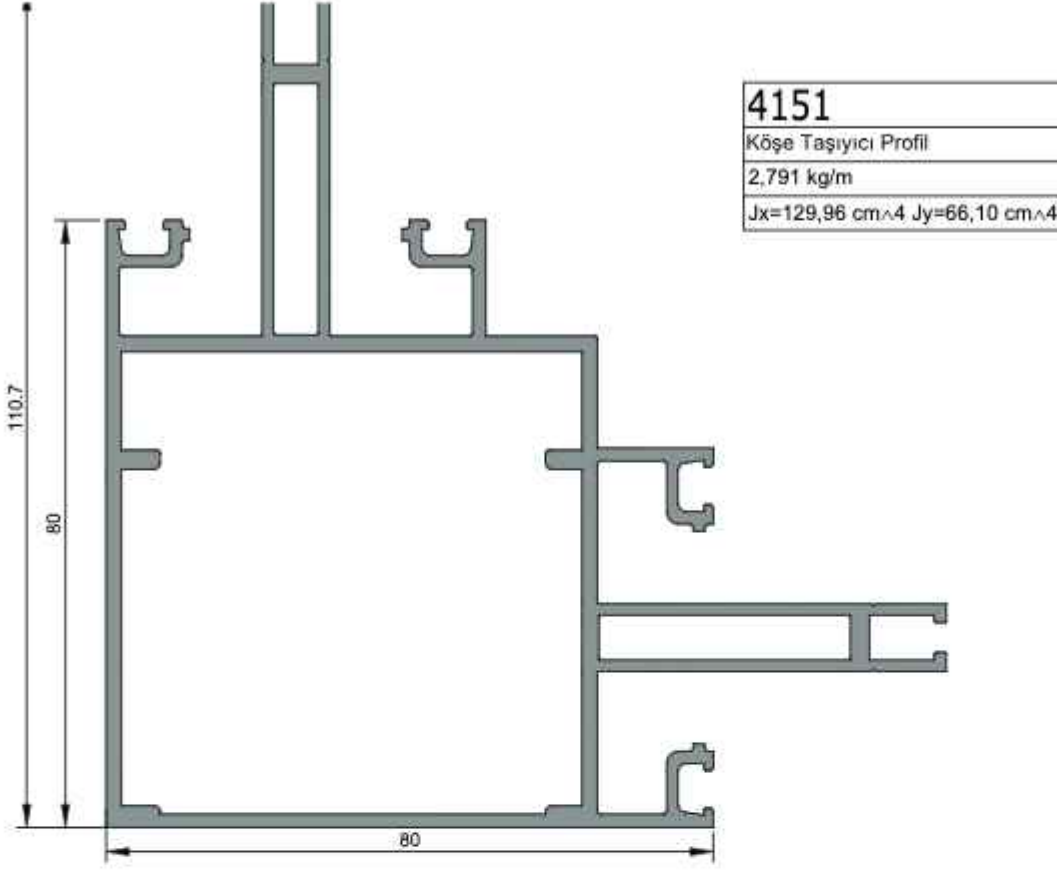

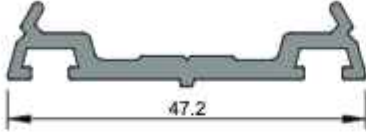

2019

Kapak Altı Profili

0,430 kg/m

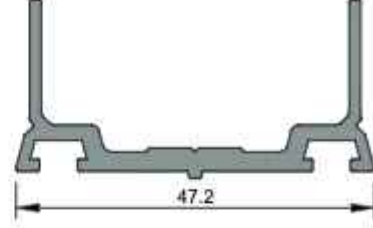

3060

Kapak Altı Profili

0,531 kg/m

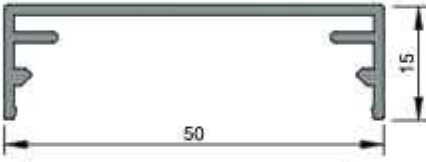

2020

Kapak Profili

0,333 kg/m



4132

Yatay Kapak Profili

0,278 kg/m

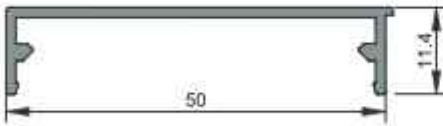

2021

Düz Kapak Profili

0,271 kg/m

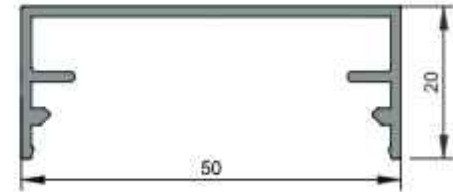

2018

Kapak Profili

0,371 kg/m

★ Yandaki profil birim ağırlıkları, bilgisayarda hesaplanmış teorik ağırlıklardır.

★ Yandaki profil birim ağırlıkları, bilgisayarla hesaplanmış teorik ağırlıklardır.

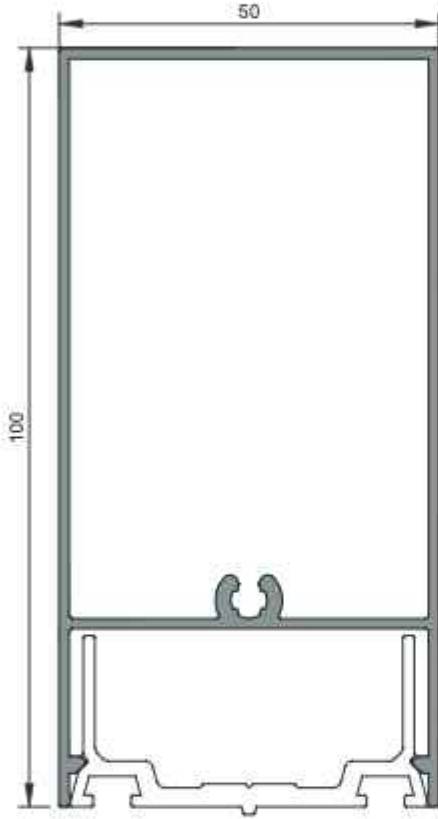

3059

Kapak Profili
1,143 kg/m

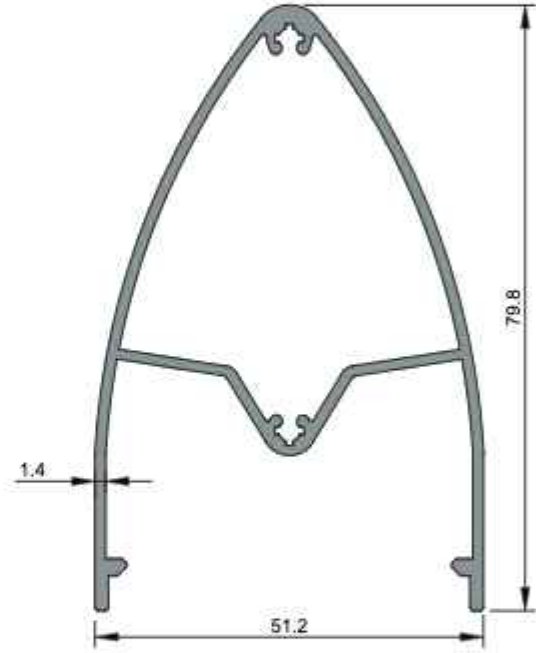

3763

Kapak Profili
0,965 kg/m

★ Yandaki profil birim ağırlıkları, bilgisayarda hesaplanmış teorik ağırlıklardır.

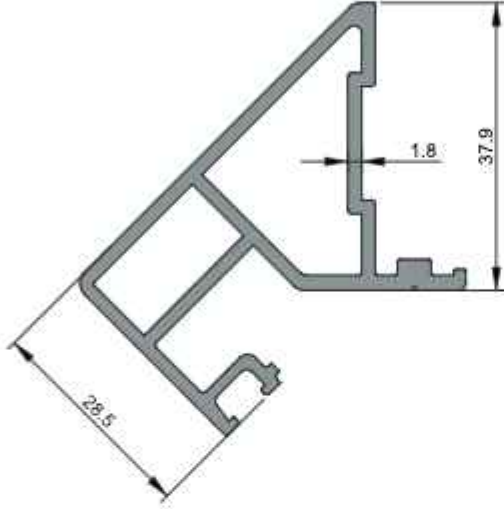

4134
90° İç Köşe Adaptör Profili
0,964 kg/m

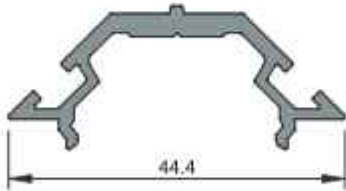

4135
90° İç Köşe Kapak Altı Profili
0,397 kg/m

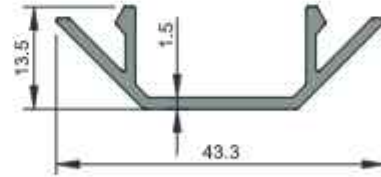

4136
90° İç Köşe Kapak Profili
0,289 kg/m

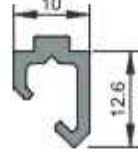

4137

90° Köşe Taşıyıcı Adaptör Profili
0,142 kg/m

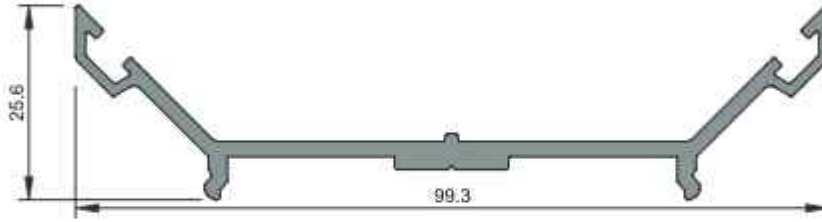

4138

90° Dış Köşe Kapak Altı Profili
0,785 kg/m

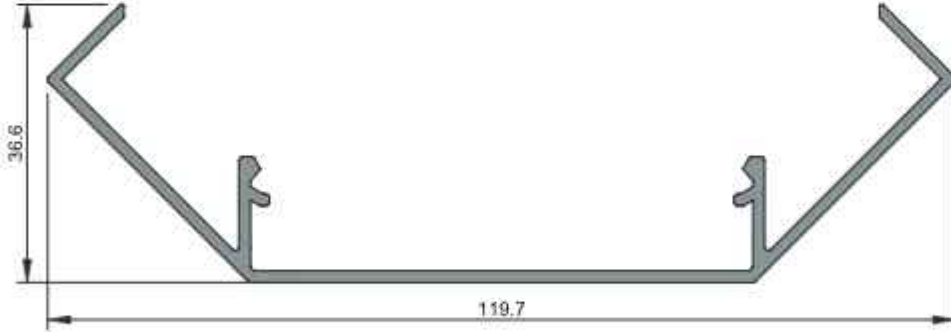

4139

90° Dış Köşe Kapak Profili
0,821 kg/m

★ Yandaki profil birim ağırlıkları, bilgisayarda hesaplanmış teorik ağırlıklardır.

★ Yandaki profil birim ağırlıkları, bilgisayarla hesaplanmış teorik ağırlıklardır.

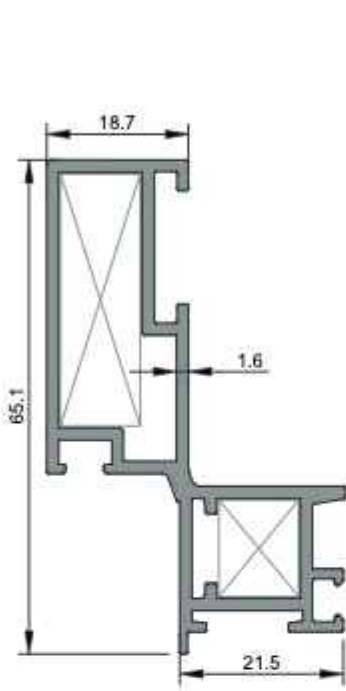

1735
Gizli Kanat Profili
0,953 kg/m
$J_x=15,28 \text{ cm}^4$ $J_y=2,29 \text{ cm}^4$

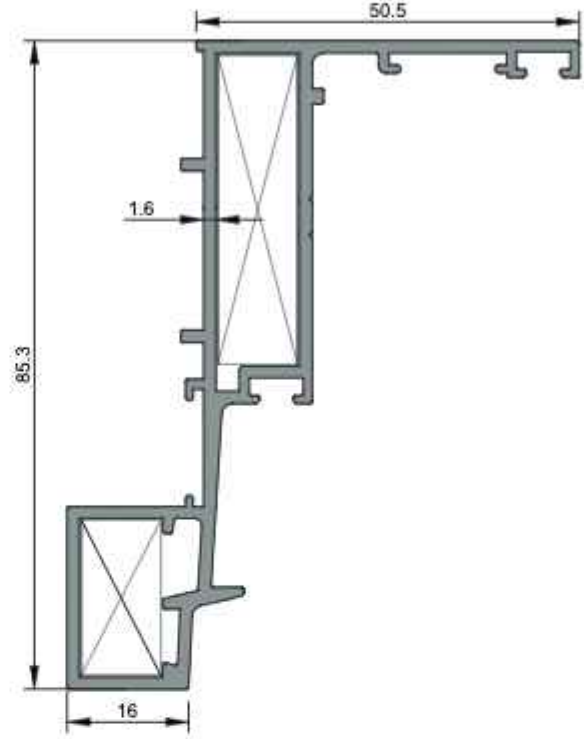

1725
Gizli Kasa Profili
1,243 kg/m
$J_x=44,57 \text{ cm}^4$ $J_y=4,06 \text{ cm}^4$

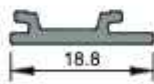

4140
Bonding Tij Profili
0,112 kg/m



4141
Cam Taşıyıcı Profili
0,114 kg/m

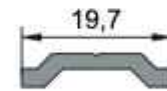

877
İspanyolet Çubuğu
0,128 kg/m

★ Yandaki profil birim ağırlıkları, bilgisayarla hesaplanmış teorik ağırlıklardır.

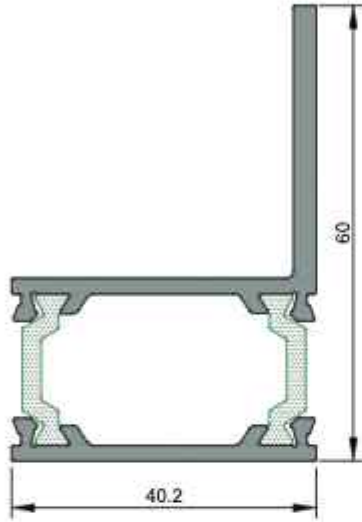

4143/44
Duvar Bitiş Profili
1,031 kg/m

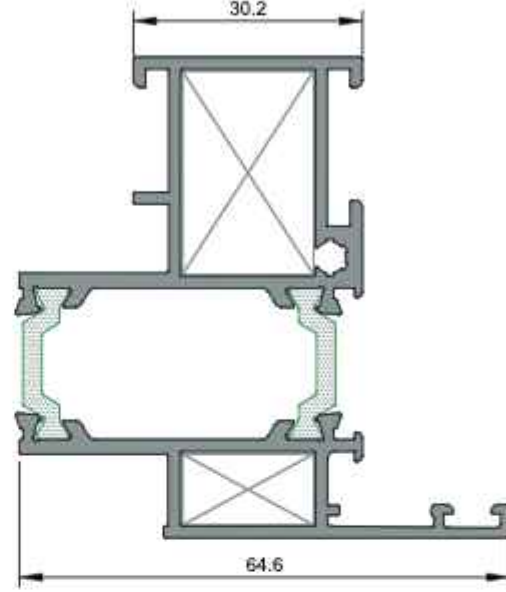

4145/46
Gizli Kasa Profili
1,188 kg/m
$J_x=21,79 \text{ cm}^4$ $J_y=15,17 \text{ cm}^4$

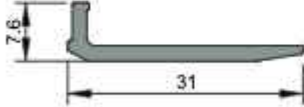

4148
Cam Taşıyıcı Profili
0,187 kg/m

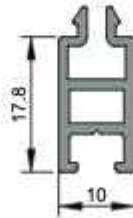

4147
Tek Cam Çıtası
0,231 kg/m

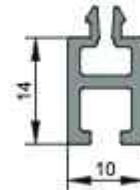

4149
90° Dış Köşe Taşıyıcı Ek Profili
0,202 kg/m

★ Yandaki profil birim ağırlıkları, bilgisayarla hesaplanmış teorik ağırlıklardır.

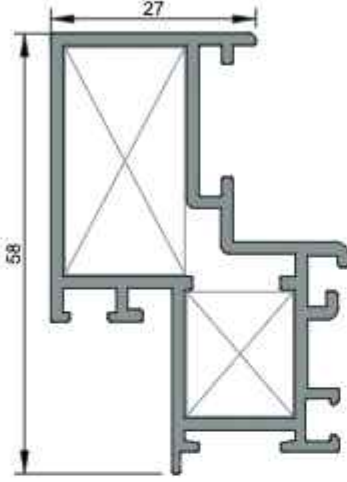

2964

Silikon Cephe Kanat Profili

0,964 kg/m

Jx=11,56 cm⁴ Jy=3,61 cm⁴

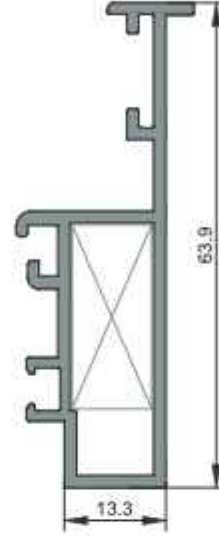

4150

Kompozit Kaset Profili

0,685 kg/m

Jx=9,17 cm⁴ Jy=0,9 cm⁴

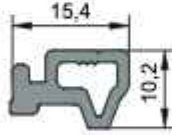

3090

Bağlantı Profili

0,204 kg/m

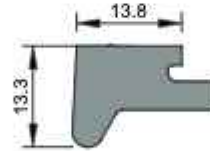

3231

Kaset Takoğu - Üst

0,413 kg/m

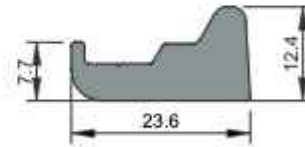

3232

Kaset Takoğu - Alt

0,459 kg/m

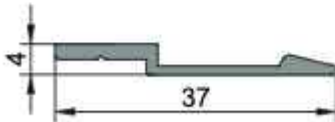

4142

Bitiş Profili

0,165kg/m

★ Yandaki profil birim ağırlıkları, bilgisayarda hesaplanmış teorik ağırlıklardır.

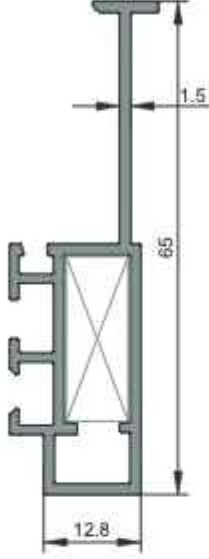

1287
Kompozit Kaset Profili
0,590 kg/m
$J_x=7,65 \text{ cm}^4$ $J_y=0,60 \text{ cm}^4$

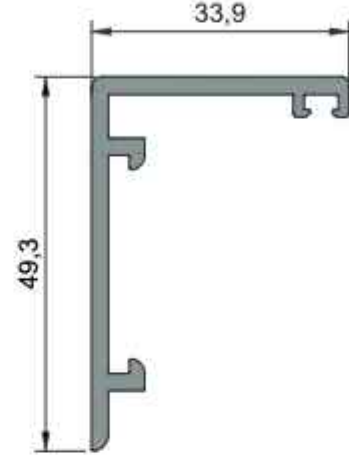

1401
Kasa Profili
0,586 kg/m
$J_x=6,46 \text{ cm}^4$ $J_y=1,34 \text{ cm}^4$

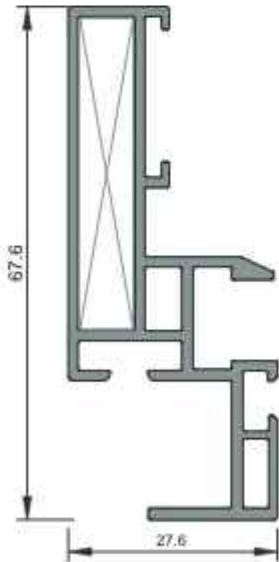

1302
Silikon Cephe Kasa Profili
0,831 kg/m
$J_x=12,46 \text{ cm}^4$ $J_y=1,33 \text{ cm}^4$

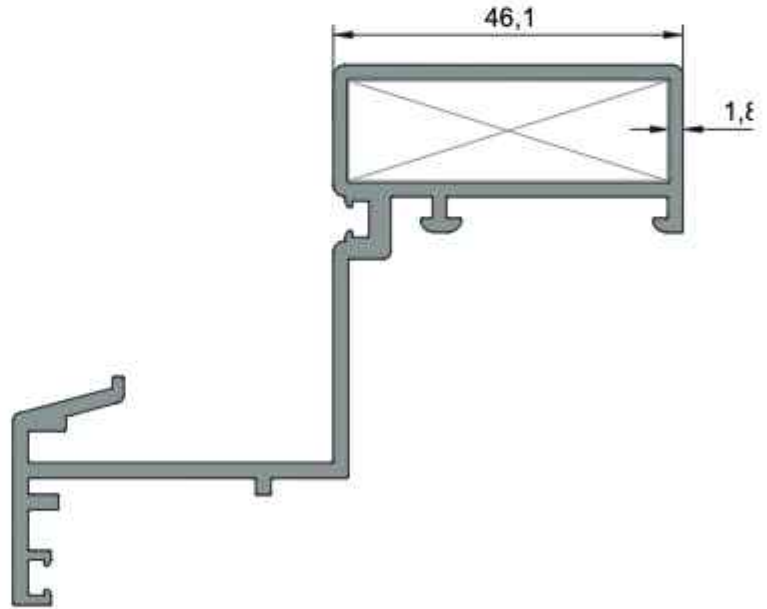

1403
Gizli Kanat Profili
1,414 kg/m
$J_x=57,52 \text{ cm}^4$ $J_y=5,31 \text{ cm}^4$

★ Yandaki profil birim ağırlıkları, bilgisayarda hesaplanmış teorik ağırlıklardır.

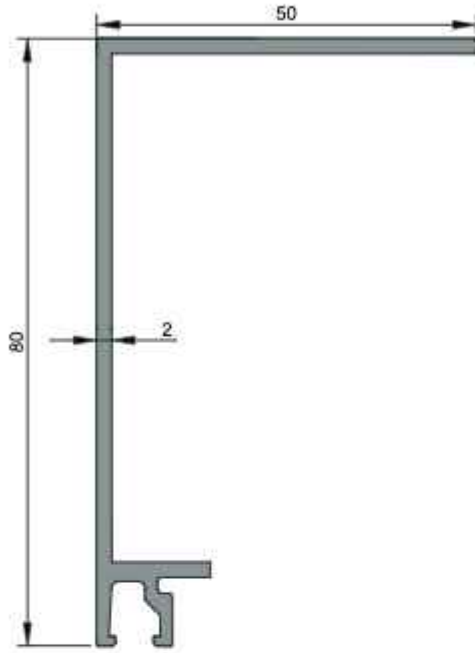

2707
Gizli Kasa Profili
0,821 kg/m

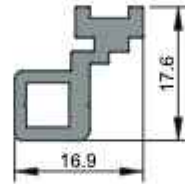

1204
Silikon Cephe Bağlantı
0,278 kg/m

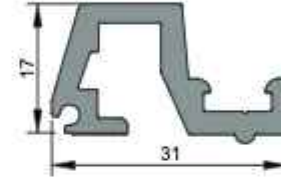

1402
Baskı Çıtası
0,524 kg/m

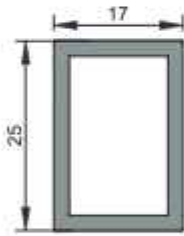

1513
17*25mm Kutu Profili
0,411 kg/m

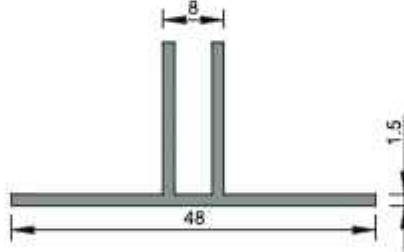

2962
U Profili
0,357 kg/m

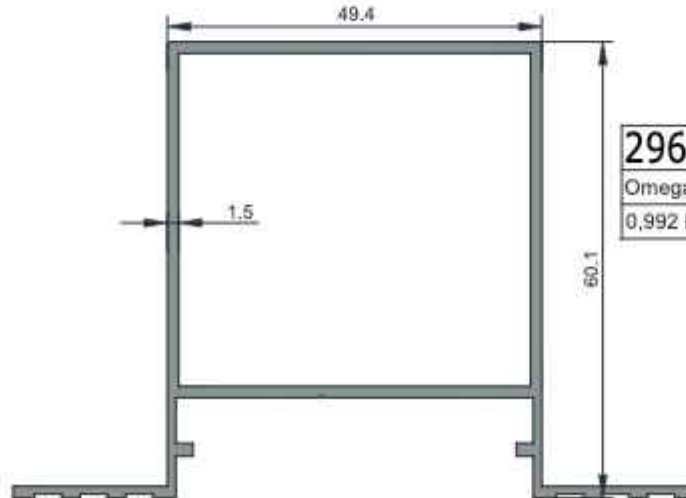

2961
Omega Profili
0,992 kg/m

★ Yandaki profil birim ağırlıkları, bilgisayarla hesaplanmış teorik ağırlıklardır.

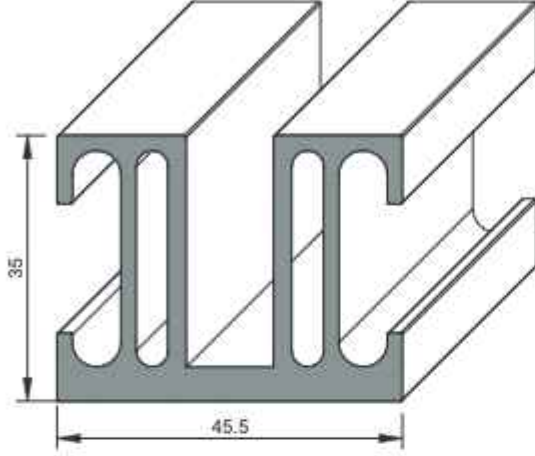

1207

Yatay Bağlantı Profili

1,611 kg/m

Aksesuar Kodu	Profil Kodu	Kesim Ölçüsü A(mm)
B1207 665	1976	66.5
B1207 873	1977	87.3

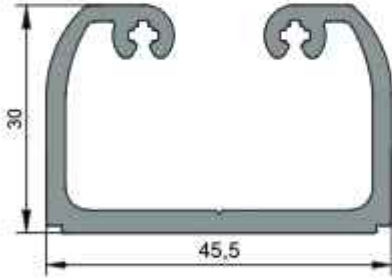

3078

Cephe Bağlantısı

0,959 kg/m

Aksesuar Kodu	Profil Kodu	Kesim Ölçüsü A(mm)
B3078 665	1976	66.5
B3078 873	1977	87.3

★ Yandaki profil birim ağırlıkları, bilgisayarda hesaplanmış teorik ağırlıklardır.

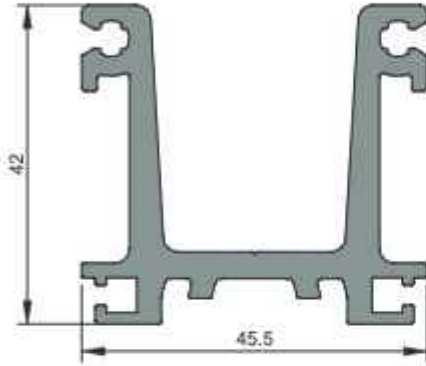

4152
Yatay Bağlantı Profili
1,445 kg/m

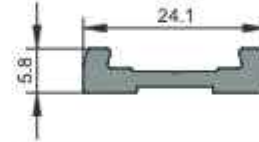

4153
Yatay Bağlantı Profili
0,218 kg/m

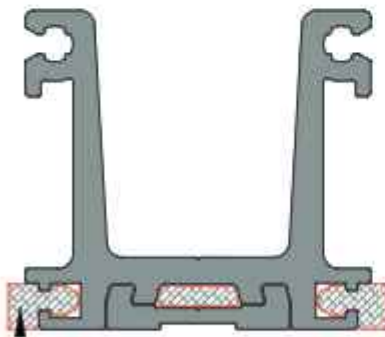

HL G 01
HL G 02
HL G 03
HL G 04
HL G 04
HL G 05
HL G 06
HL G 07

Aksesuar Kodu	Profil Kodu	Kesim Ölçüsü A(mm)
B4152 418	2995	41.8
B4152 518	3144	51.8
B4152 778	2972	77.8
B4152 978	4127	97.8
B4152 1178	4128	117.8
B4152 1378	4129	137.8
B4152 1475	4130	147.5
B4152 517	3057	51.7
B4152 777	4126	77.7
B4152 977	3058	97.7

Aksesuar Kodu	Profil Kodu	Kesim Ölçüsü A(mm)
B4153 418	2995	41.8
B4153 518	3144	51.8
B4153 778	2972	77.8
B4153 978	4127	97.8
B4153 1178	4128	117.8
B4153 1378	4129	137.8
B4153 1475	4130	147.5
B4153 517	3057	51.7
B4153 777	4126	77.7
B4153 977	3058	97.7

★ Yandaki profil birim ağırlıkları, bilgisayarla hesaplanmış teorik ağırlıklardır.

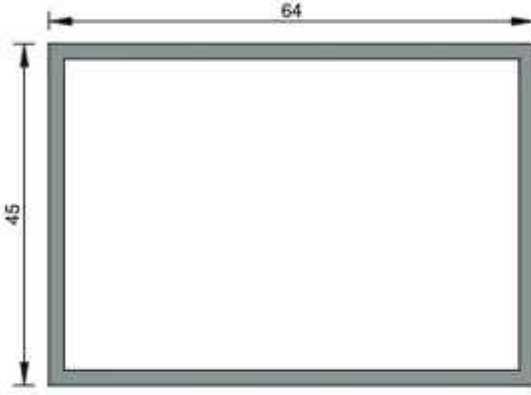

2926
64'lük Dilatasyon
1,138 kg/m

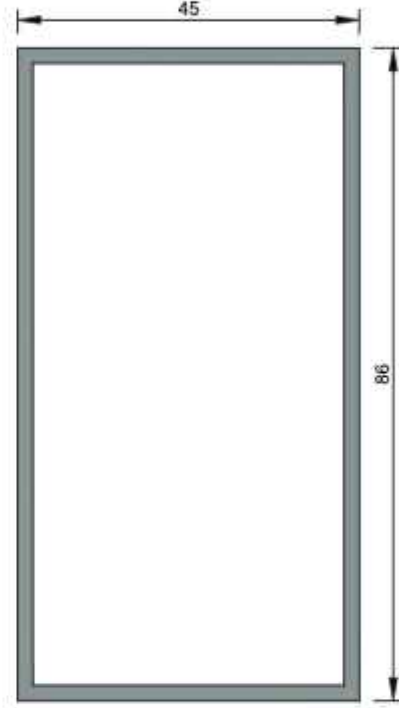

2927
86'lük Dilatasyon
1,376 kg/m

3139

Dilatasyon Profili

2.084 kg/m

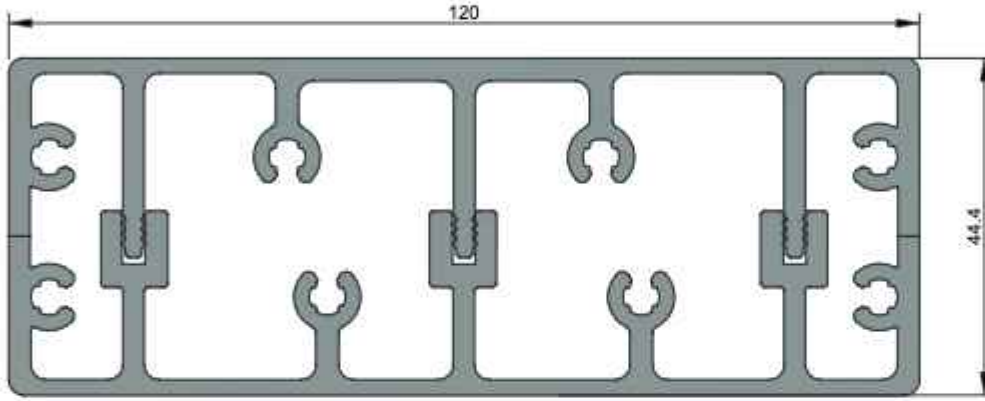

3140

Dilatasyon Profili

2.231 kg/m

Aksesuar Kodu	Profil Kodu	Kesim Ölçüsü A(mm)
D3139/3140 349	2499	34.9
D3139/3140 649	2435	64.9
D3139/3140 875	2433	87.5
D3139/3140 869	3056	86.9
D3139/3140 605	2966	60.5
D3139/3140 805	2967	80.5
D3139/3140 1005	3150	100.5
D3139/3140 1205	3151	120.5
D3139/3140 1305	3152	130.5
D3139/3140 1252	4131	125.2

★ Yandaki profil birim ağırlıkları, bilgisayarda hesaplanmış teorik ağırlıklardır.

★ Yandaki profil birim ağırlıkları, bilgisayarla hesaplanmış teorik ağırlıklardır.

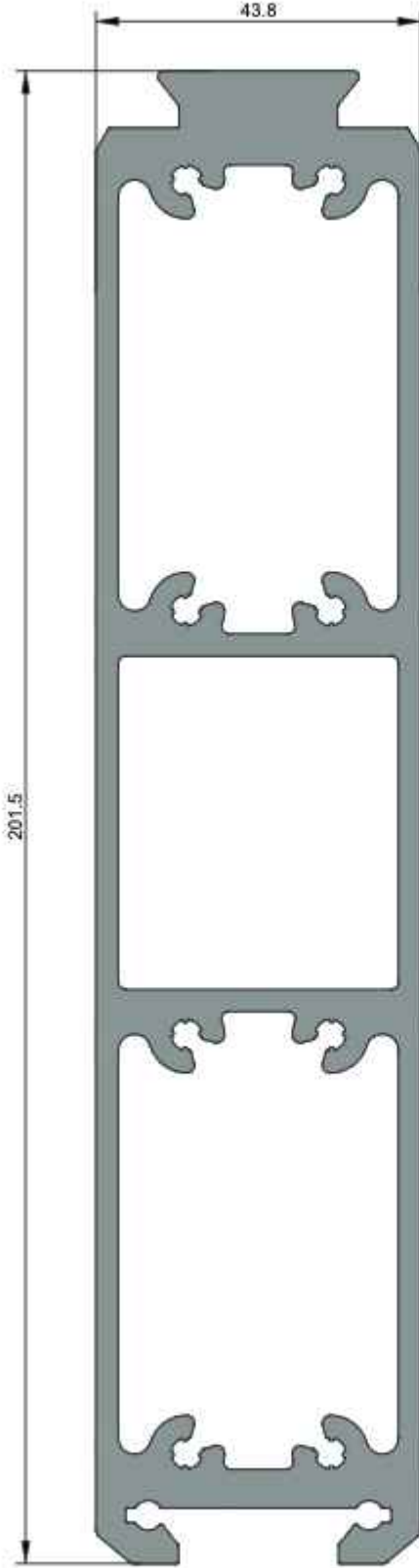

4494
Dilatasyon Profili
6,632 kg/m

Aksesuar Kodu	Profil Kodu	Kesim Ölçüsü A(mm)
D4494 349	2499	34.9
D4494 649	2435	64.9
D4494 875	2433	87.5
D4494 869	3056	86.9
D4494 605	2966	60.5
D4494 805	2967	80.5
D4494 1005	3150	100.5
D4494 1205	3151	120.5
D4494 1305	3152	130.5
D4494 1252	4131	125.2

★ Yandaki profil birim ağırlıkları, bilgisayarda hesaplanmış teorik ağırlıklardır.

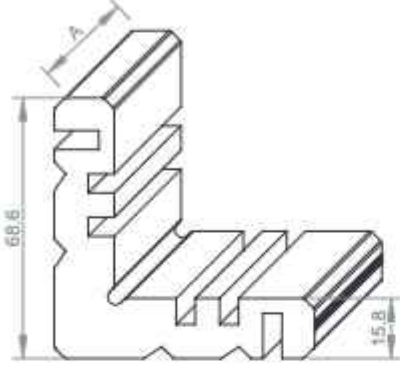

3091
Köşe Takozu
4,307 kg/m

Aksesuar Kodu	Profil Kodu	Kesim Ölçüsü A(mm)
K3091 299	2964	29.9

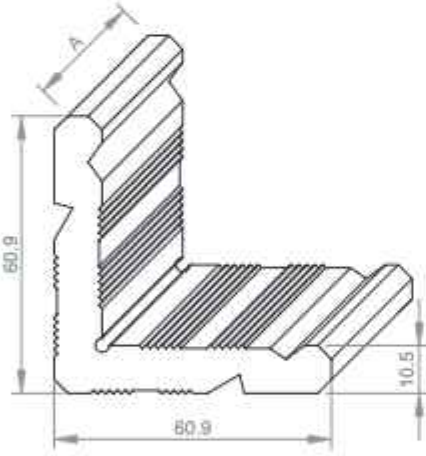

2892
Köşe Takozu
2,829 kg/m

Aksesuar Kodu	Profil Kodu	Kesim Ölçüsü A(mm)
K2892 205	1735	20.5
K2892 408	1735	40.8
K2892 127	1725	12.7
K2892 332	1725	33.2
K2892 243	4150	24.3

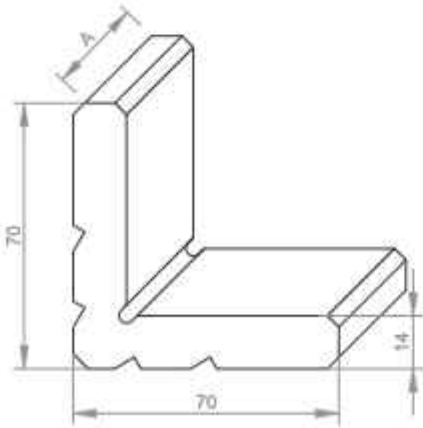

3429
Köşe Takozu
4,569 kg/m

Aksesuar Kodu	Profil Kodu	Kesim Ölçüsü A(mm)
K3429 164	2964	16.4

★ Yandaki profil birim ağırlıkları, bilgisayararda hesaplanmış teorik ağırlıklardır.

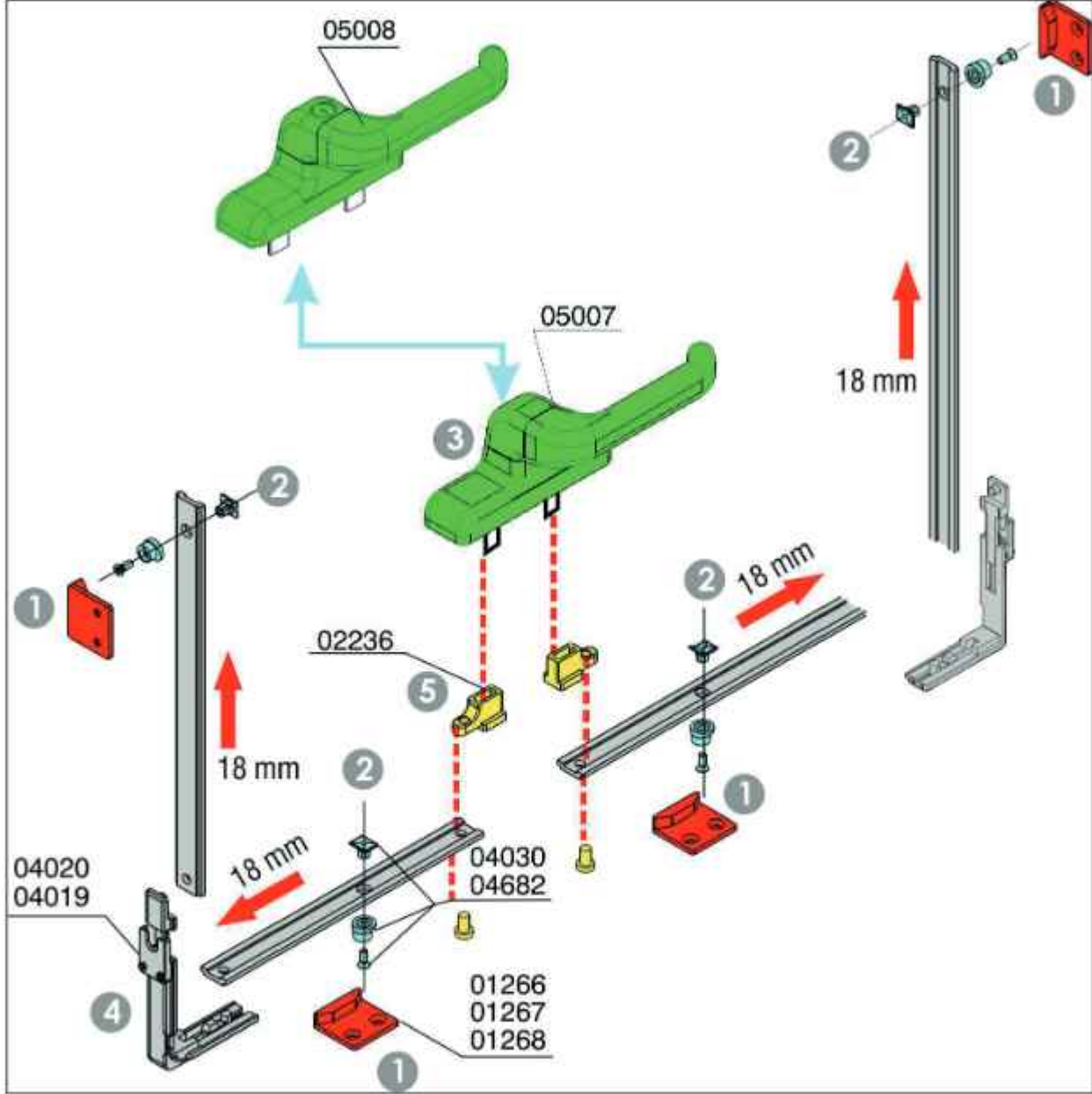

AKSESUAR	
	Kıvrık Pencere Kol
	Makas (... ")
	Ayarlı Pim
	Üst Kilitleme Elemanı
	Bağlantı Elemanı
	Sabit Karşılık
	Köşe Dönme
	Limitleme Makası

★ Yandaki profil birim ağırlıkları, bilgisayarda hesaplanmış teorik ağırlıklardır.

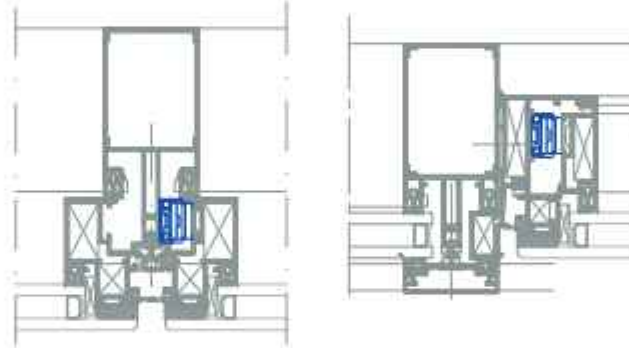

CEPHE MAKAS TİPLERİ

		MAKAS ÖZELLİKLERİ					KANAT ÖLÇÜLERİ		
Ürün Kodu	Makas Tipi	Açılım Şekli	Makas Geniliği (mm)	Çalışma Bölüğü (mm)	Makas Uzunluğu (mm)	Makas Açma Derecesi	Makas Kanat Yüksekliği (mm)	Makas Kanat Geniliği (mm)	Makas Kanat Ağırlığı (kg)
HL 10001	10"	Gizli Kanat	23	16+0,5	261,5	35°	700	1200	50
HL 10002	12"	Gizli Kanat	23	16+0,5	317,5	30° / 35°	800	1200	60
HL 10003	14"	Gizli Kanat	23	16+0,5	353,5	30° / 35°	1000	1300	69,5
HL 10004	16"	Gizli Kanat	23	16+0,5	414,5	25° / 30°	1200	1400	88,5
HL 10005	18"	Gizli Kanat	23	16+0,5	458,5	25° / 30°	1400	1400	102
HL 10006	20"	Gizli Kanat	23	16+0,5	511,5	20° / 25°	1600	1500	135
HL 10007	22"	Gizli Kanat	23	16+0,5	556,5	20° / 25°	1700	1500	137
HL 10008	24"	Gizli Kanat	23	16+0,5	602,5	20° / 25°	1800	1500	139
HL 10009	28"	Gizli Kanat	23	16+0,5	707,5	10° / 15° / 20°	2000	1500	155
HL 10010	26" / 180"	Gizli Kanat	23	16+0,5	690	20°	2000	1500	155
						7° (*)	2500(*)	1700(*)	180(*)

*İlave limitleme makası ile kullanım.

★ Yandaki profil birim ağırlıkları, bilgisayarla hesaplanmış teorik ağırlıklardır.

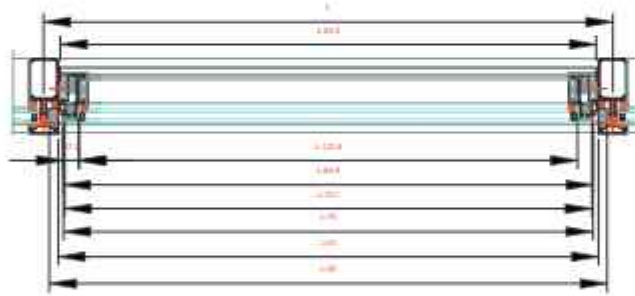
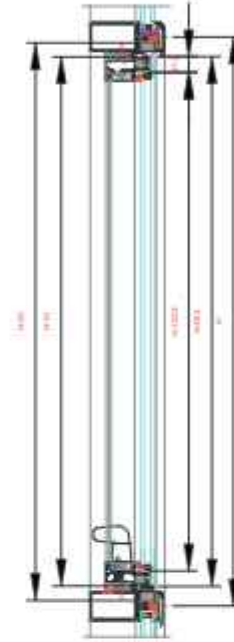
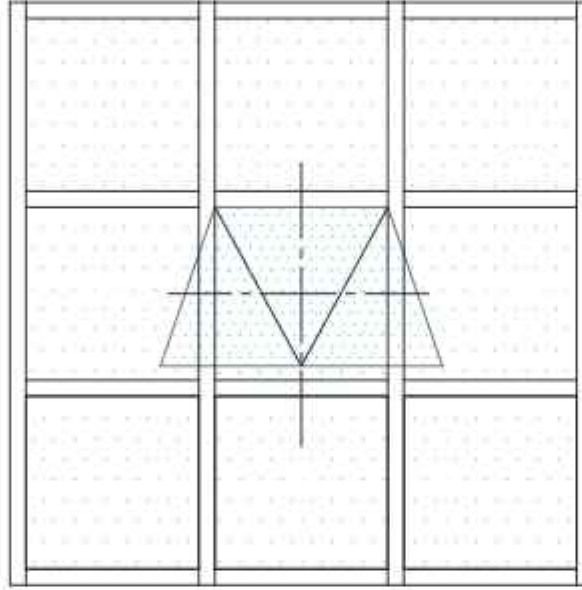

PROFİL	Adet	Resim Ölçüsü (mm.)
1725	2	R20
1725	2	L20
1735	2	L22
1735	2	L20
4140	2	H22,7
4140	2	L22,7
2020	2	L31
2019	2	L31

CAM (Ağırlık)	Adet	Cam Destek	İncelik Ölçüsü (mm.)
Dış Cam (Düsey)	1		
Dış Cam (Yatay)	1		
İç Cam (Düsey)	1		
İç Cam (Yatay)	1		

PROFİL VE BAĞLANTI ELEMANLARI	Birim	Miktar
K304 2547	Gizli Kasa Köşe Takozu	Adet 4
K246 2547	Gizli Kasa Köşe Takozu	Adet 4
K345 9327	Gizli Kanat Köşe Takozu	Adet 4
K139 9327	Gizli Kanat Köşe Takozu	Adet 4
K4141 0100	Cam Destek Takozu	Adet 2

AKSESUAR	Birim	Kolaylaştırıcı	Miktar
		2 Nokta	4 Nokta
--- Kırık Kıl	Adet	1	1
--- Makas (10°)	Takım	1	1
--- Ayarlı Pim	Adet	2	4
--- Üst Kilitleme Elemanı	Adet	2	2
--- Bağlantı Elemanı	Adet	2	2
--- Epoksi Karışık	Adet	2	4
--- Köşe Döme	Adet	-	2

★ Yandaki profil birim ağırlıkları, bilgisayarla hesaplanmış teorik ağırlıklardır.

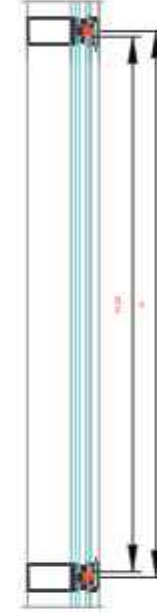
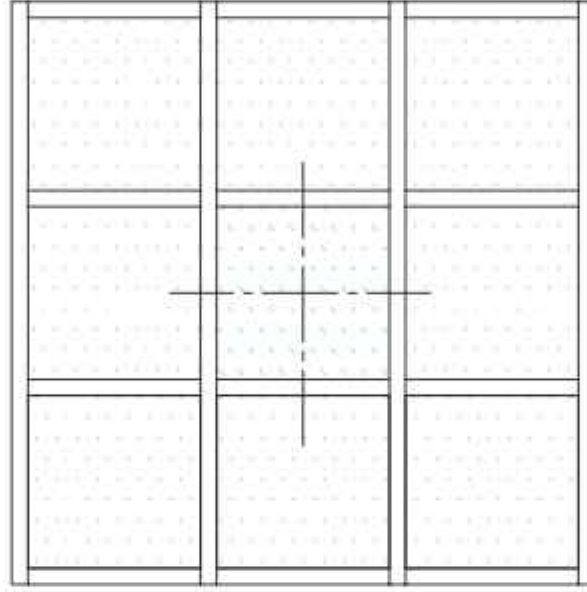

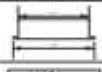
PROFİL	Adet	Keşim Ölçüsü (mm)
Tüm Yatay Profiller	2	
2020 Yatay Kapak Profili	2	L-51
2019 Kapak Altı Profili	2	L-51

CAM (Sayı)	Adet	Cam Detayı	Keşim Ölçüsü (mm)
Dış Cam	1		
İç Cam			

FİTİL VE BAĞLANTI ELEMANLARI	Birim	Miktar
... Yatay Bağlantı Profili	Adet	4
K4148 0100 Cam Destek Takozu (2020 Yatay Kapak Altı ve 2019 Kapak Altı)	Adet	2
HL01 Yatay Griyaj Fıtlı	mm	2*(L - 24)
... Kapak Altı Fıtlı	mm	4*(L - 51)

★ Yandaki profil birim ağırlıkları, bilgisayarla hesaplanmış teorik ağırlıklardır.

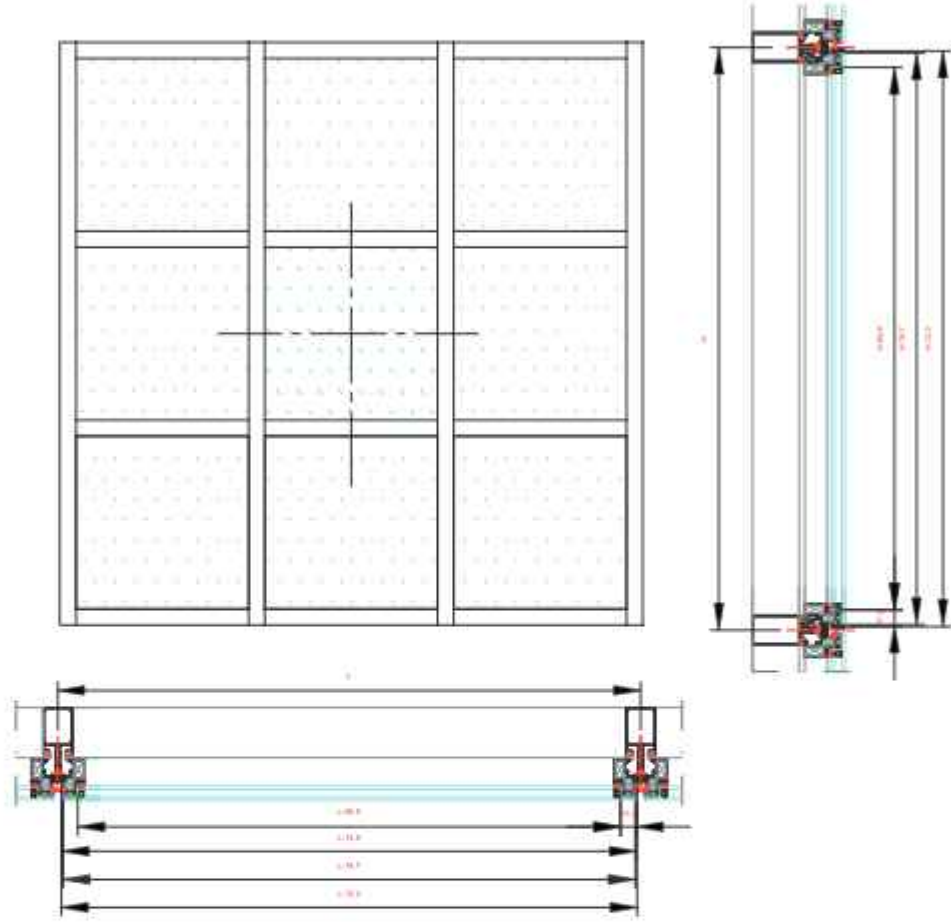

PROFİL	Azad	Kesit Ölçüsü (mm)	
2954	Gizli Kanat Profili (Döşey)	2	11-32.3
2954	Gizli Kanat Profili (Yatay)	2	11-32.3
4140	Bordür T1 Profili (Döşey)	2	11-10.7
4140	Bordür T1 Profili (Yatay)	2	11-10.7

CAM / Açık	Azad	Giriş Değeri	Kesit Ölçüsü (mm)
Dış Cam (Döşey)	1	11-32.3	11-32.3
Dış Cam (Yatay)			
İç Cam (Döşey)	1	11-10.7	11-10.7
İç Cam (Yatay)			

FİTİL VE BAĞLANTI ELEMANLARI		Birim	Miktar
3429	Kanat Köşe Takozu	Adet	4
3429	Gizli Kanat Köşe Takozu	Adet	4
K4141 0100	Cam Destek Takozu (Dış kesime göre paslanmaz alüminyum)	Adet	2

AKSESUAR		Birim	Kilitleme	
			2 Nokta	4 Nokta
...	Kıvrık Kol	Adet	1	1
...	Makas (10 ")	Takım	1	1
...	Ayarlı Pim	Adet	2	4
...	Üst Kilitleme Elemanı	Adet	2	2
...	Bağlantı Elemanı	Adet	2	2
...	Sabit Karşılık	Adet	2	4
...	Köşe Dönme	Adet	-	2

DETAY- 1
ÖLÇEK:1/1

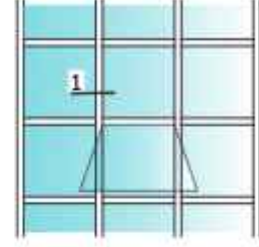

★ Yandaki profil birim ağırlıkları, bilgisayarla hesaplanmış teorik ağırlıklardır.

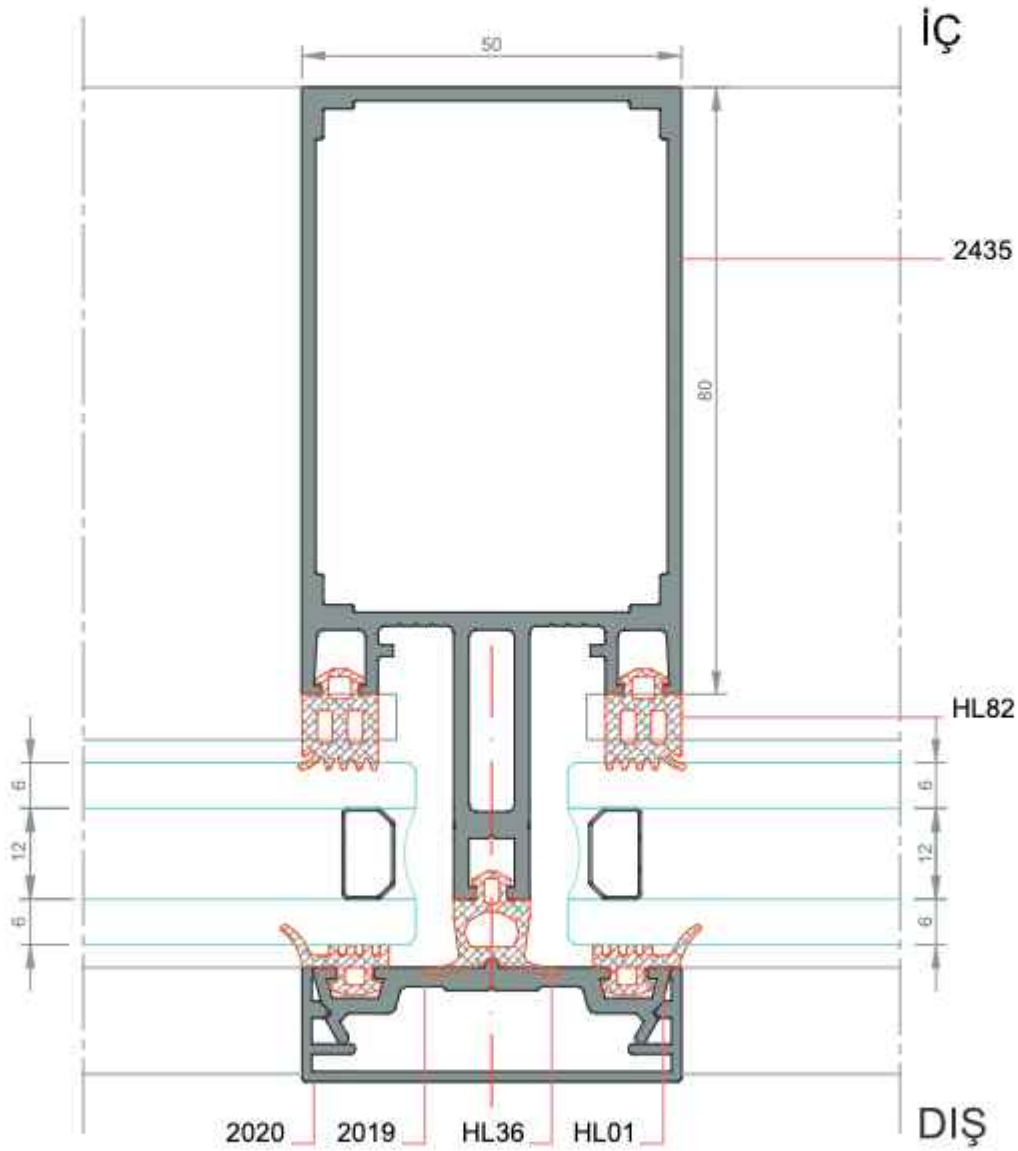

DETAY- 2
ÖLÇEK:1/1

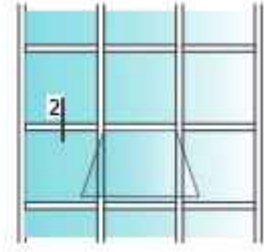

★ Yandaki profil birim ağırlıkları, bilgisayarla hesaplanmış teorik ağırlıklardır.

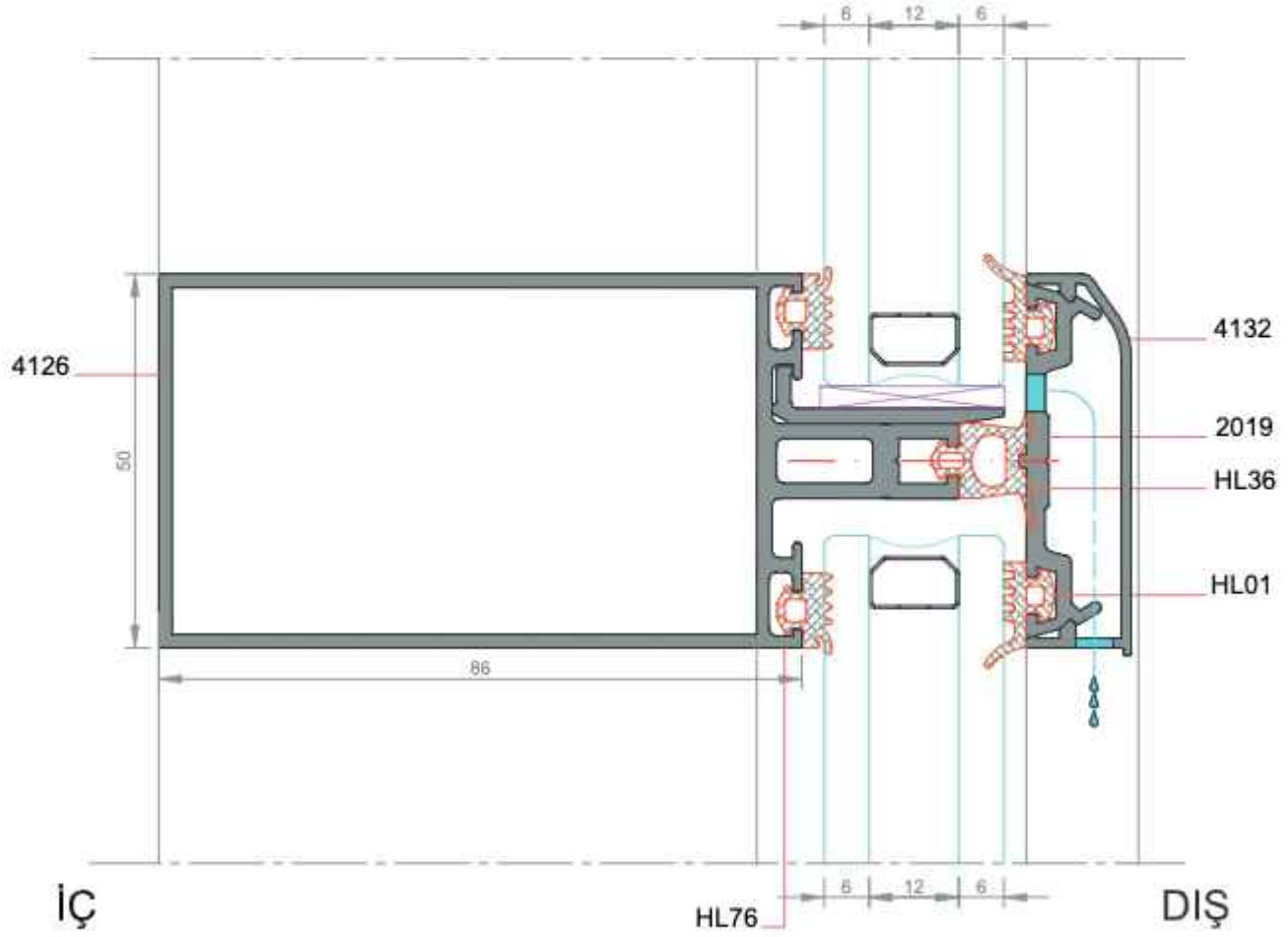

DETAY- 3

ÖLÇEK:1/1

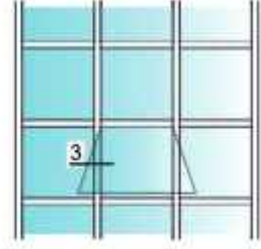

★ Yandaki profil birim ağırlıkları, bilgisayarla hesaplanmış teorik ağırlıklardır.

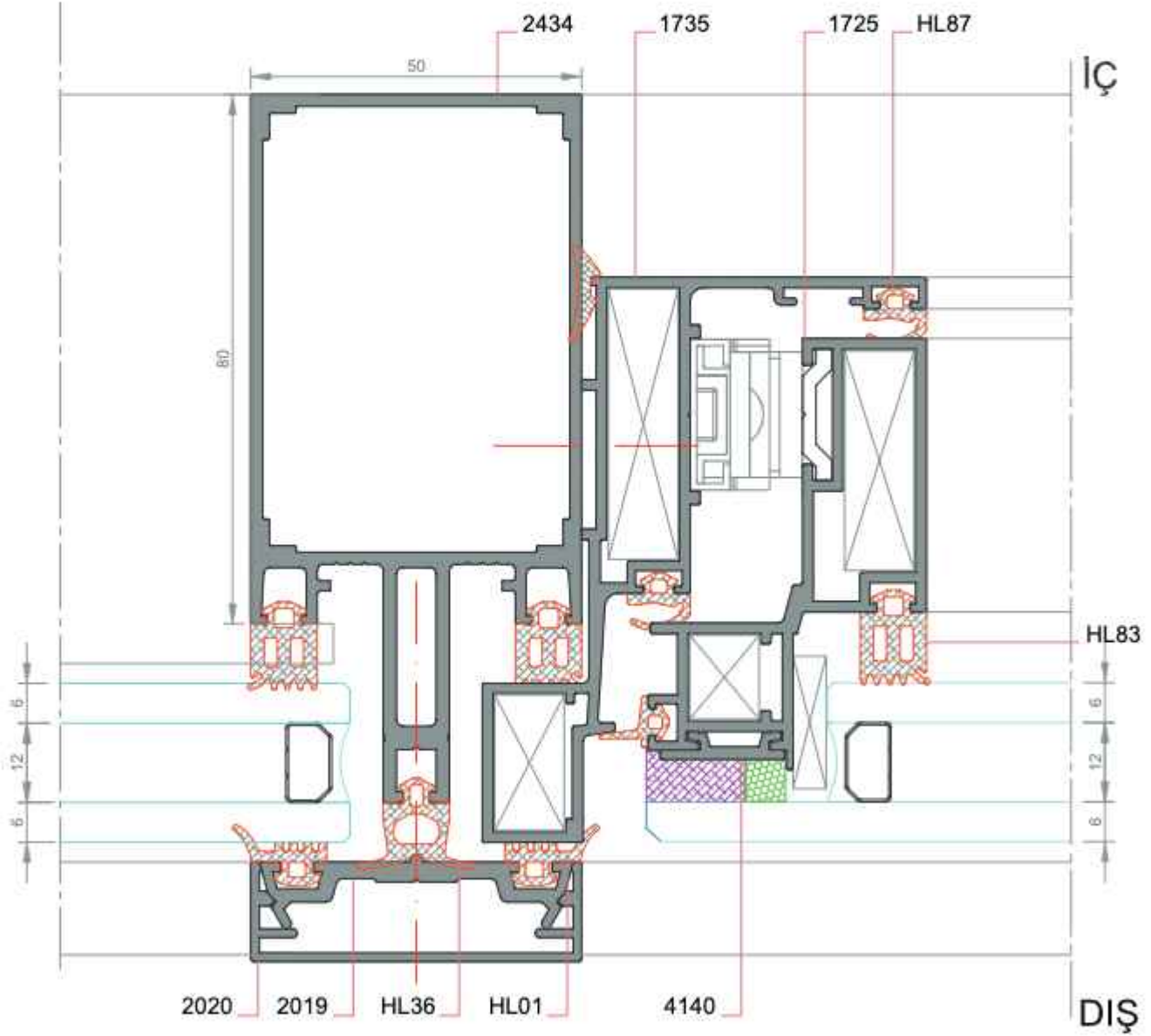

NOT: Mesafe belirleyici bant ve strüktürel silikon, cam yapıştırma firmasına aittir.
Özel ortamda, test edilerek uygulanmalıdır, aksi takdirde emniyeti kabul edilemez.

DETAY- 4
ÖLÇEK:1/1



★ Yandaki profil birim ağırlıkları, bilgisayarla hesaplanmış teorik ağırlıklardır.

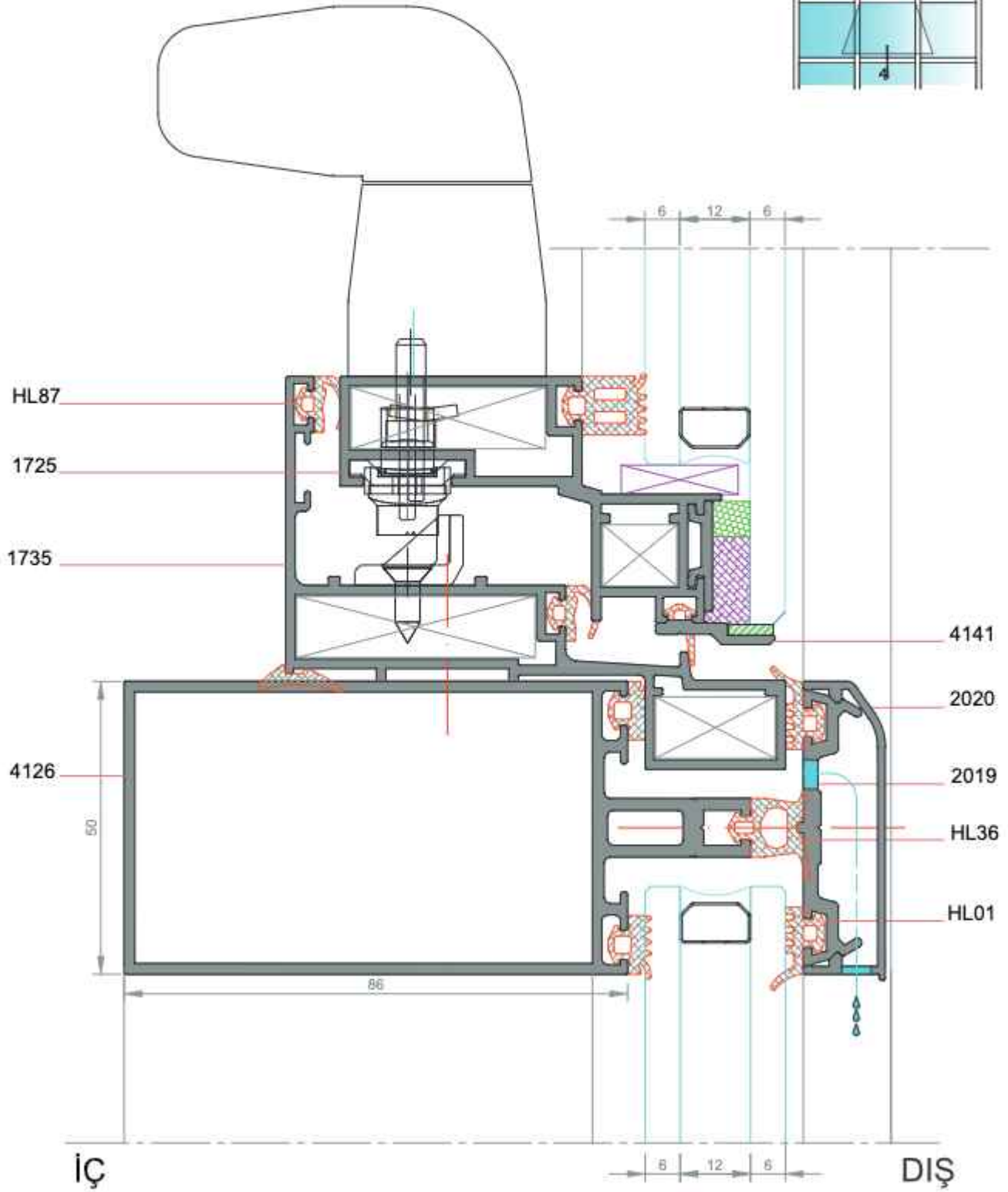

DETAY- 5
ÖLÇEK:1/1

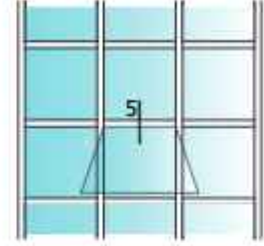

★ Yandaki profil birim ağırlıkları, bilgisayarla hesaplanmış teorik ağırlıklardır.

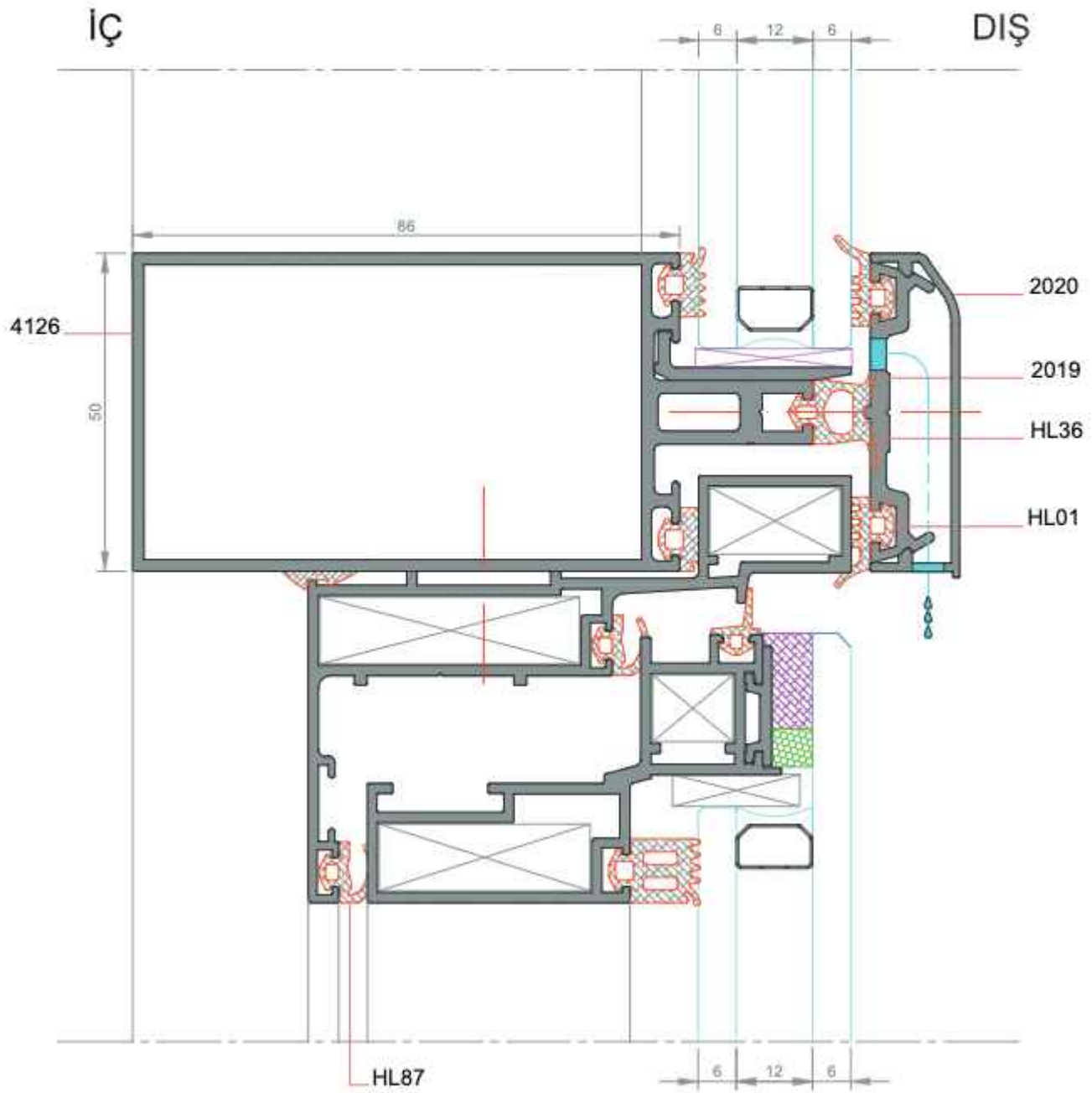

DETAY- 1
ÖLÇEK:1/1



★ Yandaki profil birim ağırlıkları, bilgisayarla hesaplanmış teorik ağırlıklardır.

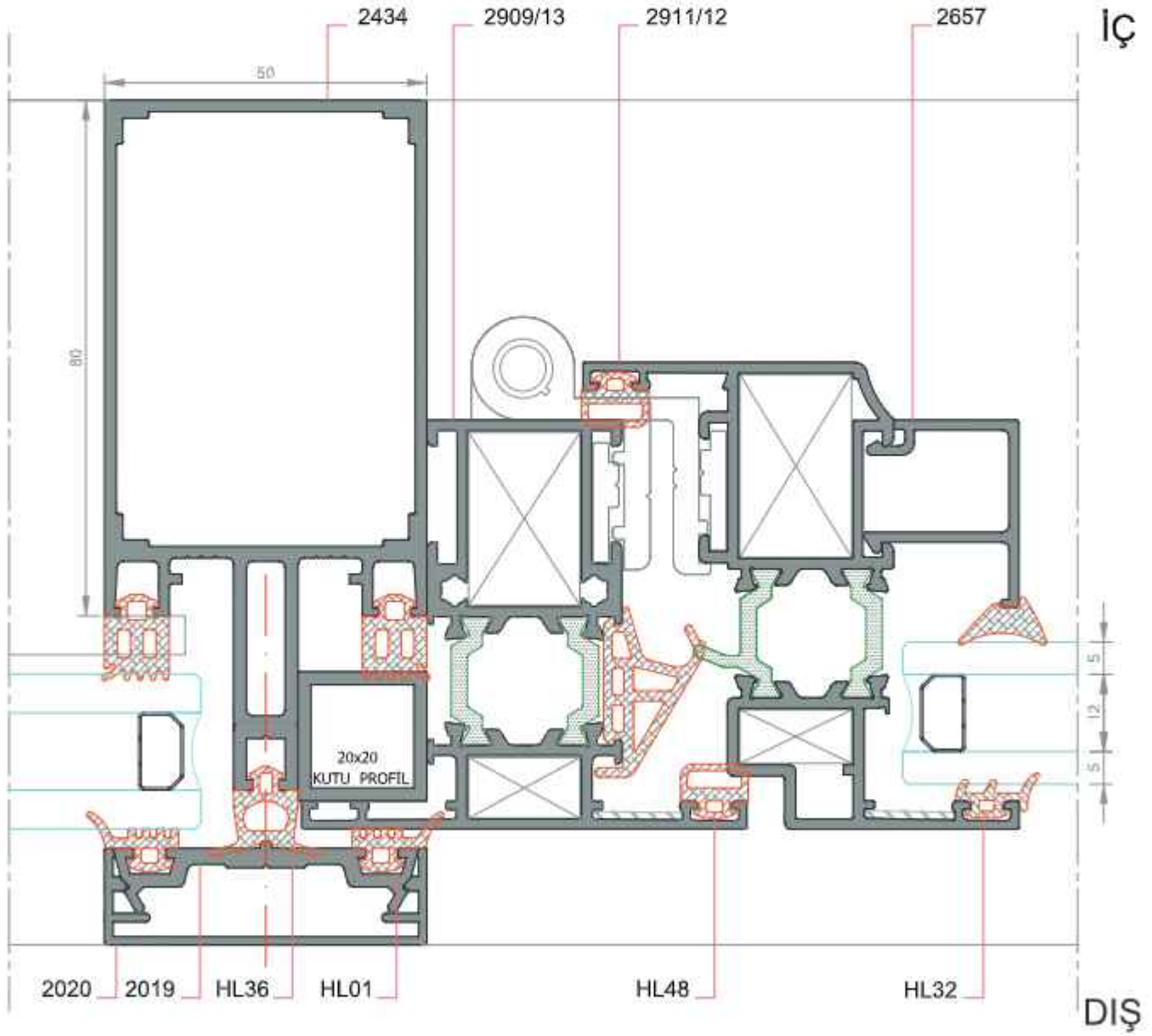

DETAY- 2a
ÖLÇEK:1/1

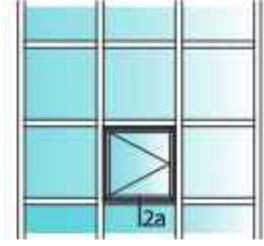

★ Yandaki profil birim ağırlıkları, bilgisayarla hesaplanmış teorik ağırlıklardır.

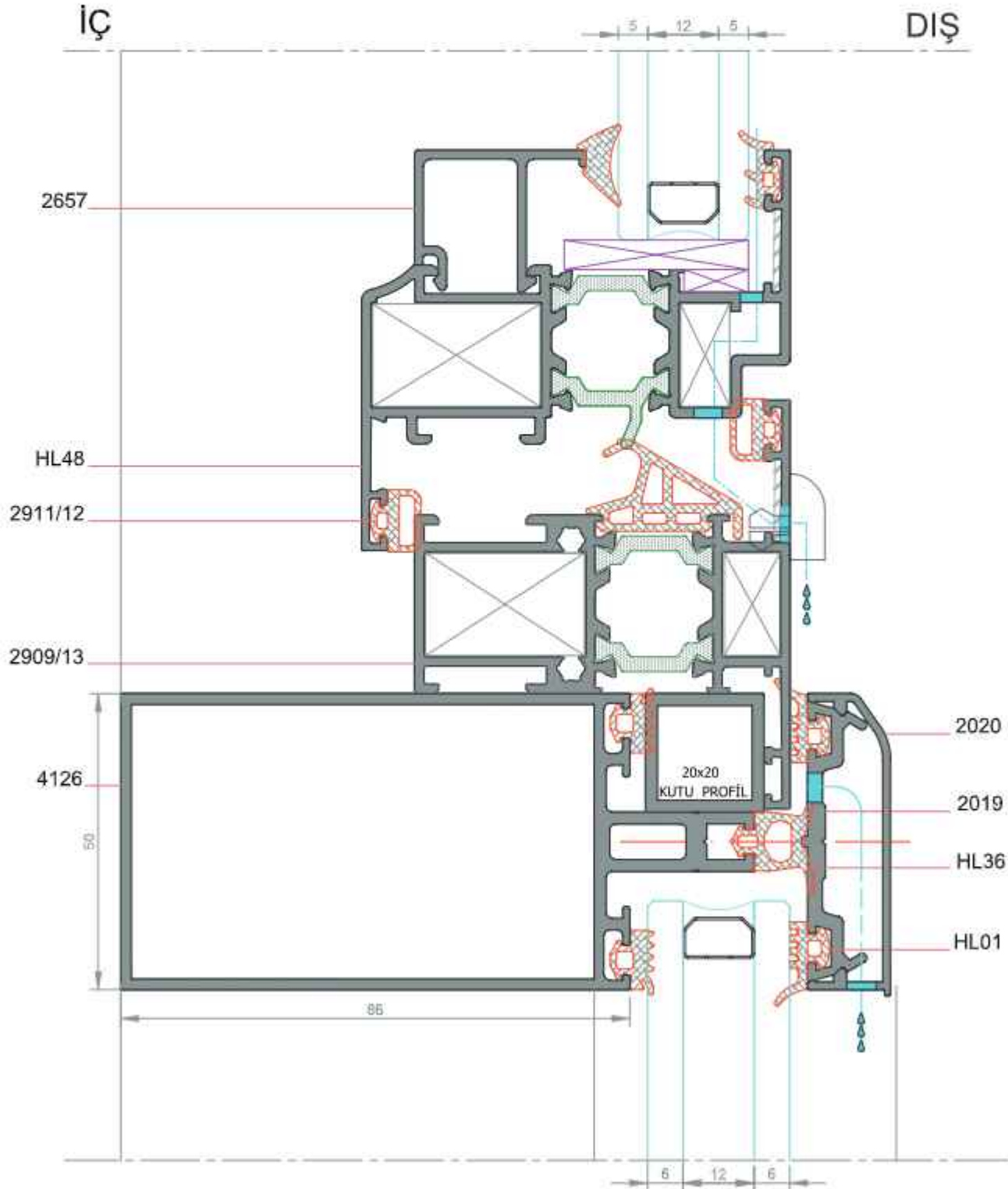

DETAY- 1b
ÖLÇEK:1/1

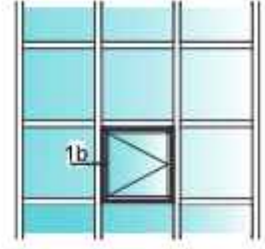

★ Yandaki profil birim ağırlıkları, bilgisayarla hesaplanmış teorik ağırlıklardır.

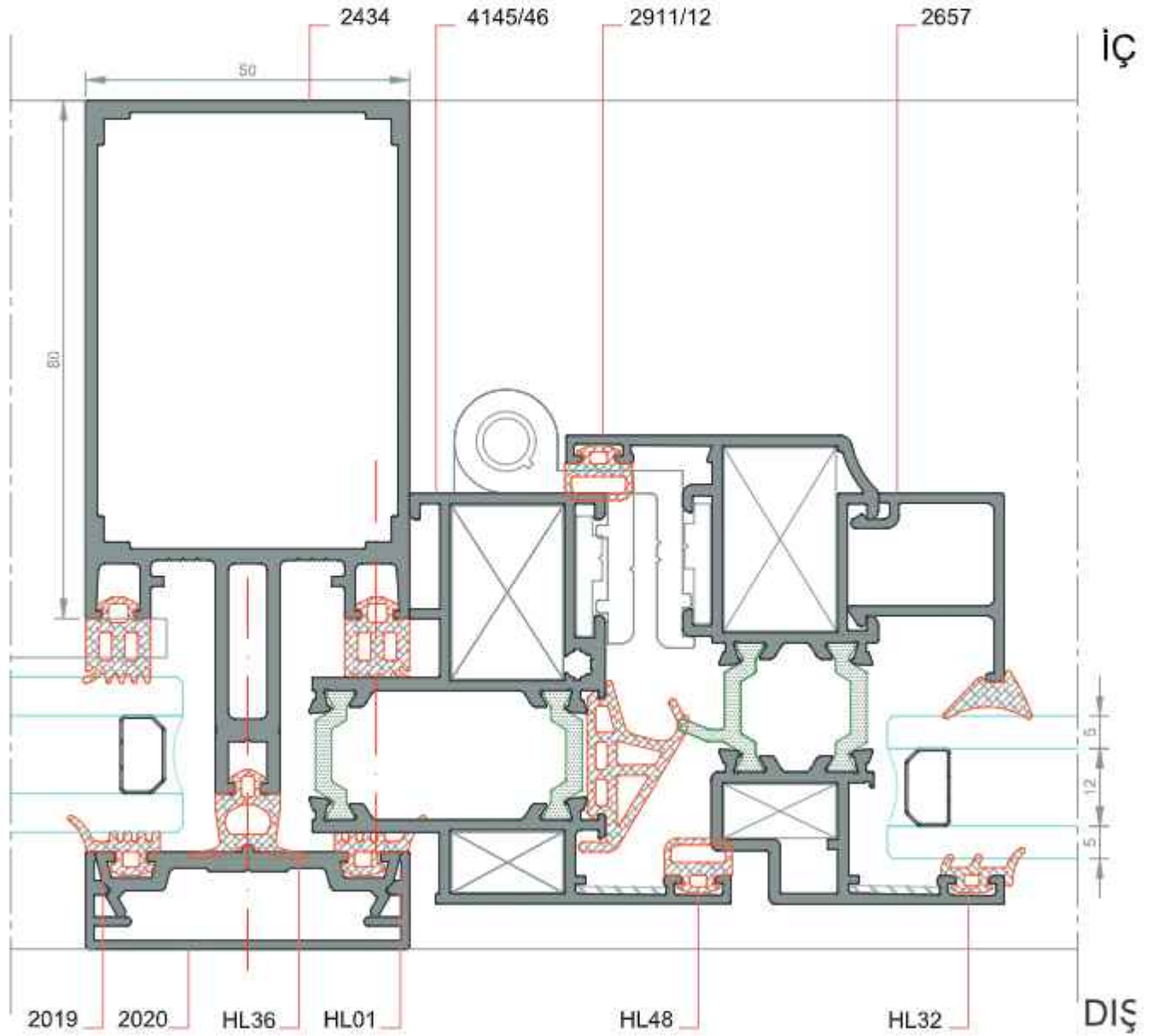

DETAY- 2b

ÖLÇEK:1/1

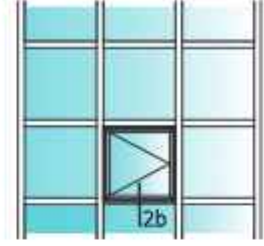

★ Yandaki profil birim ağırlıkları, bilgisayarda hesaplanmış teorik ağırlıklardır.

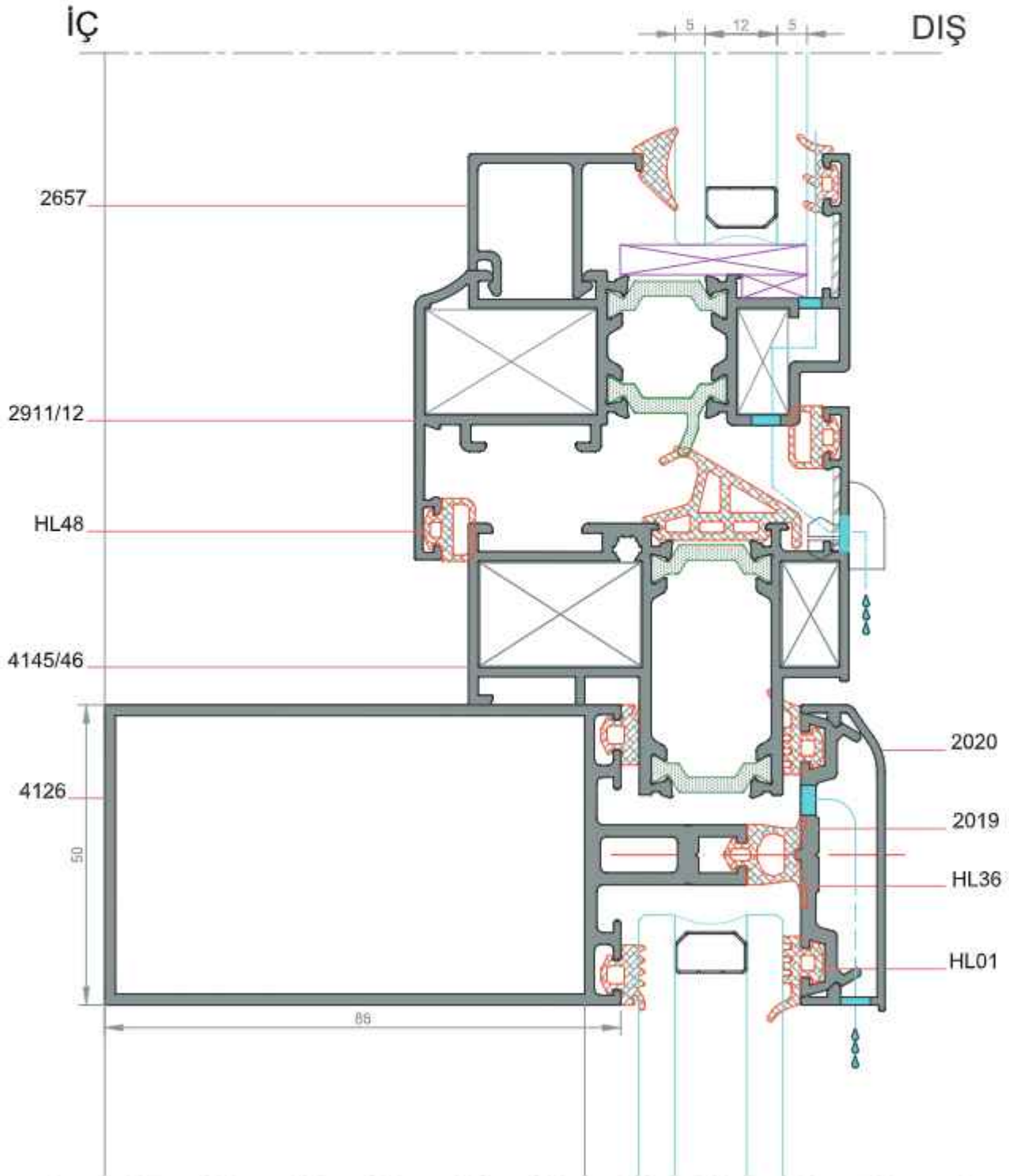

DETAY- 1
ÖLÇEK:1/1



★ Yandaki profil birim ağırlıkları, bilgisayarla hesaplanmış teorik ağırlıklardır.

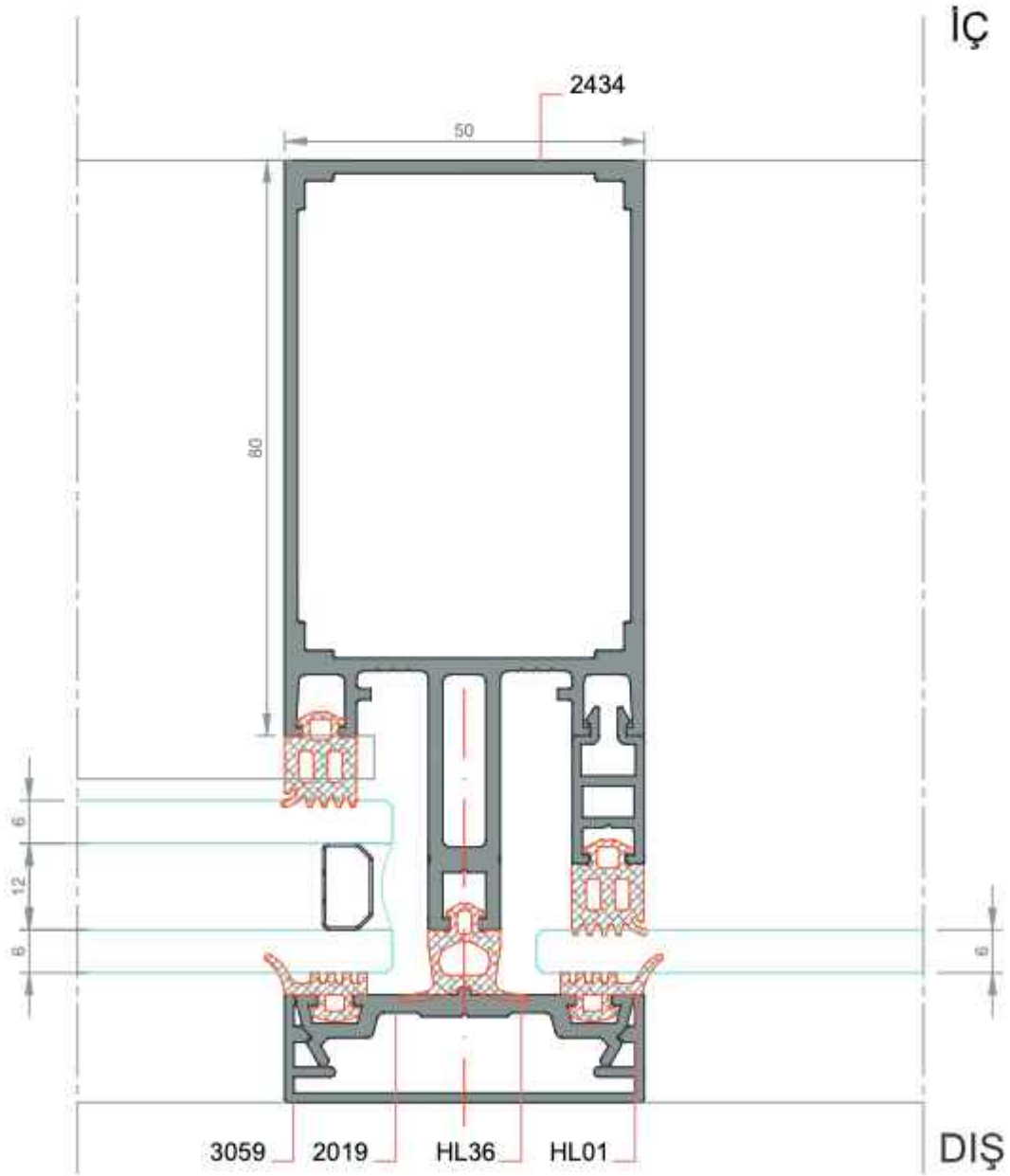

DETAY- 2

ÖLÇEK:1/1

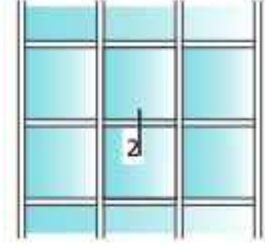

★ Yandaki profil birim ağırlıkları, bilgisayarla hesaplanmış teorik ağırlıklardır.

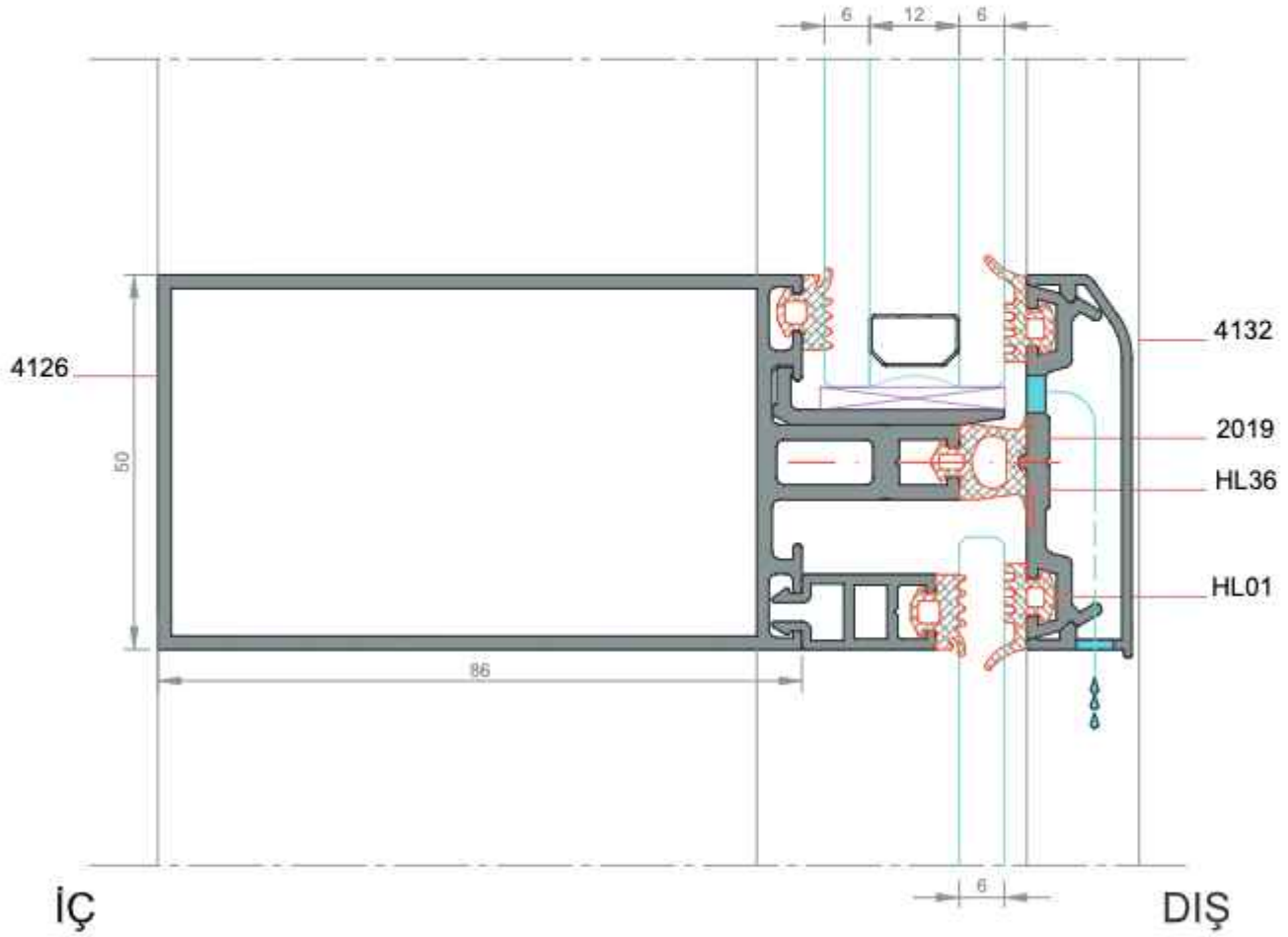

DETAY- 1
ÖLÇEK:1/1

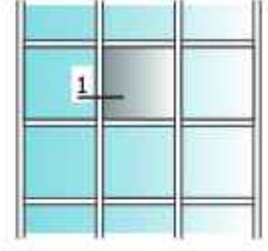

★ Yandaki profil birim ağırlıkları, bilgisayarla hesaplanmış teorik ağırlıklardır.

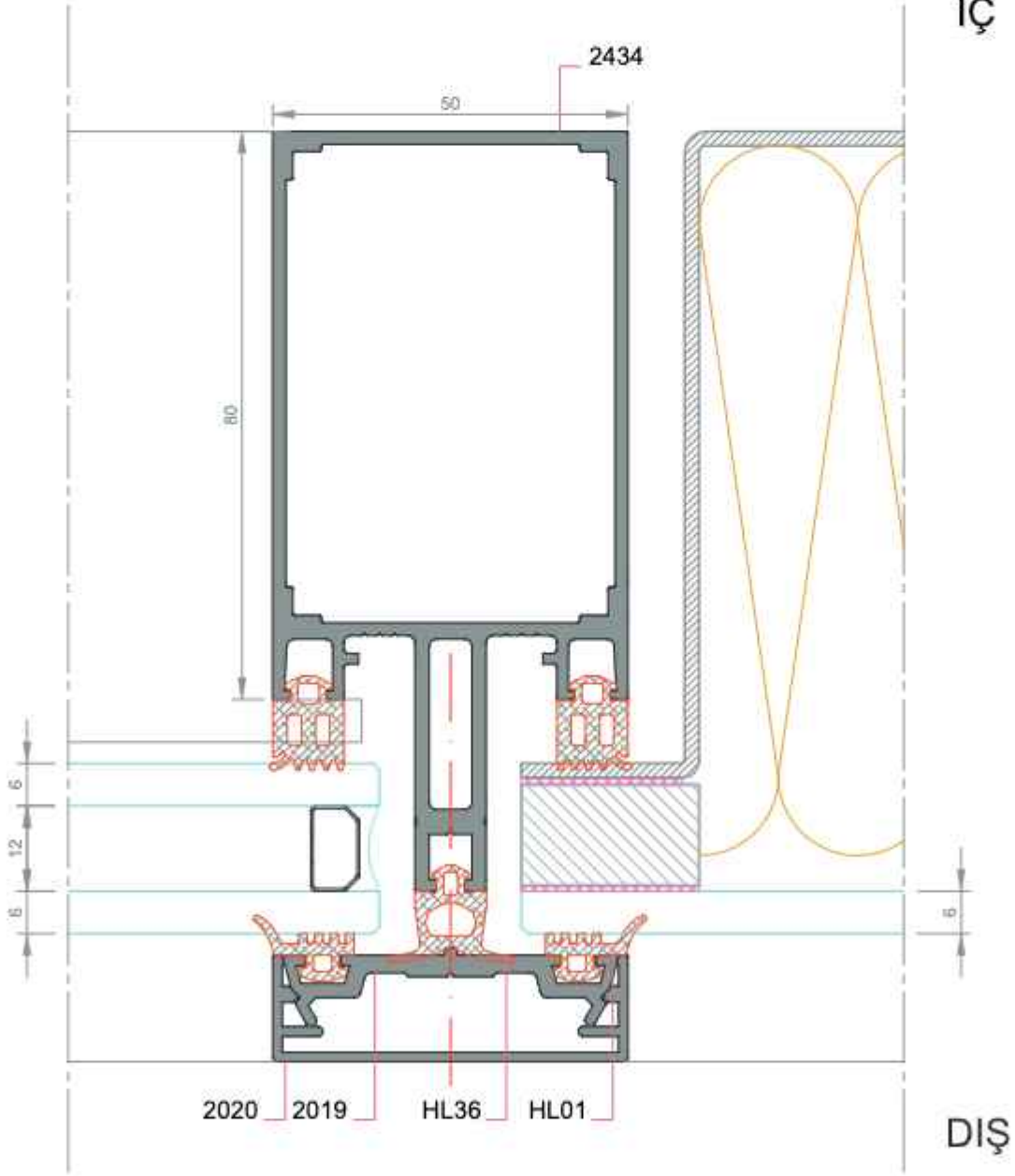

DETAY- 2
ÖLÇEK:1/1

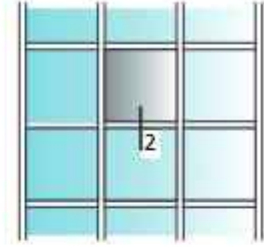

★ Yandaki profil birim ağırlıkları, bilgisayarla hesaplanmış teorik ağırlıklardır.

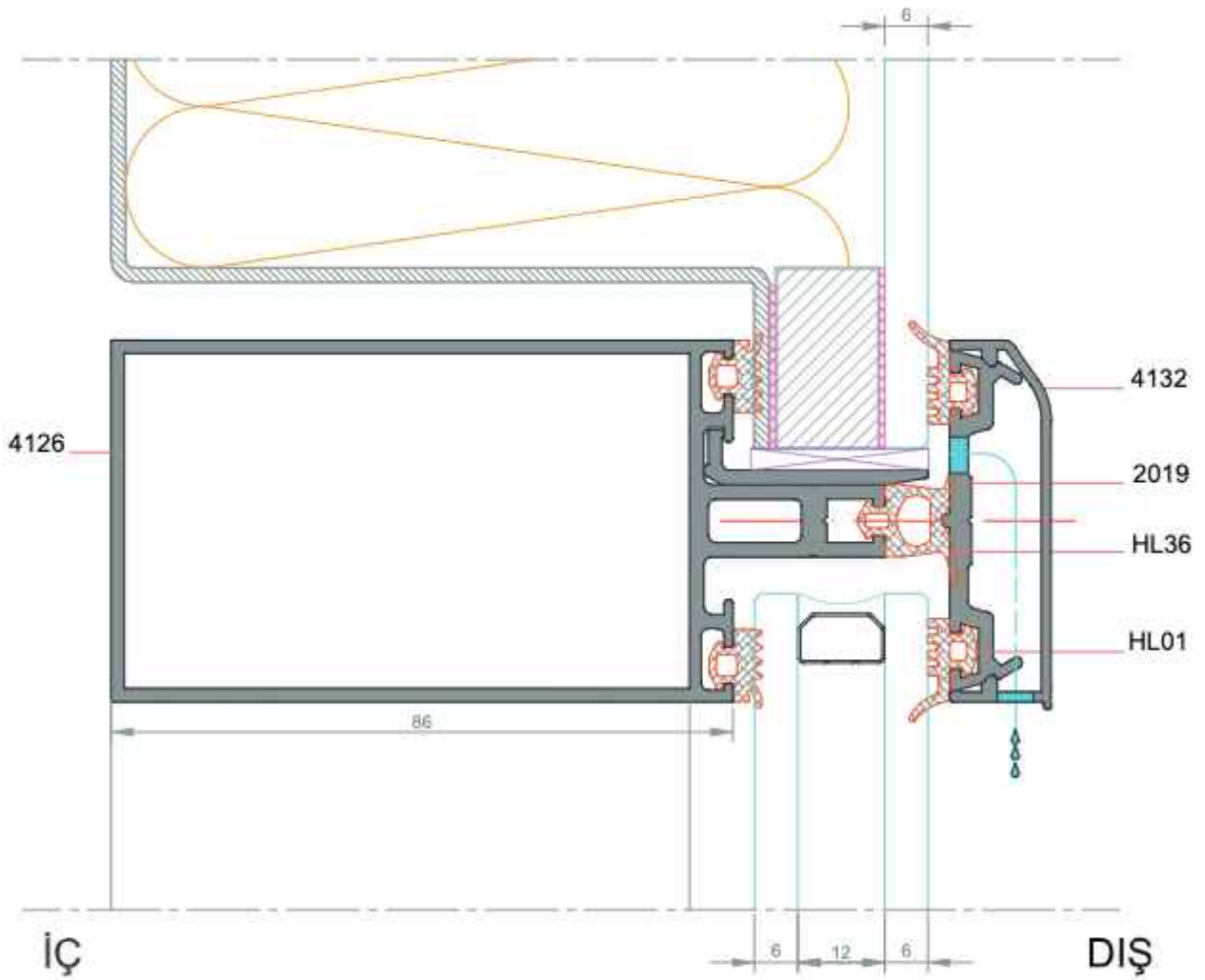

DETAY- 1
ÖLÇEK:1/1

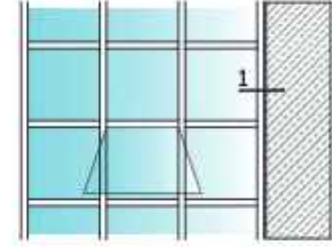

★ Yandaki profil birim ağırlıkları, bilgisayarla hesaplanmış teorik ağırlıklardır.

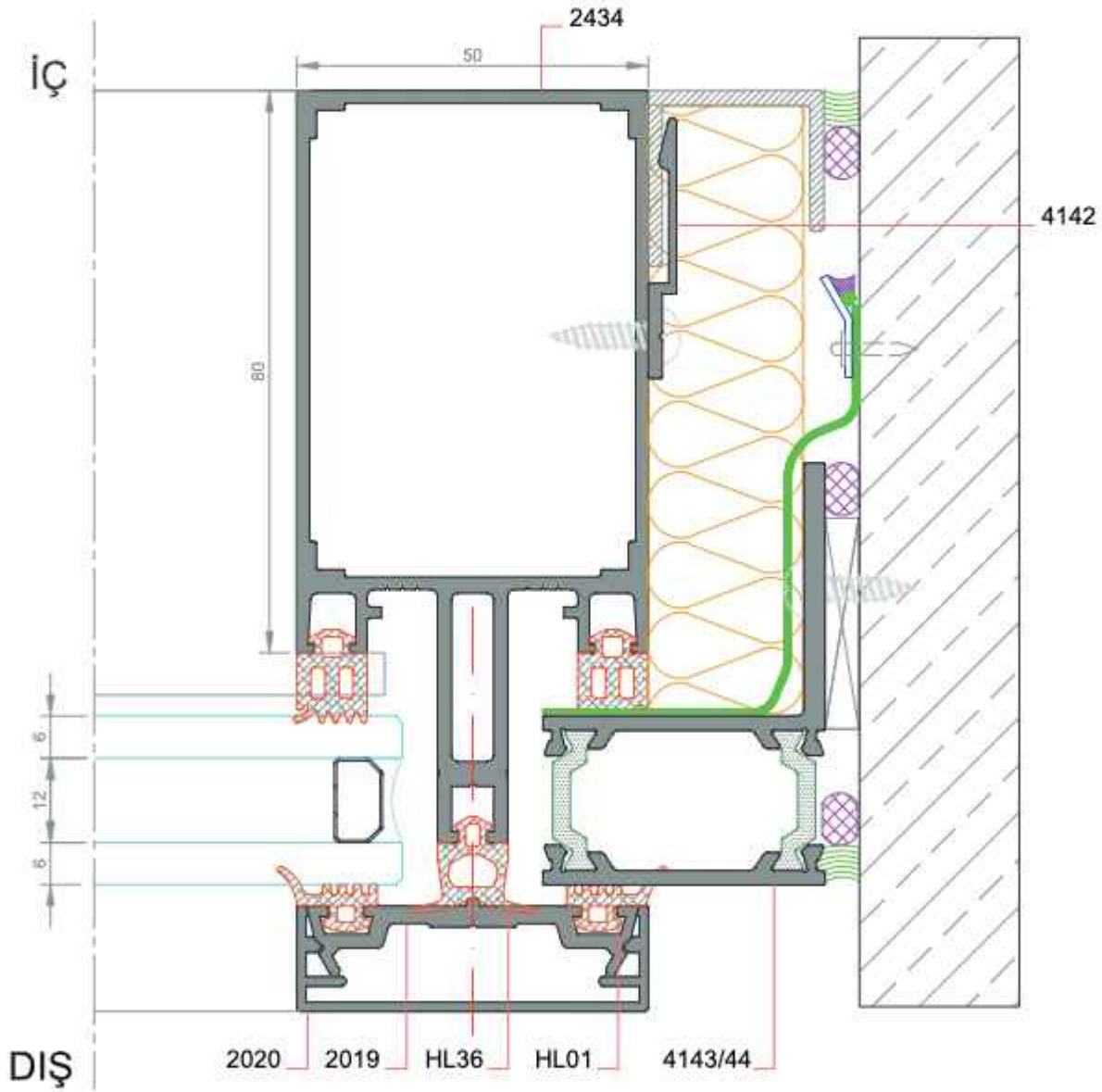

DETAY- 1
ÖLÇEK:1/1



★ Yandaki profil birim ağırlıkları, bilgisayarla hesaplanmış teorik ağırlıklardır.

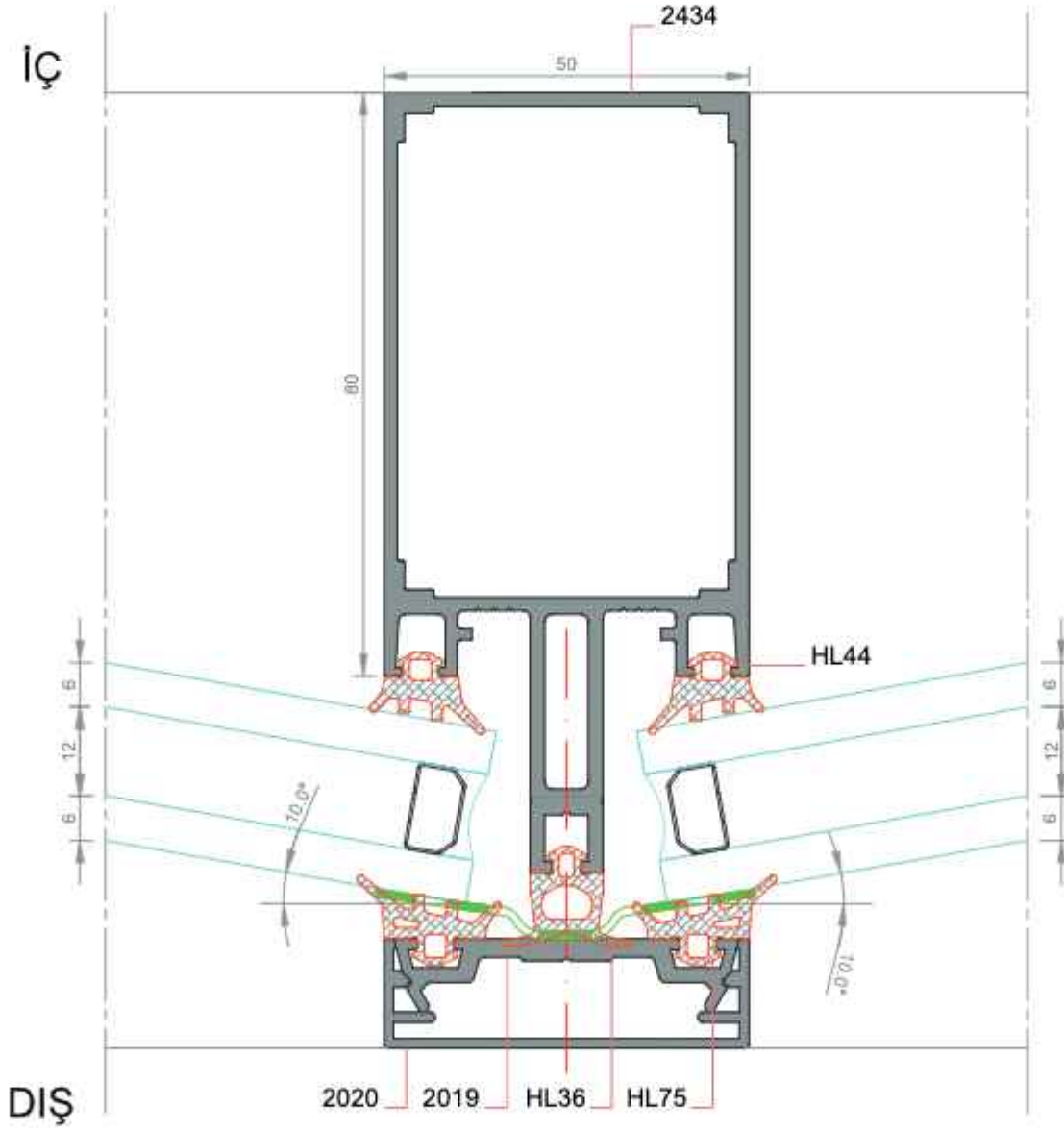

DETAY- 2
ÖLÇEK:1/1



★ Yandaki profil birim ağırlıkları, bilgisayarla hesaplanmış teorik ağırlıklardır.

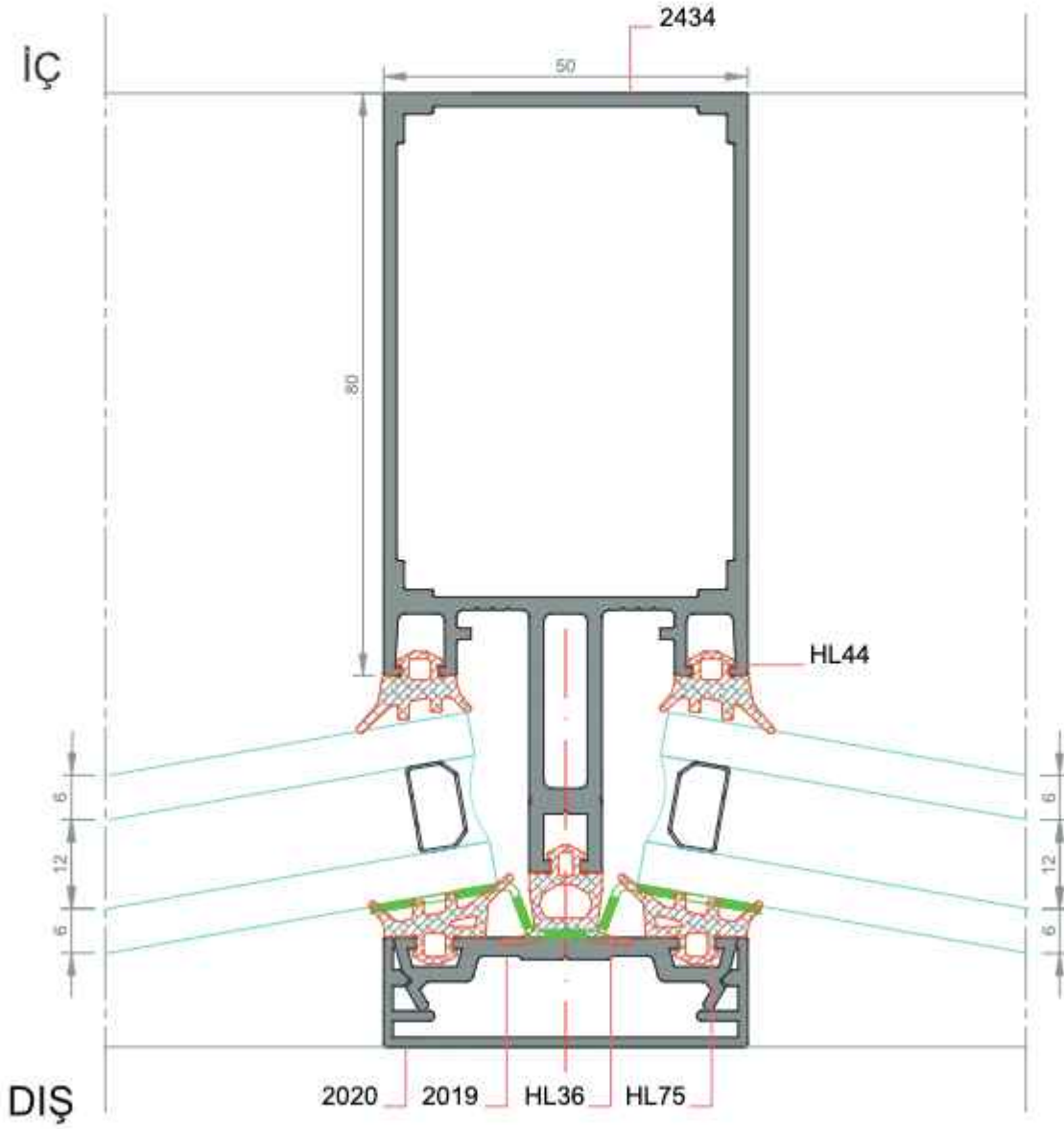

DETAY- 1
ÖLÇEK:1/1



90° DIŞ KÖŞE

★ Yandaki profil birim ağırlıkları, bilgisayarda hesaplanmış teorik ağırlıklardır.

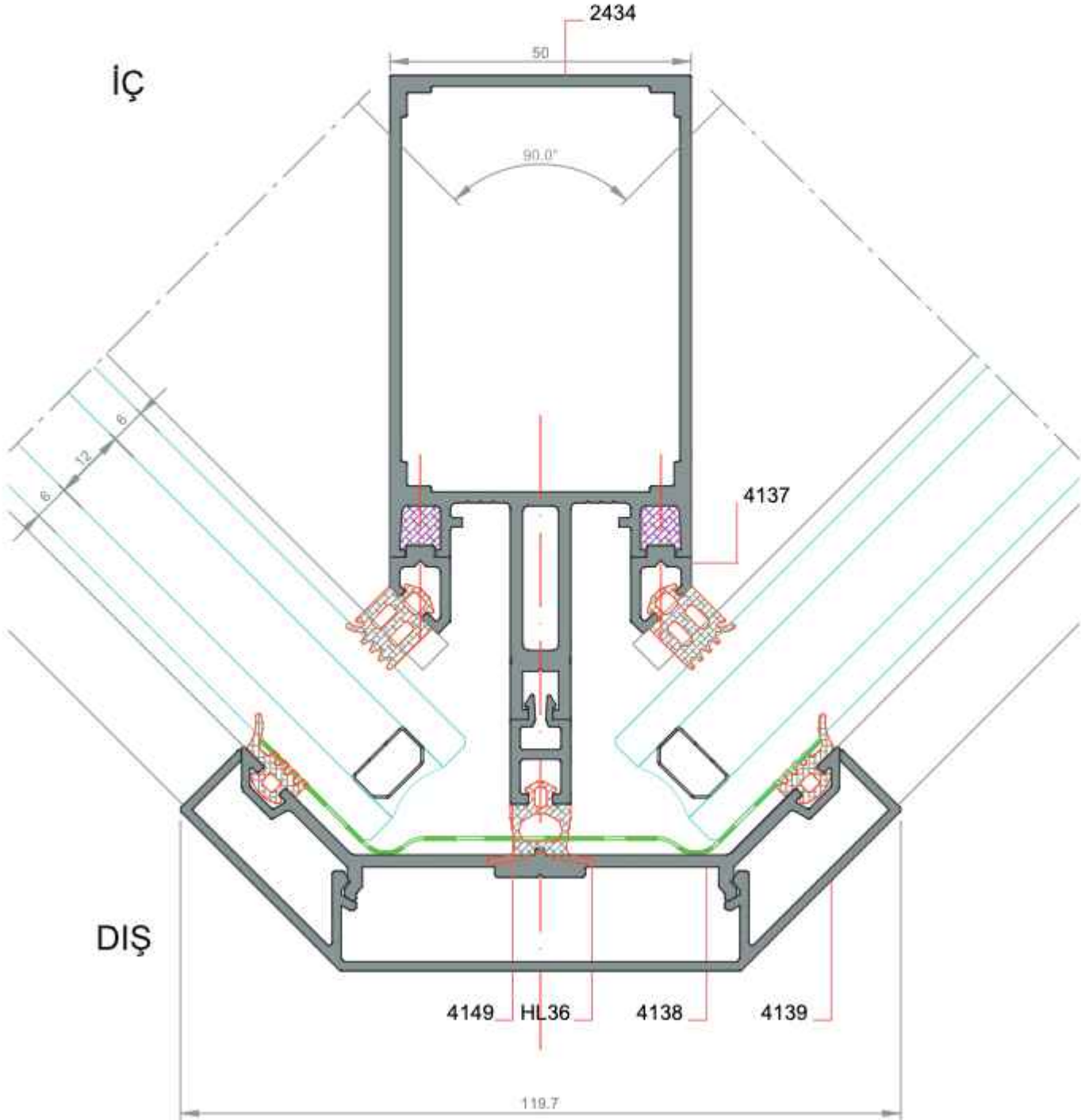

DETAY- 1
ÖLÇEK:1/1



İÇ

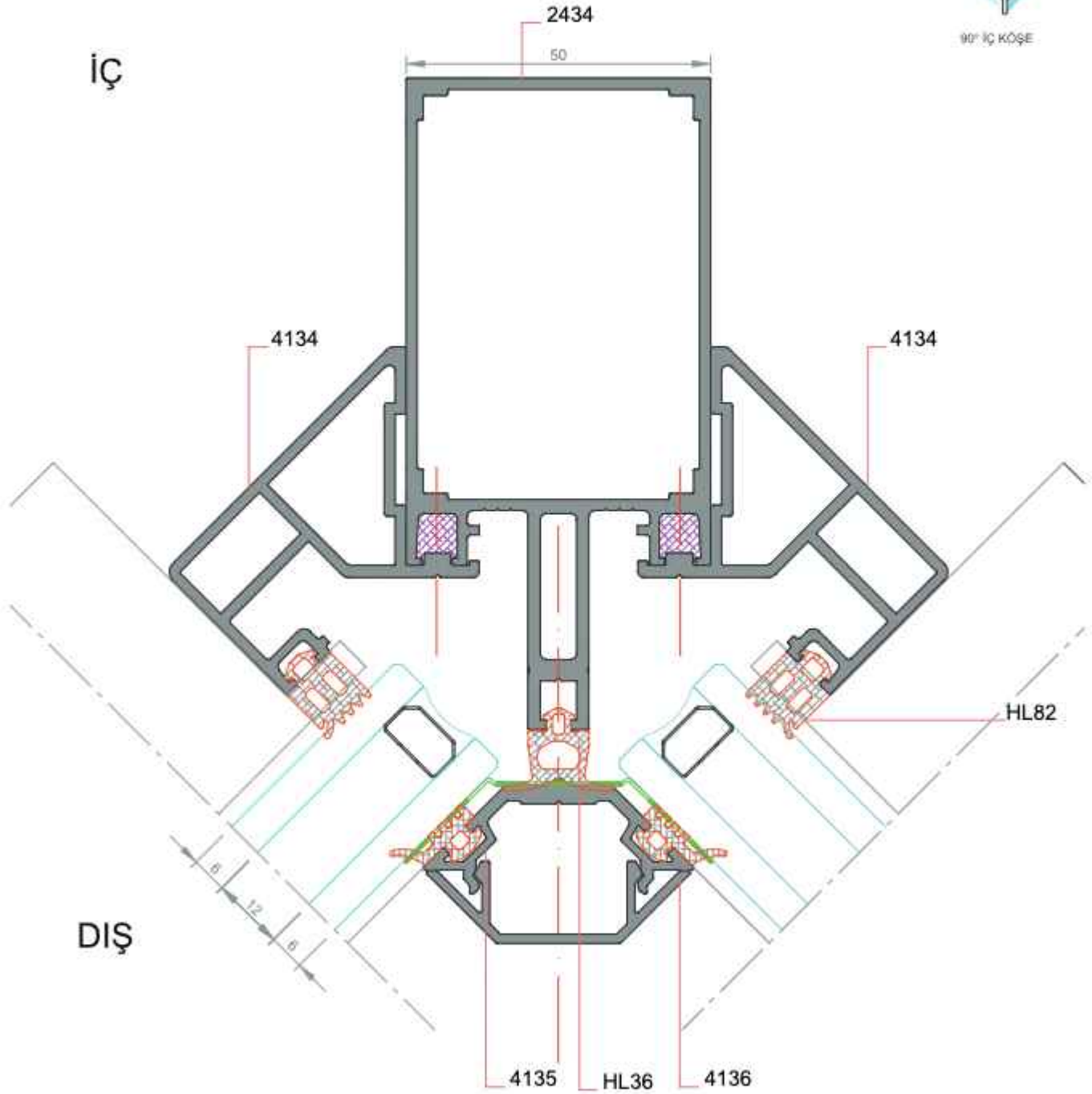

★ Yandaki profil birim ağırlıkları, bilgisayarla hesaplanmış teorik ağırlıklardır.

DIŞ

DETAY- 1
ÖLÇEK:1/1



★ Yandaki profil birim ağırlıkları, bilgisayarla hesaplanmış teorik ağırlıklardır.

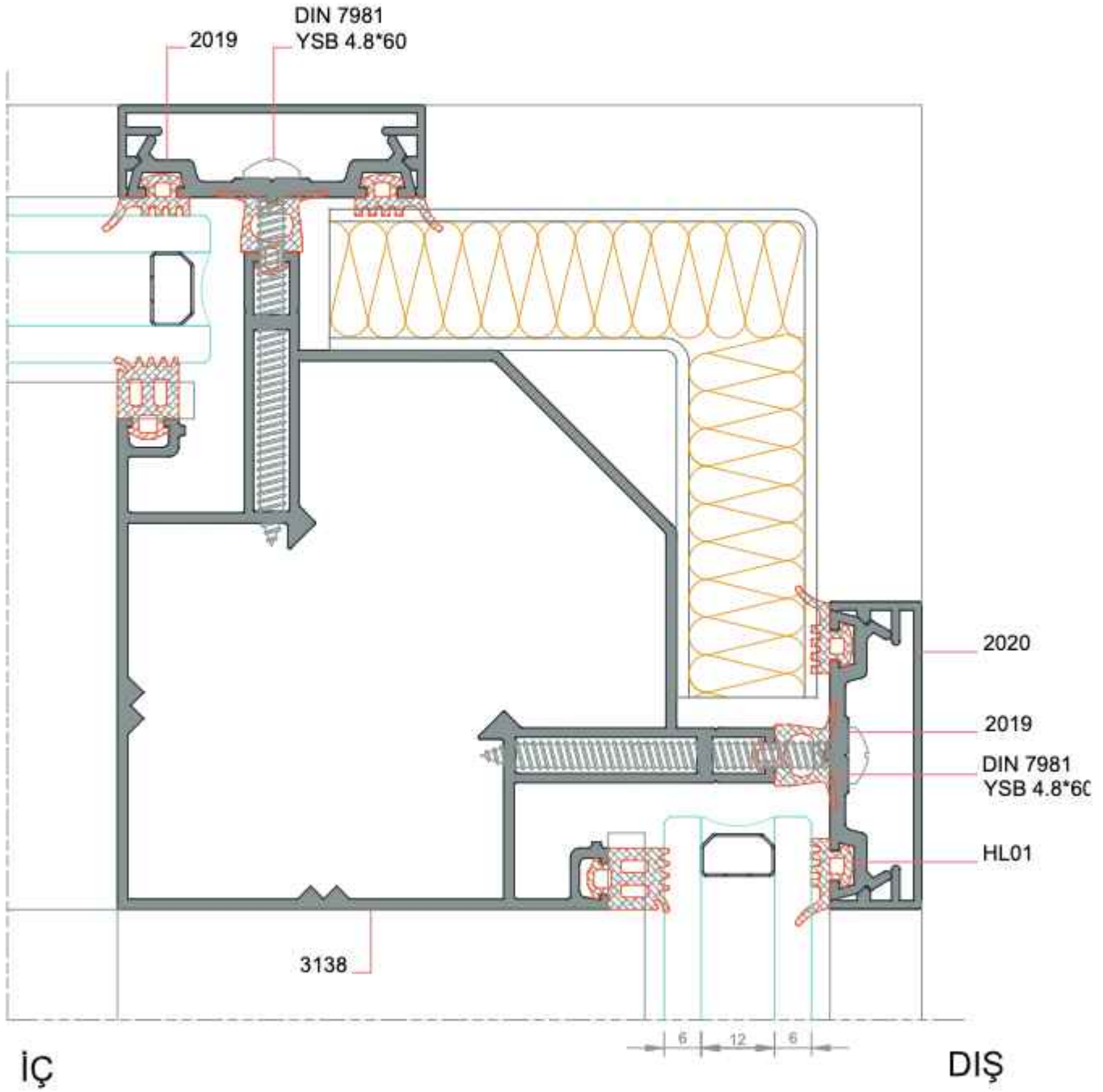

DETAY- 1
ÖLÇEKSİZ



90° İÇ KÖŞE

★ Yandaki profil birim ağırlıkları, bilgisayarla hesaplanmış teorik ağırlıklardır.

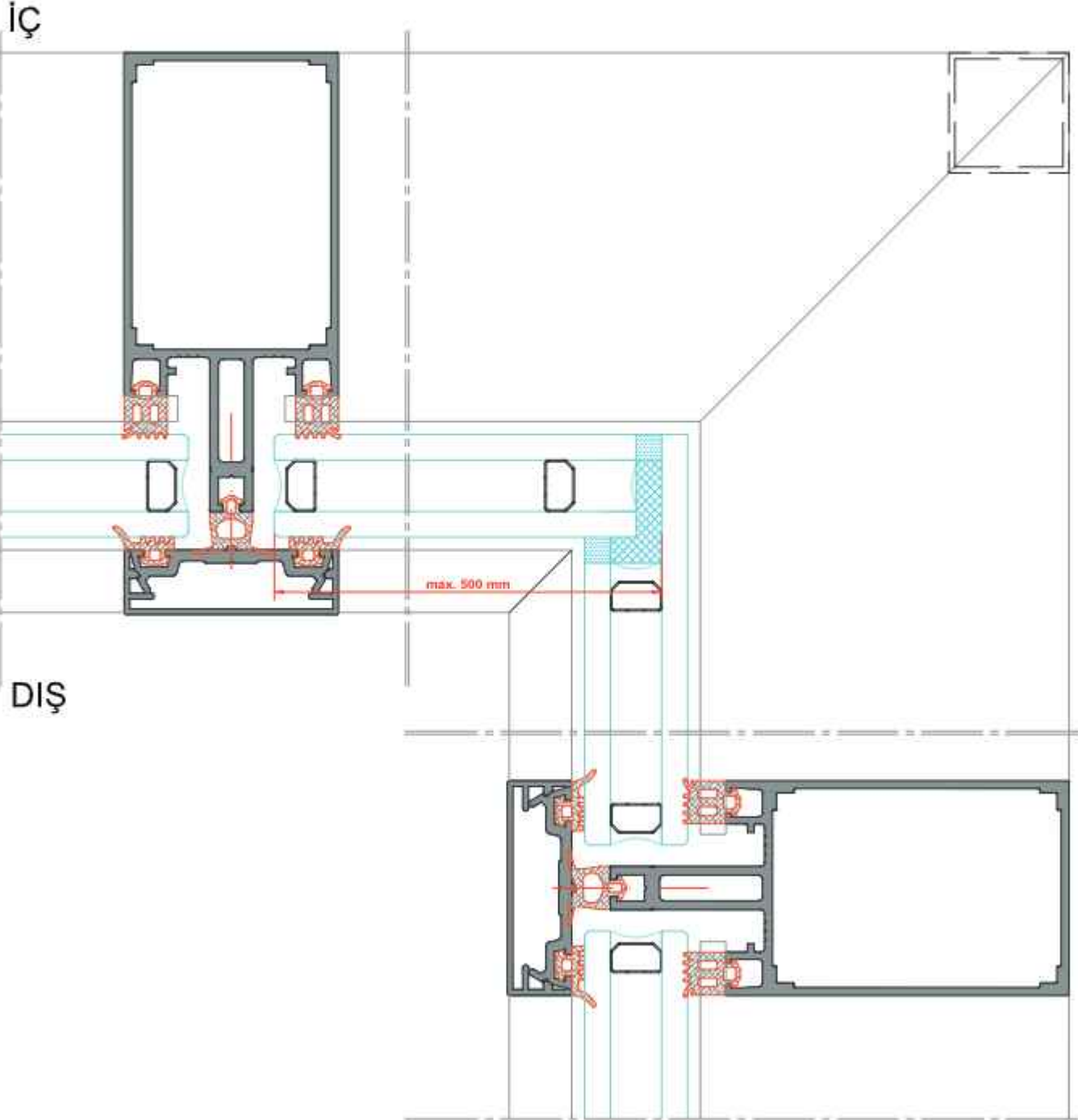

DETAY- 1
ÖLÇEKSİZ



90° DIŞ KÖŞE

★ Yandaki profil birim ağırlıkları, bilgisayarla hesaplanmış teorik ağırlıklardır.

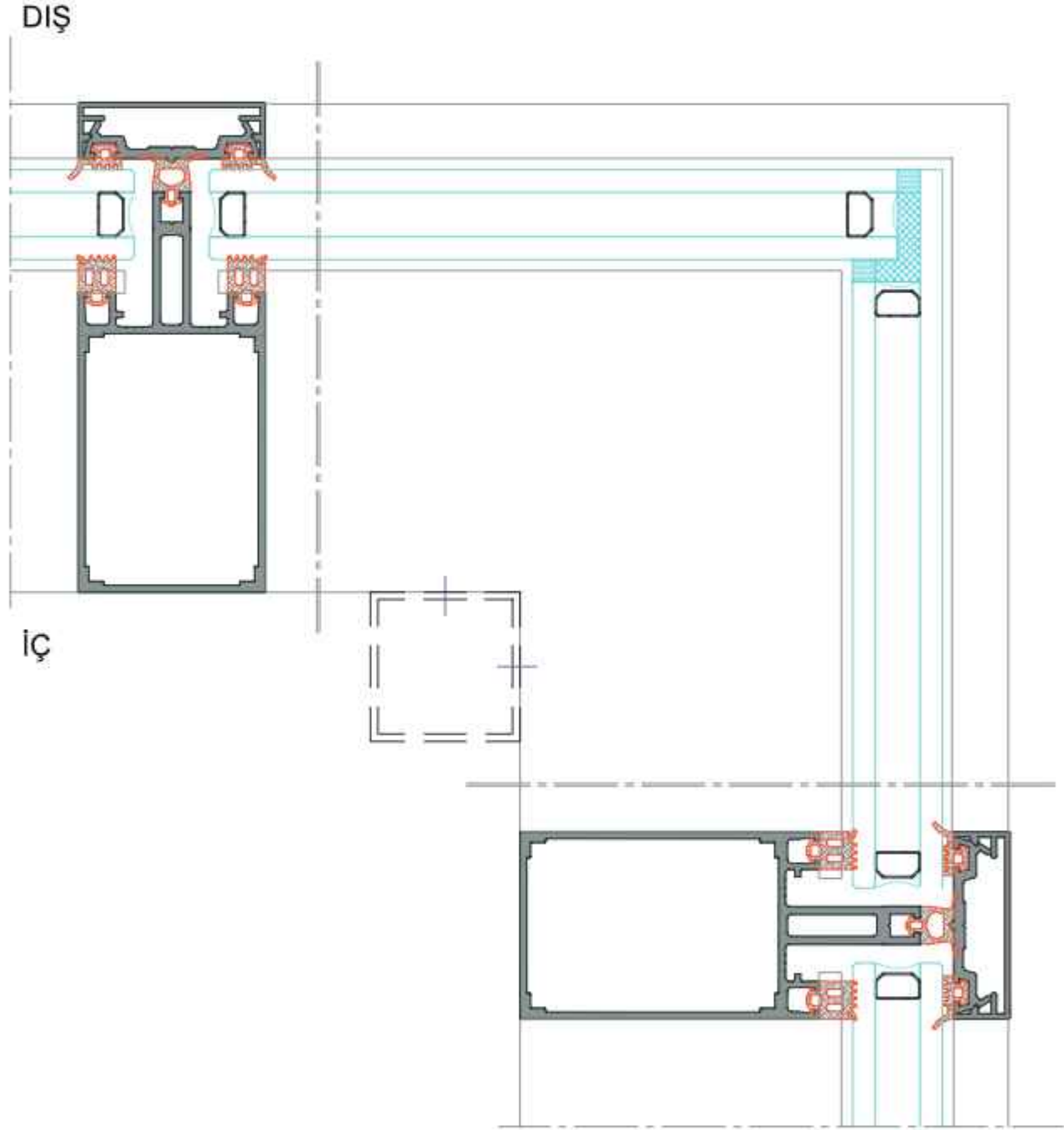

DETAY- 1
ÖLÇEKSİZ



★ Yandaki profil birim ağırlıkları, bilgisayarla hesaplanmış teorik ağırlıklardır.

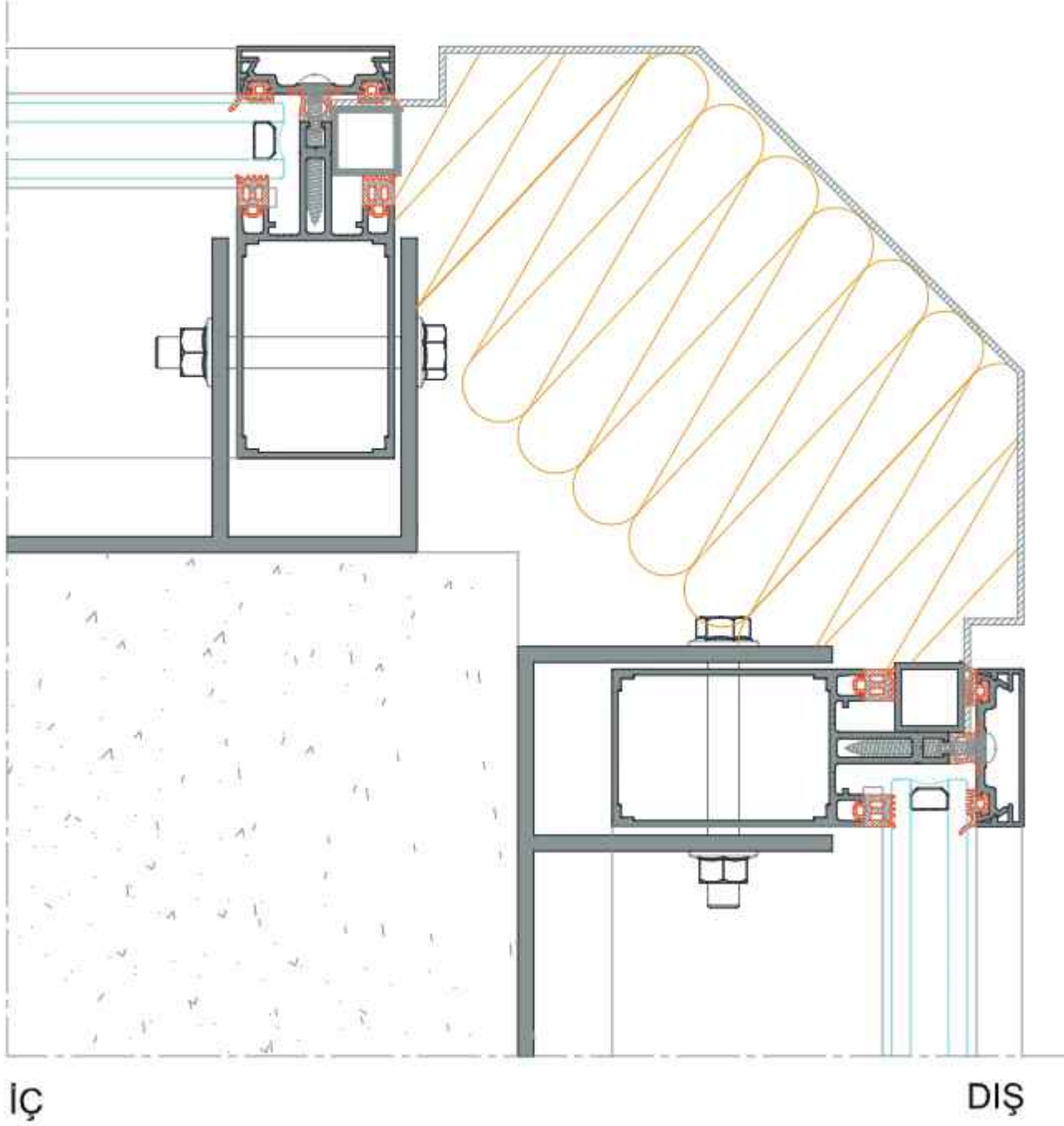

DETAY- 1
ÖLÇEKSİZ



★ Yandaki profil birim ağırlıkları, bilgisayarla hesaplanmış teorik ağırlıklardır.

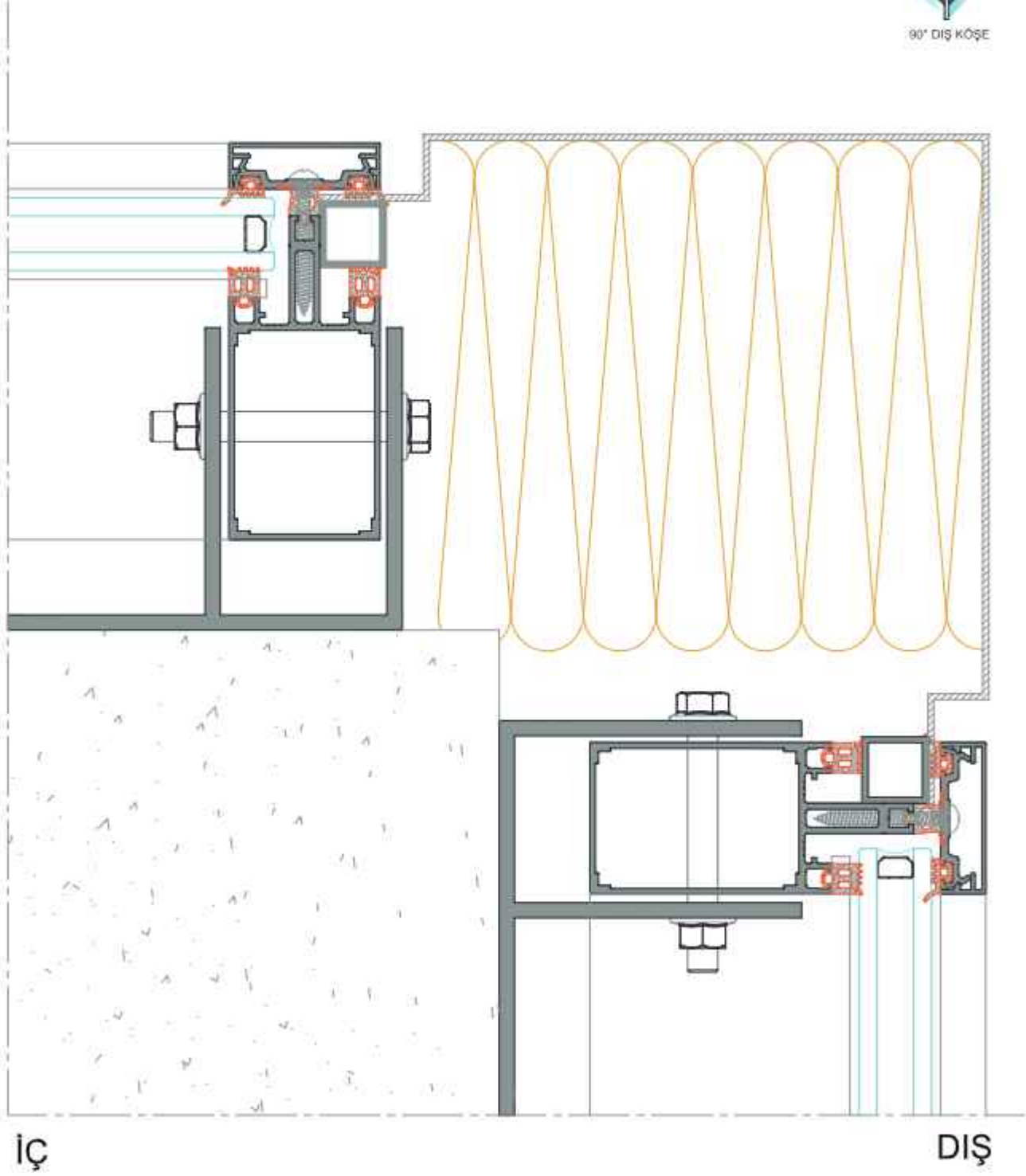

DETAY- 1
ÖLÇEK:1/1

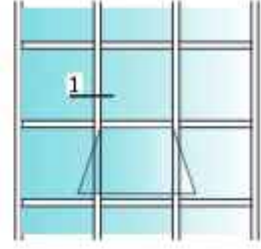

★ Yandaki profil birim ağırlıkları, bilgisayarla hesaplanmış teorik ağırlıklardır.

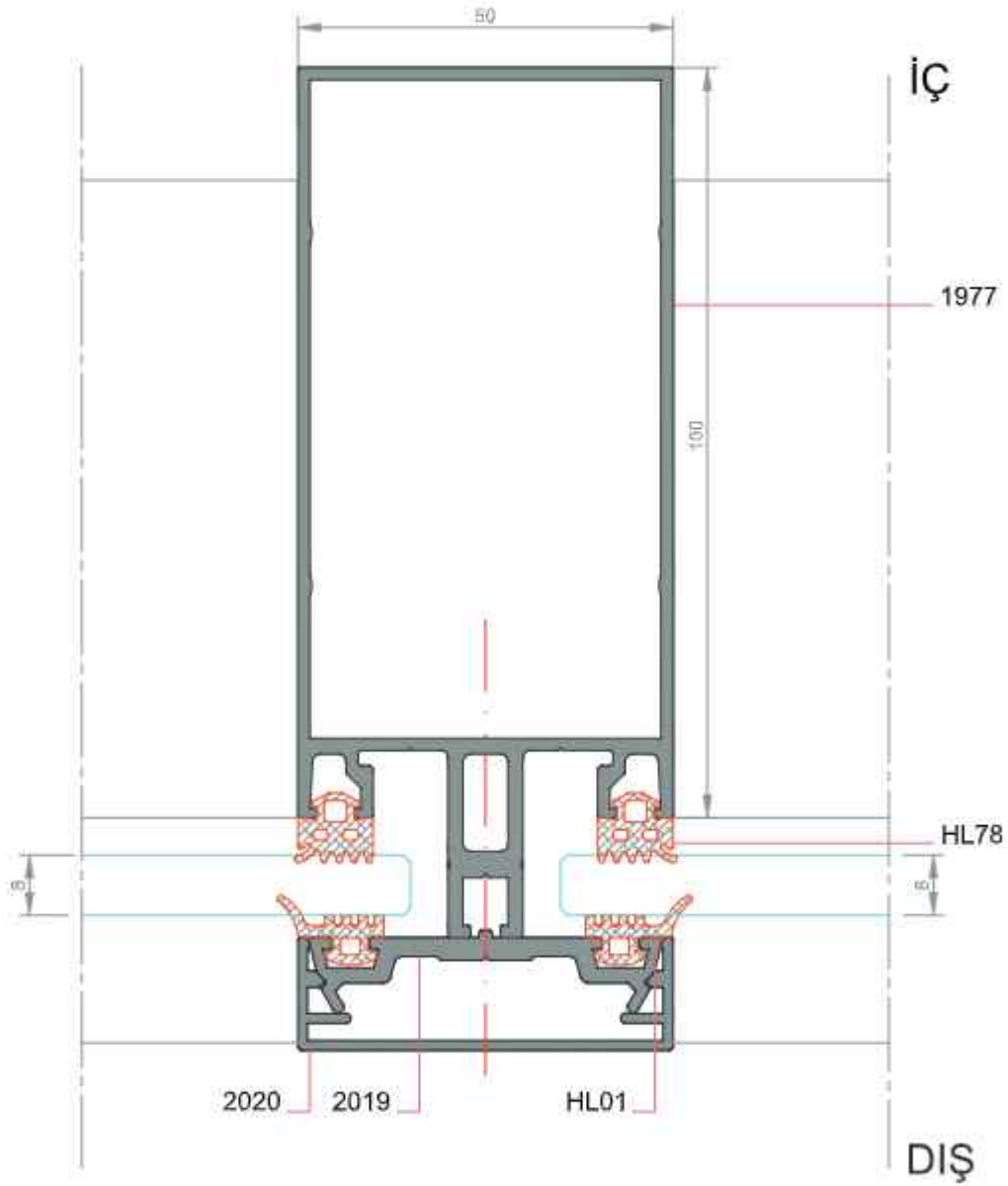

DETAY- 2

ÖLÇEK:1/1

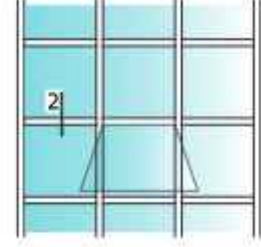

★ Yandaki profil birim ağırlıkları, bilgisayarla hesaplanmış teorik ağırlıklardır.

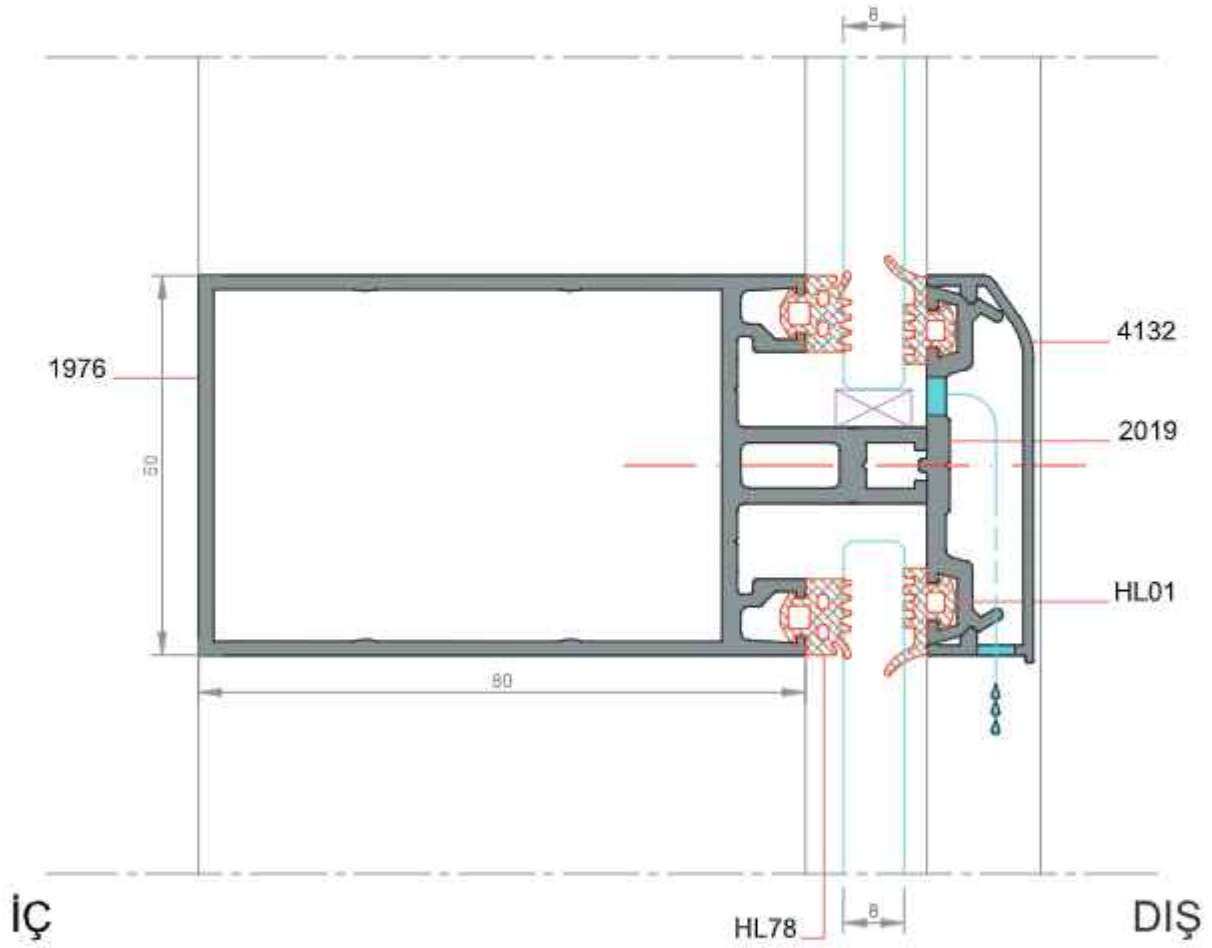

DETAY-1
ÖLÇEK:1/1

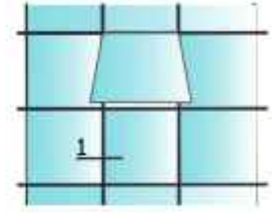

★ Yandaki profil birim ağırlıkları, bilgisayarla hesaplanmış teorik ağırlıklardır.

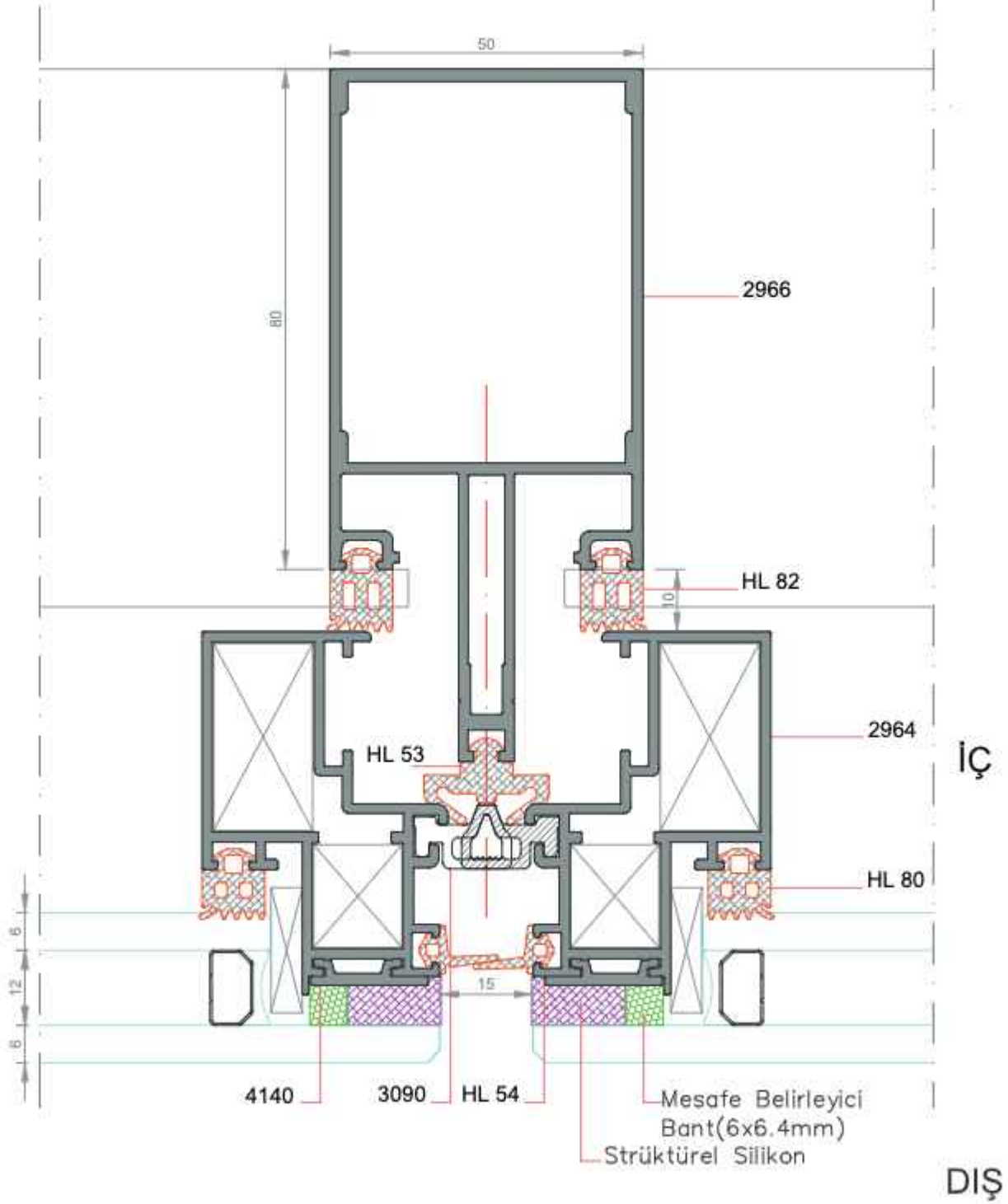

NOT: Mesafe belirleyici bant ve strüktürel silikon, cam yapıştırma firmasına aittir.
Özel ortamda, test edilerek uygulanmalıdır, aksi takdirde güvenliği kabul edilemez.

DETAY-2

ÖLÇEK:1/1

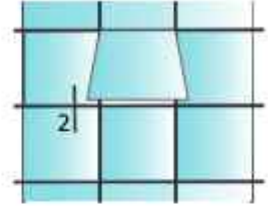

★ Yandaki profil birim ağırlıkları, bilgisayarla hesaplanmış teorik ağırlıklardır.

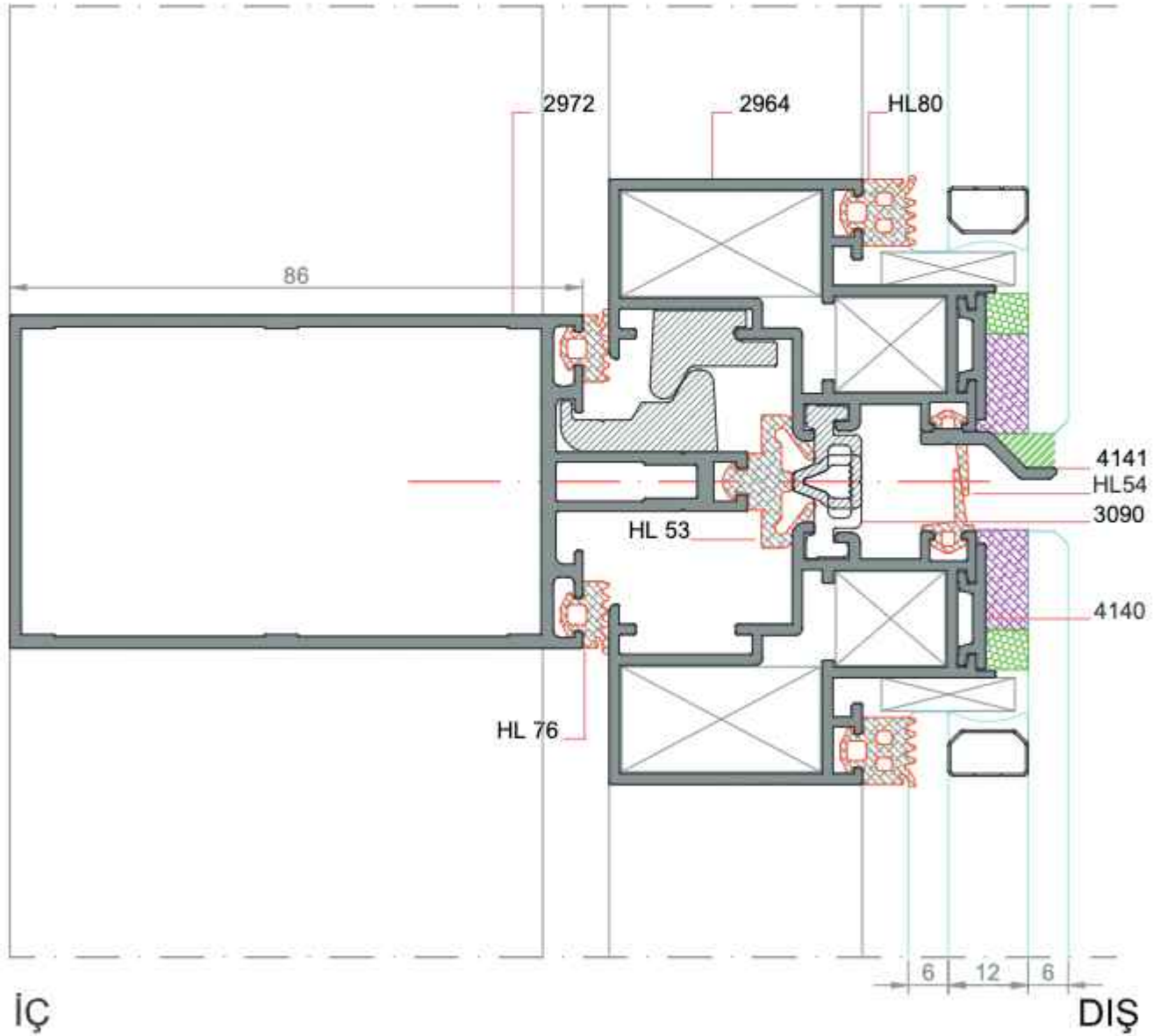

NOT: Mesafe belirleyici bant ve strüktürel silikon, cam yapıştırma firmasına aittir.
Özel ortamda, test edilerek uygulanmalıdır, aksi takdirde güvenliği kabul edilemez.

DETAY-4a

ÖLÇEK:1/1

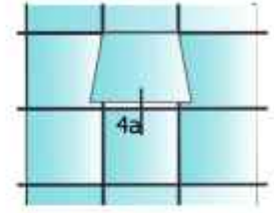

★ Yandaki profil birim ağırlıkları, bilgisayarla hesaplanmış teorik ağırlıklardır.

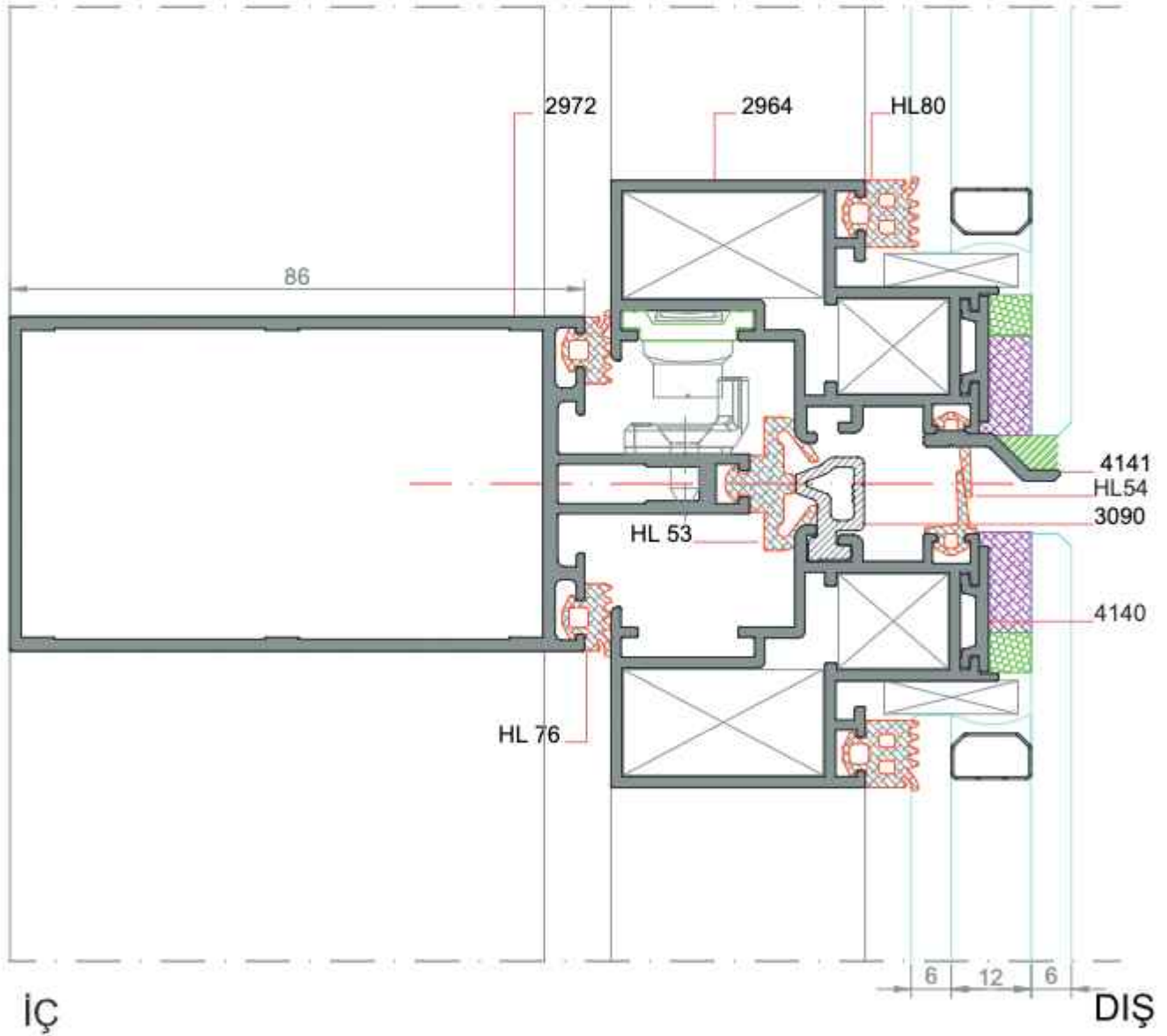

NOT: Mesafe belirleyici bant ve strüktürel silikon,cam yapıştırma firmasına aittir.
Özel ortamda, test edilerek uygulanmalıdır, aksi takdirde güvenliği kabul edilemez.

DETAY-4b

ÖLÇEK:1/1

★ Yandaki profil birim ağırlıkları, bilgisayarda hesaplanmış teorik ağırlıklardır.

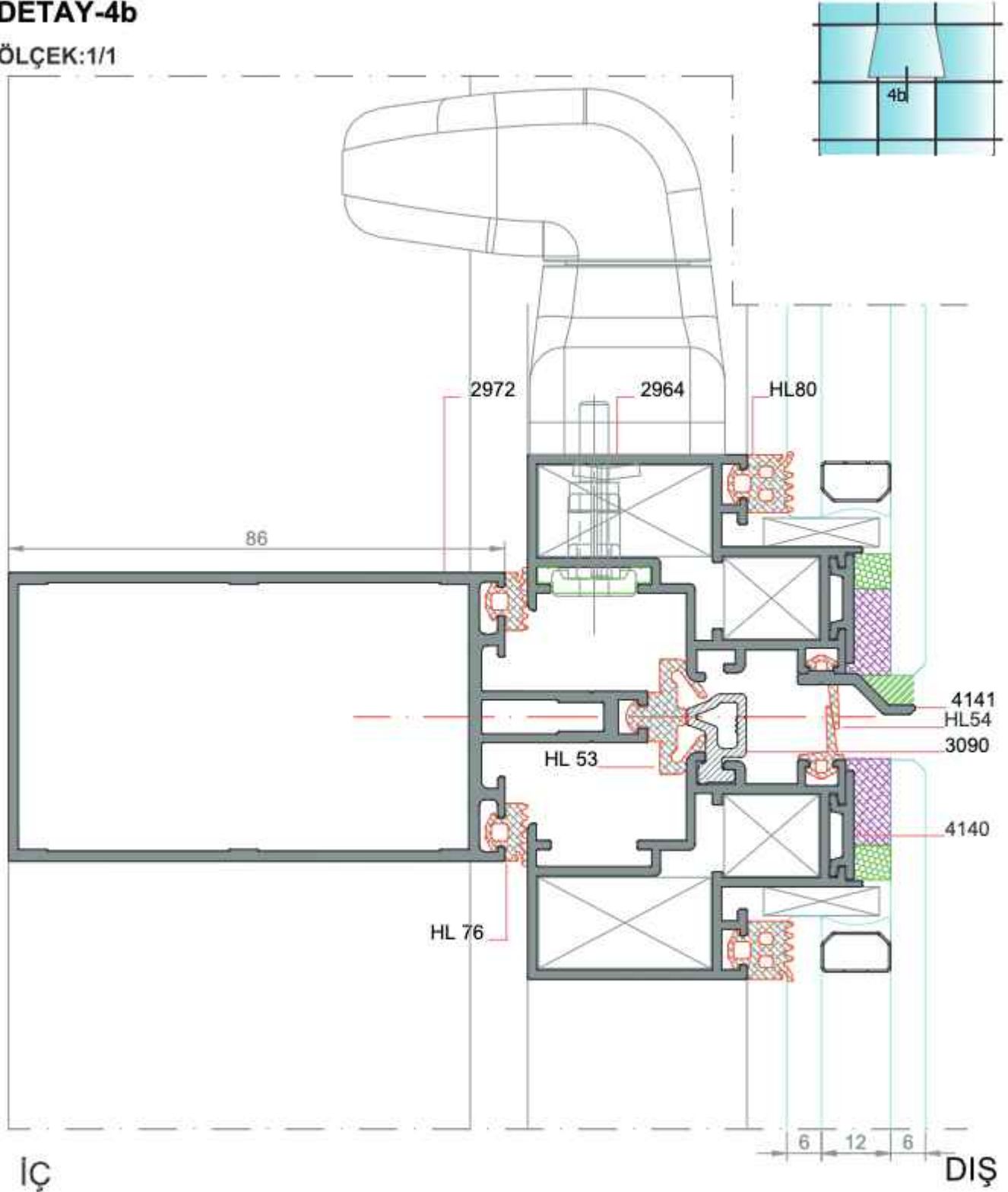

NOT: Mesafe belirleyici bant ve strüktürel silikon, cam yapıştırma firmasına aittir.
Özel ortamda, test edilerek uygulanmalıdır, aksi takdirde güvenliği kabul edilemez.

DETAY-5
ÖLÇEK:1/1

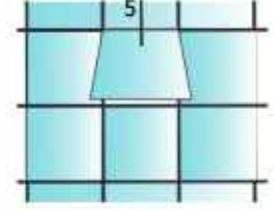

★ Yandaki profil birim ağırlıkları, bilgisayarla hesaplanmış teorik ağırlıklardır.

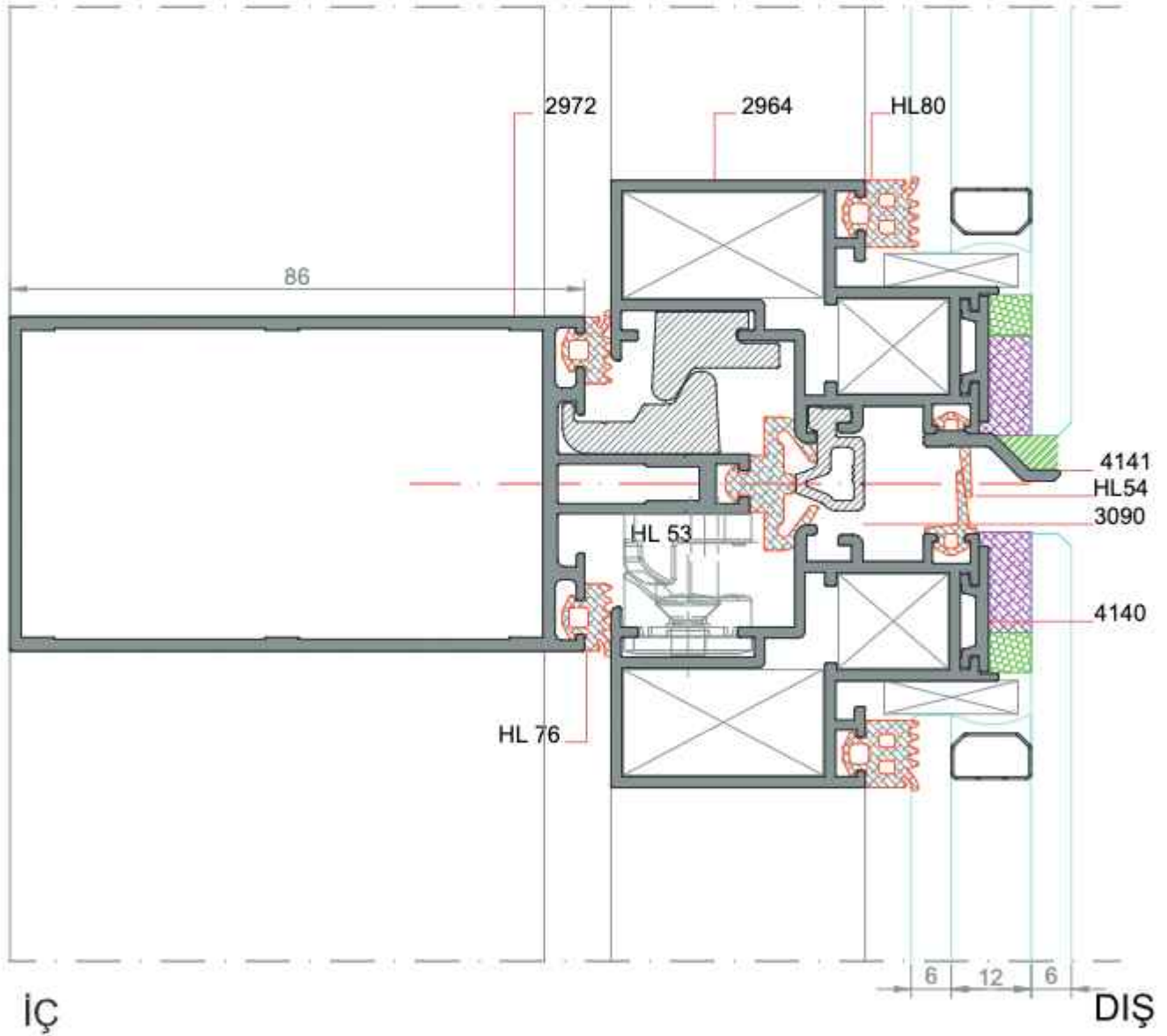

NOT: Mesafe belirleyici bant ve strüktürel silikon,cam yapıştırma firmasına aittir.
Özel ortamda, test edilerek uygulanmalıdır, aksi takdirde güvenliği kabul edilemez.

DETAY-1

ÖLÇEK:1/1

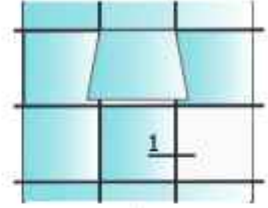

★ Yandaki profil birim ağırlıkları, bilgisayararda hesaplanmış teorik ağırlıklardır.

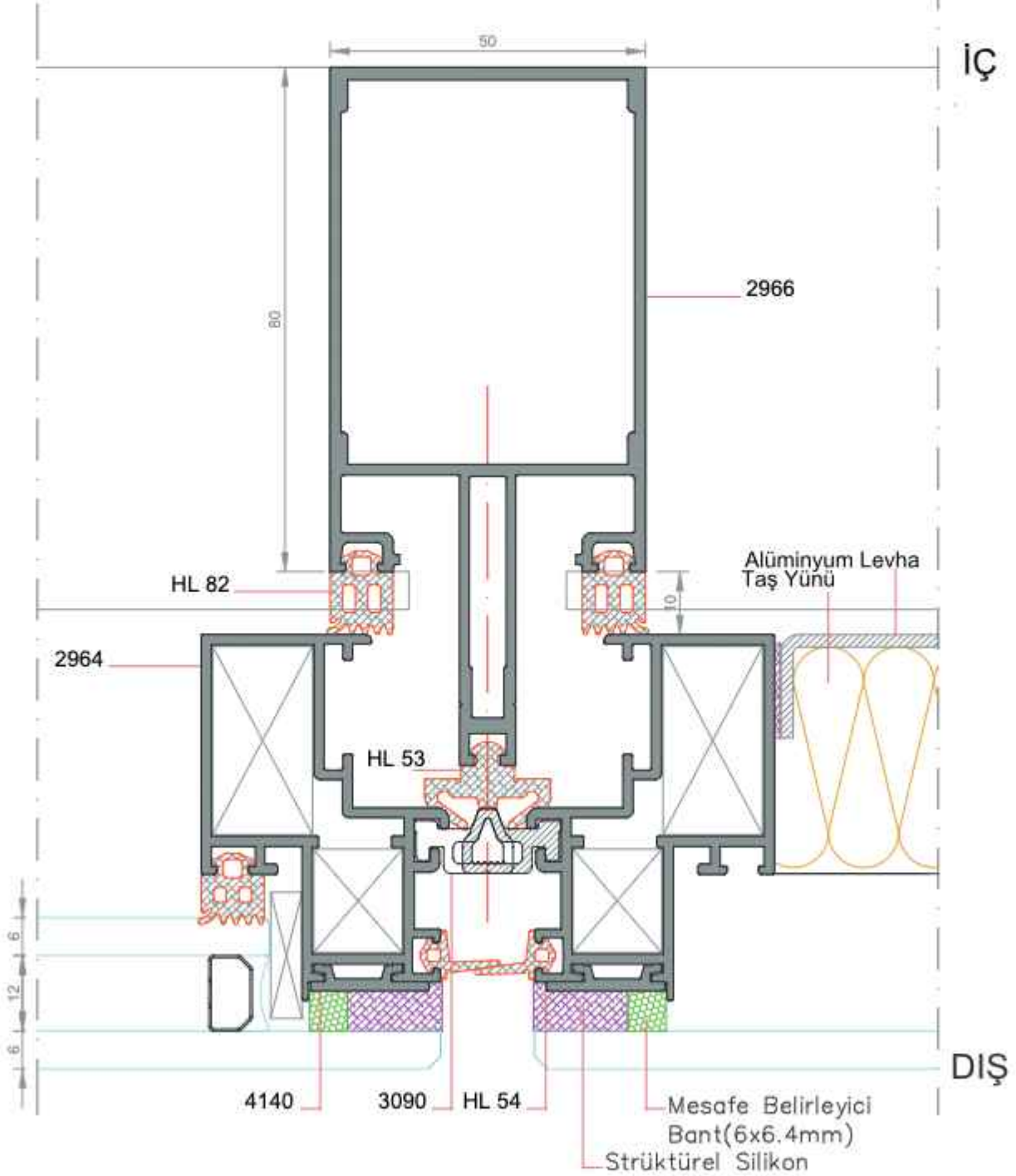

NOT: Mesafe belirleyici bant ve strüktürel silikon, cam yapıştırma firmasına aittir.
Özel ortamda, test edilerek uygulanmalıdır, aksi takdirde güvenliği kabul edilemez.

DETAY-2
ÖLÇEK:1/1

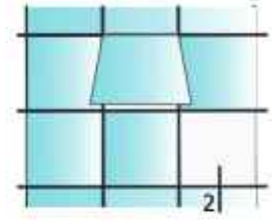

★ Yandaki profil birim ağırlıkları, bilgisayarla hesaplanmış teorik ağırlıklardır.

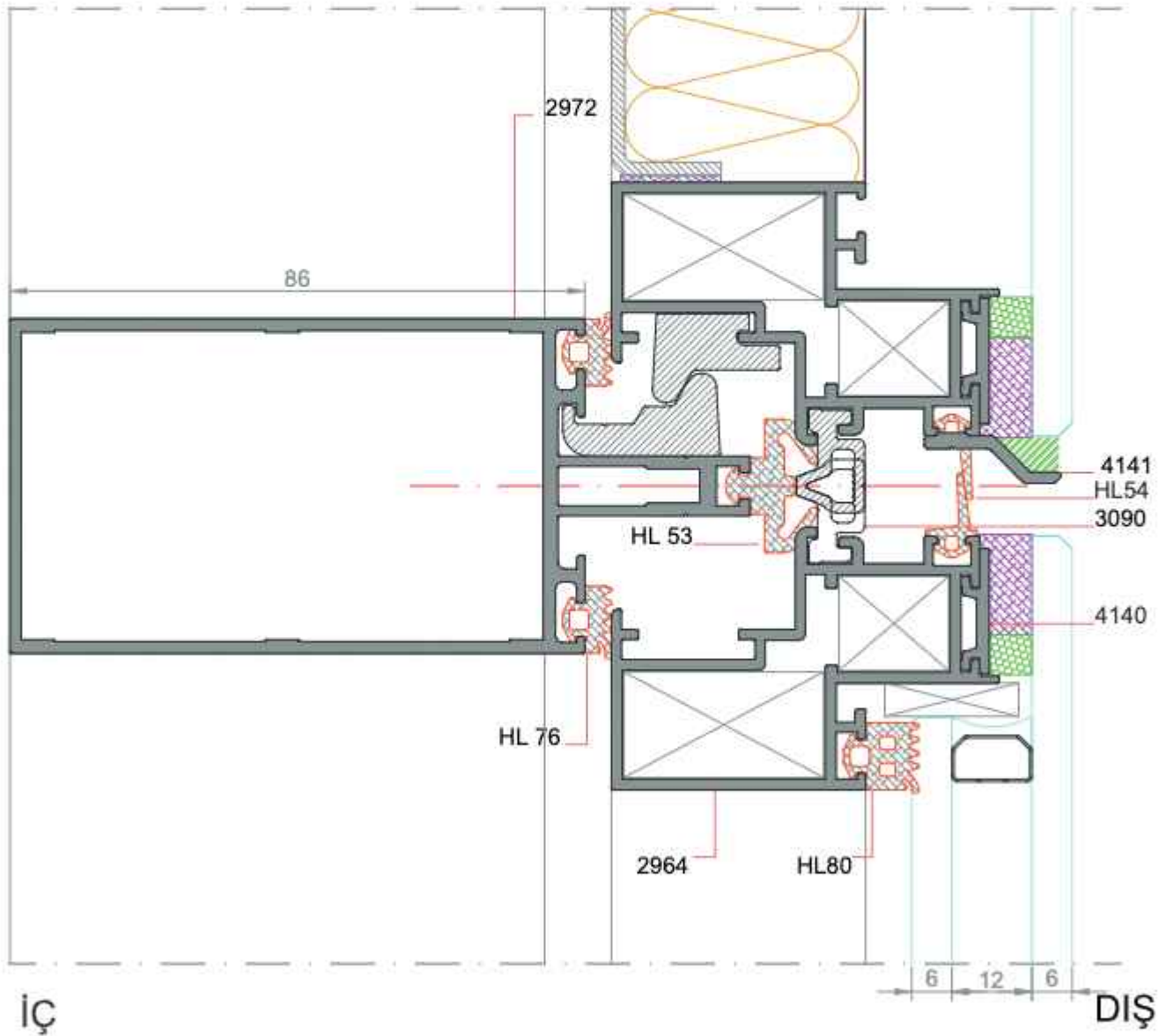

NOT: Mesafe belirleyici bant ve strüktürel silikon,cam yapıştırma firmasına aittir.
Özel ortamda, test edilerek uygulanmalıdır, aksi takdirde güvenliği kabul edilemez.

DETAY-1

ÖLÇEK: 1/1

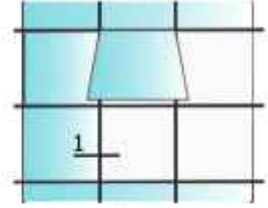

★ Yandaki profil birim ağırlıkları, bilgisayar yardımıyla hesaplanmış teorik ağırlıklardır.

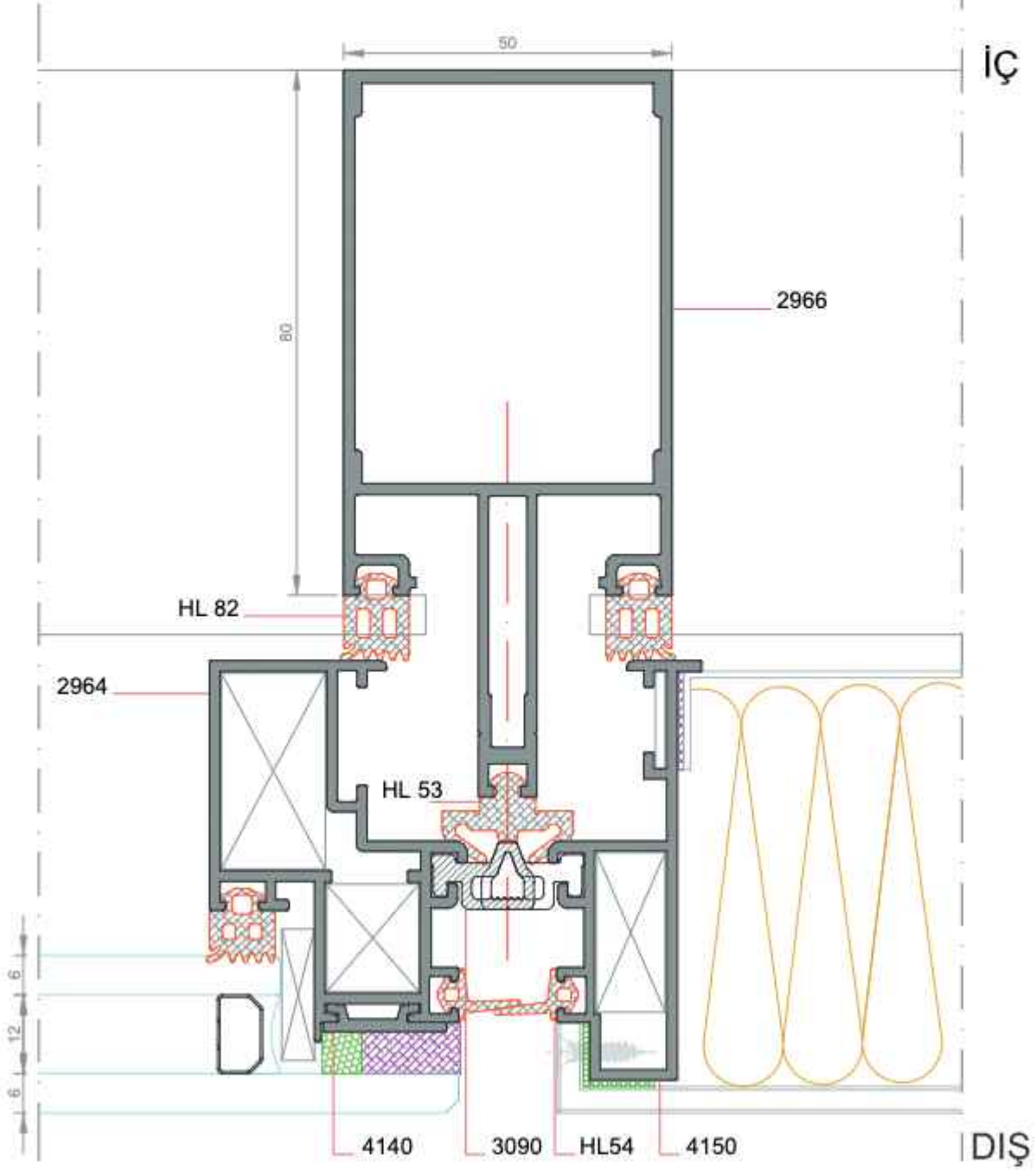

NOT: Mesafe belirleyici bant ve strüktürel silikon, cam yapıştırma firmasına aittir.
Özel ortamda, test edilerek uygulanmalıdır, aksi takdirde güvenliği kabul edilemez.

DETAY-2
ÖLÇEK:1/1

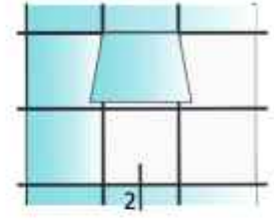

★ Yandaki profil birim ağırlıkları, bilgisayarla hesaplanmış teorik ağırlıklardır.

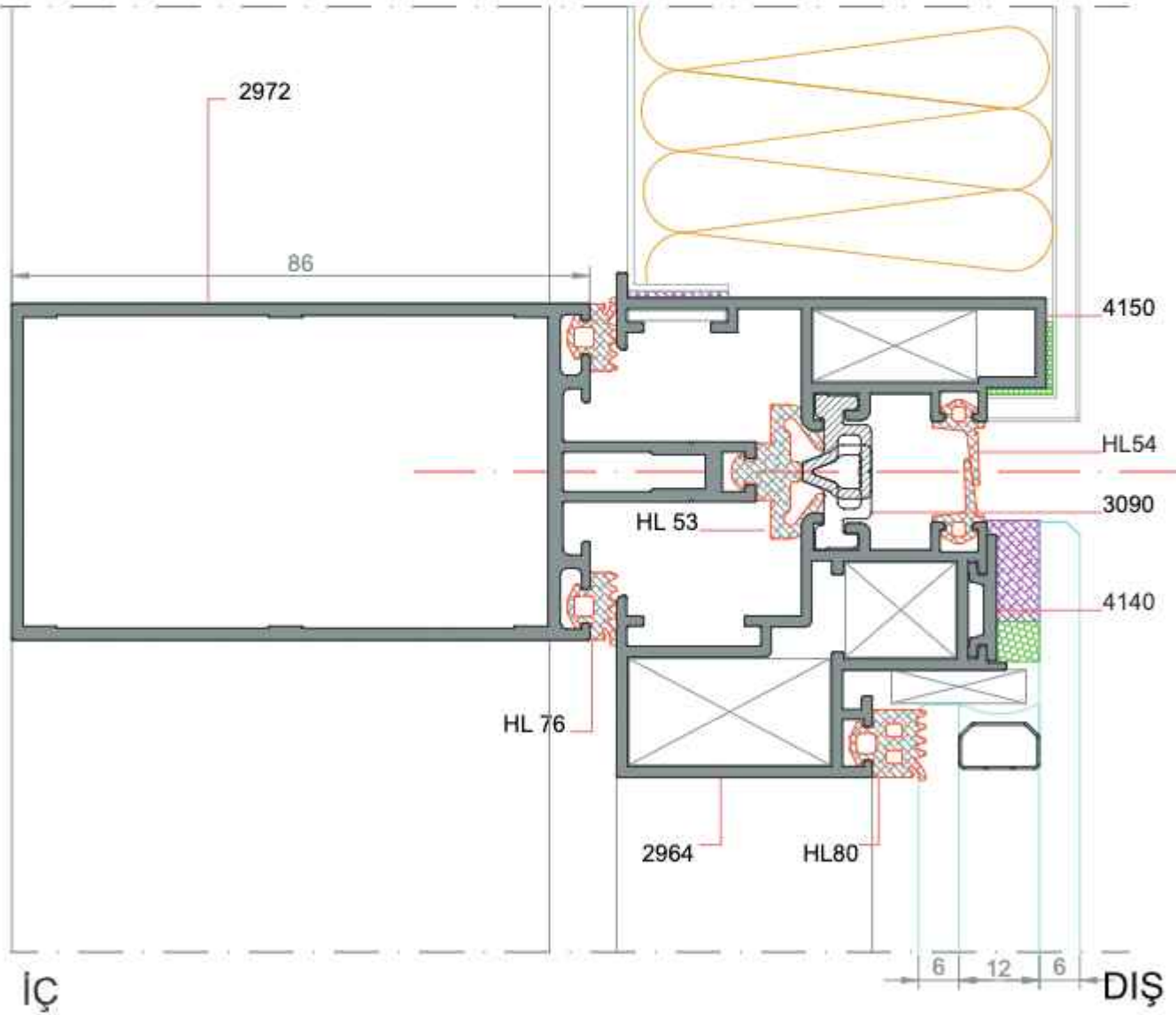

NOT: Mesafe belirleyici bant ve strüktürel silikon,cam yapıştırma firmasına aittir.
Özel ortamda, test edilerek uygulanmalıdır, aksi takdirde güvenliği kabul edilemez.

DETAY-3

ÖLÇEK:1/1

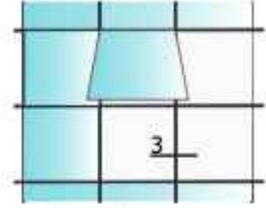

★ Yandaki profil birim ağırlıkları, bilgisayarla hesaplanmış teorik ağırlıklardır.

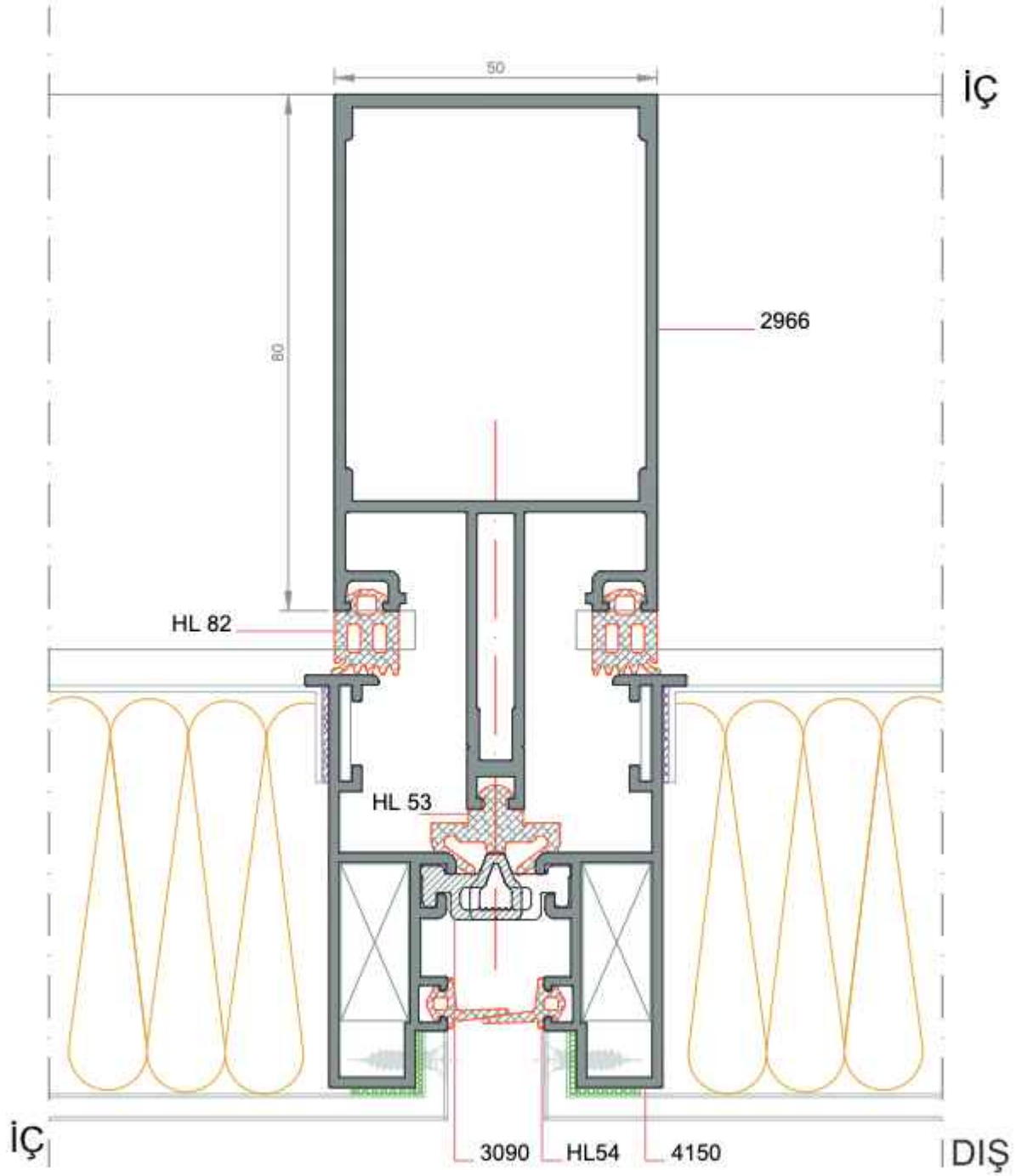

DETAY-2

ÖLÇEK:1/1

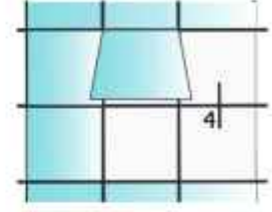

★ Yandaki profil birim ağırlıkları, bilgisayarla hesaplanmış teorik ağırlıklardır.

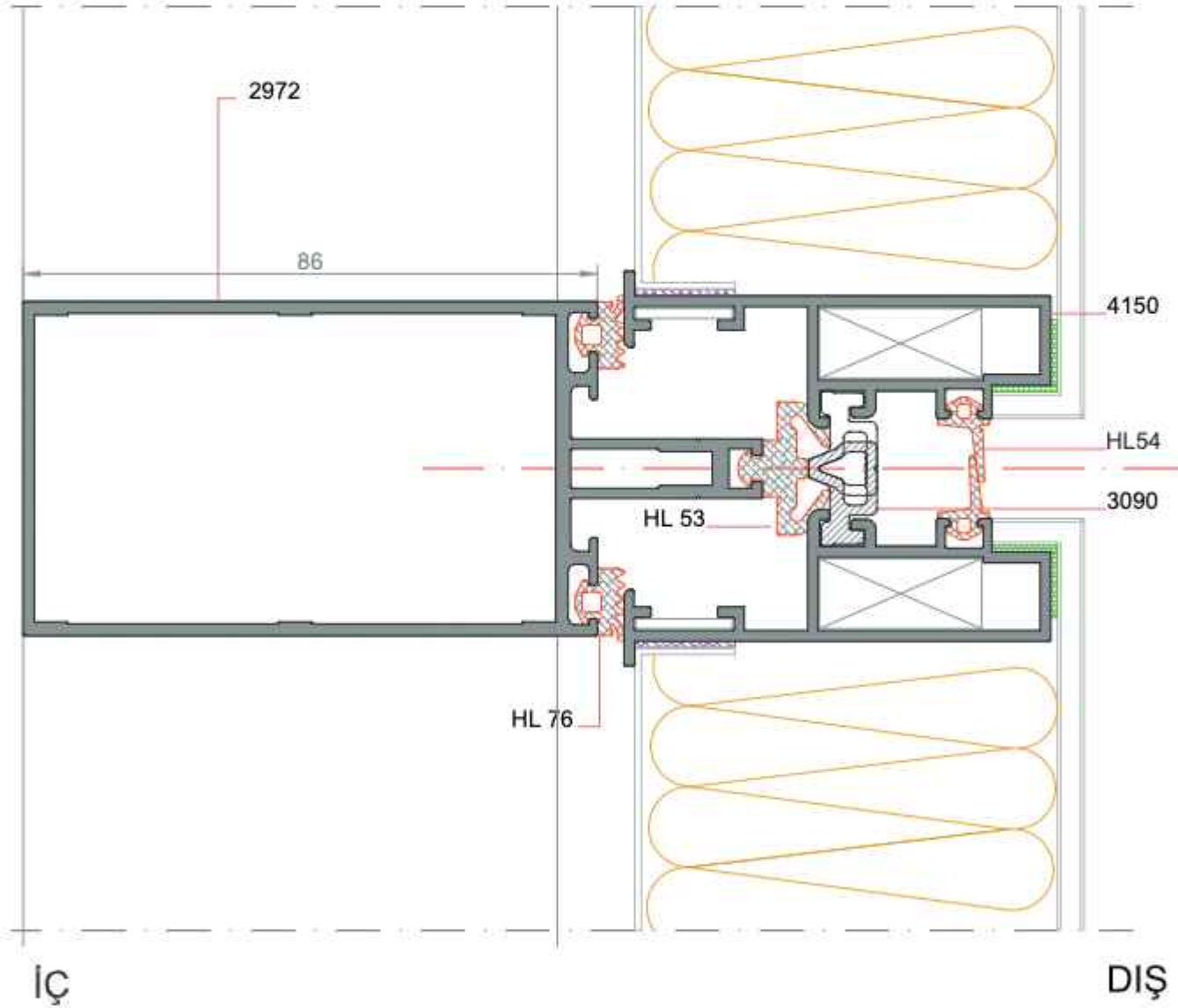

DETAY-1

ÖLÇEK:1/1

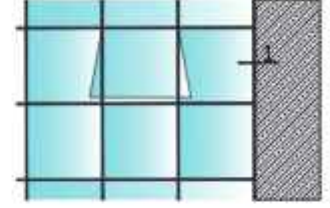

İÇ

★ Yandaki profil birim ağırlıkları, bilgisayarla hesaplanmış teorik ağırlıklardır.

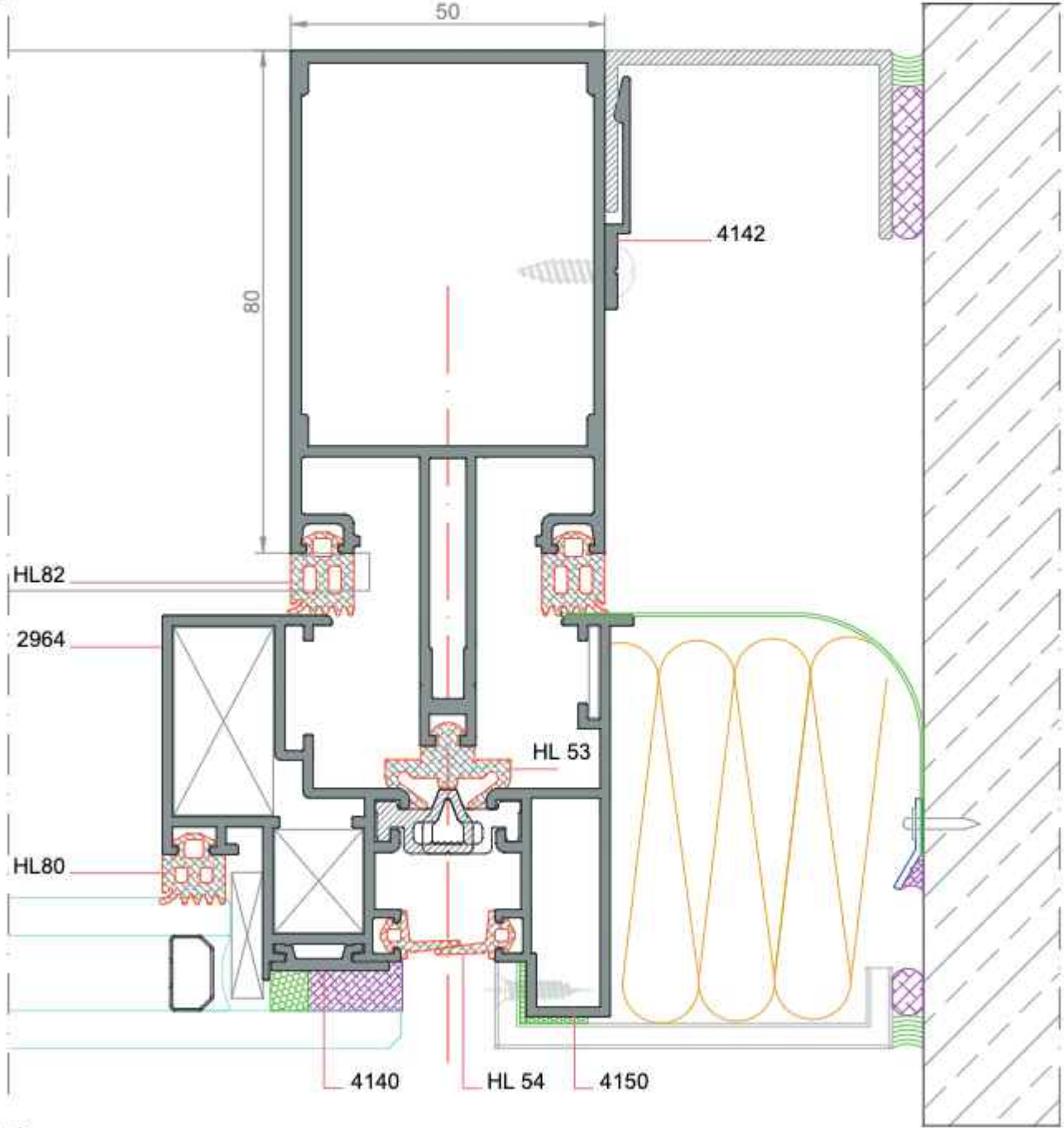

DIŞ

NOT: Mesafe belirleyici bant ve strüktürel silikon, cam yapıştırma firmasına aittir.
Özel ortamda, test edilerek uygulanmalıdır, aksi takdirde güvenliği kabul edilemez.

DETAY-1

ÖLÇEK: 1:25

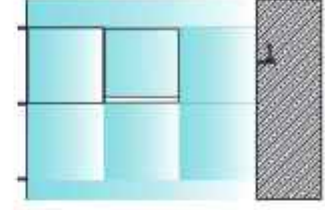

★ Yandaki profil birim ağırlıkları, bilgisayarda hesaplanmış teorik ağırlıklardır.

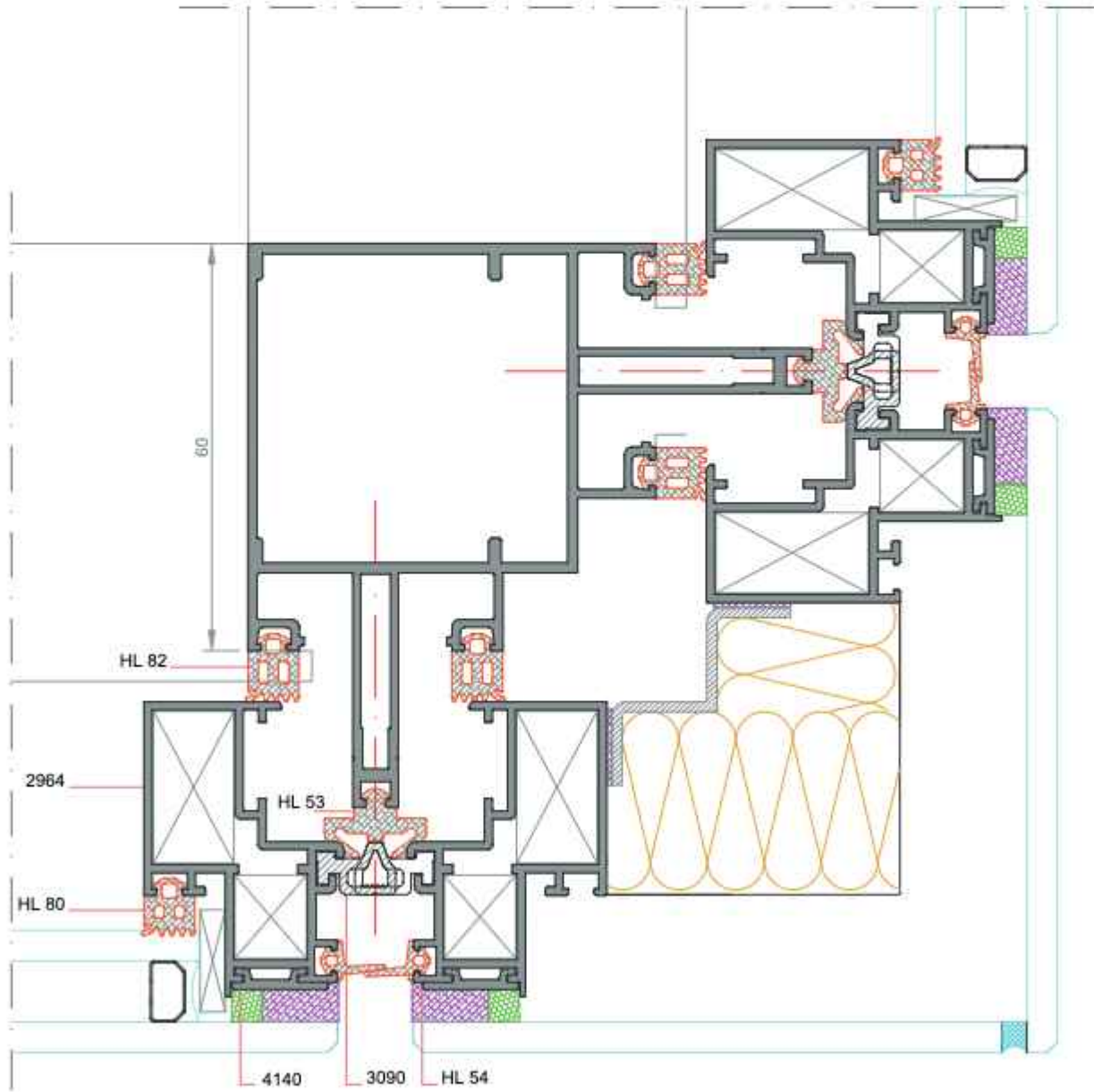

DETAY-1
ÖLÇEKSİZ



★ Yandaki profil birim ağırlıkları, bilgisayarda hesaplanmış teorik ağırlıklardır.

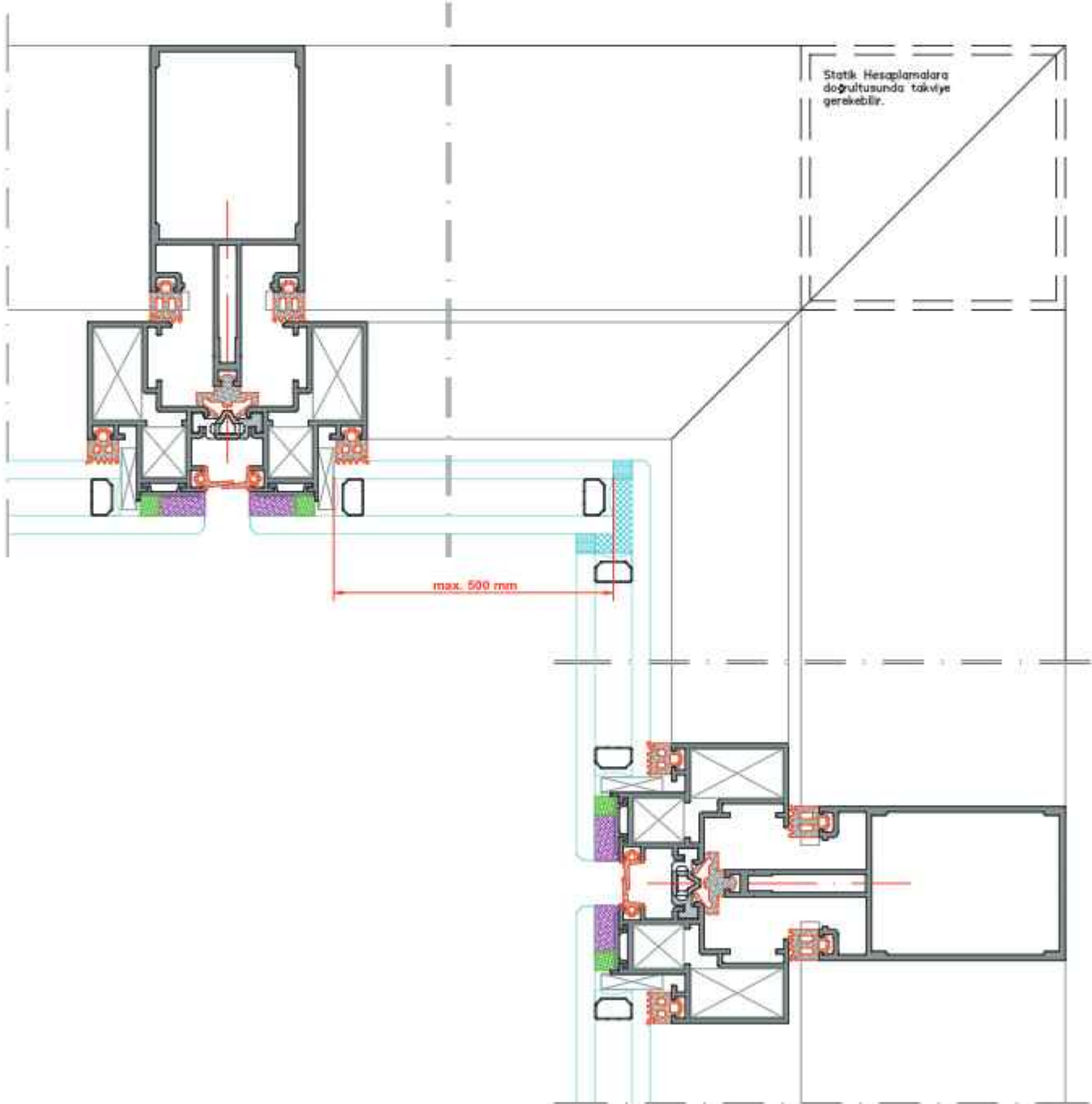

DETAY-1
ÖLÇEKSİZ



90° DIŞ KÖŞE

★ Yandaki profil birim ağırlıkları, bilgisayarla hesaplanmış teorik ağırlıklardır.

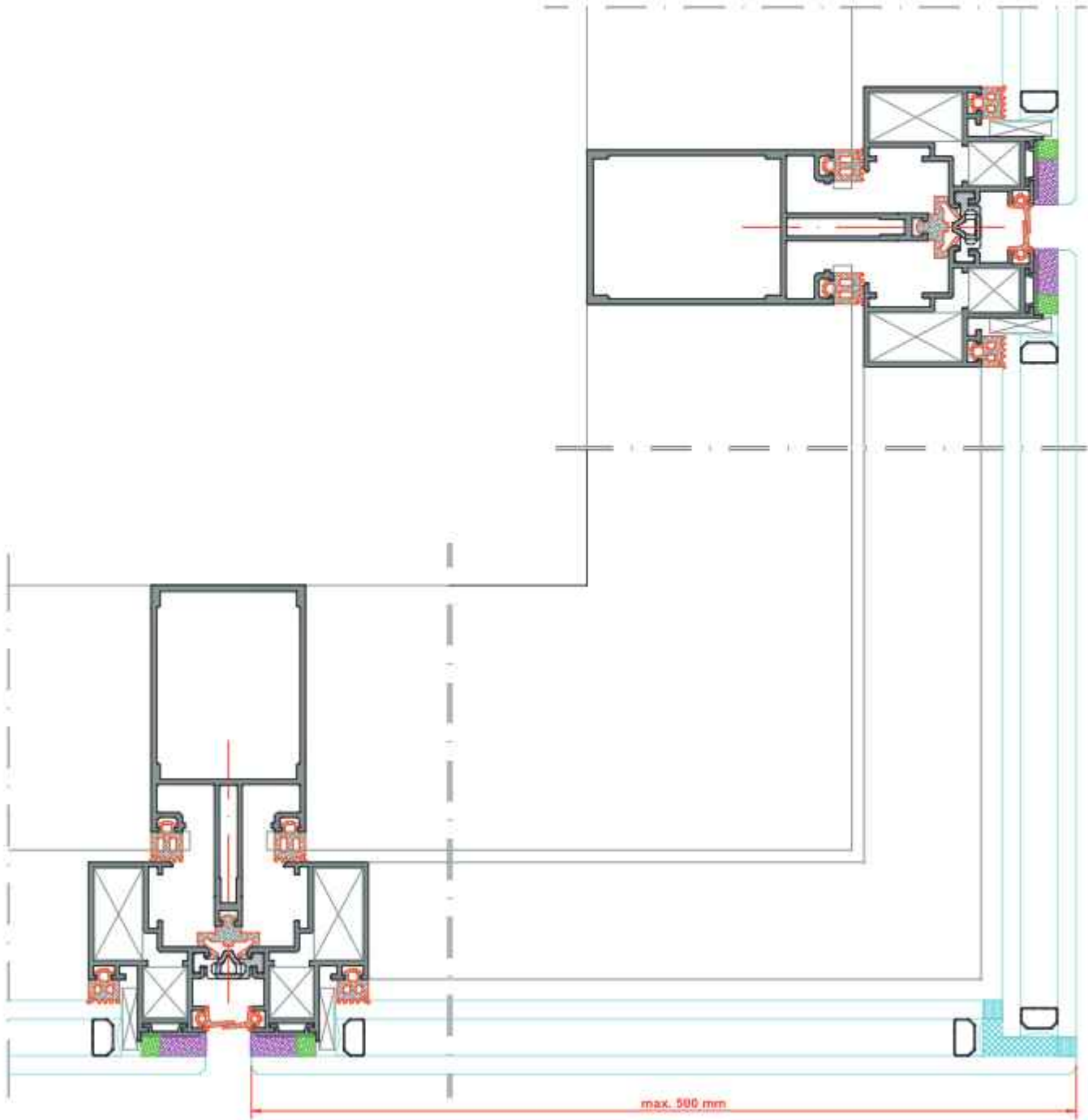

CAM ALTI DESTEK TAKOZU KESİM ÖLÇÜLERİ

* Uygulanacak cam altı destek takozu adeti kaset ölçü ve ağırlığı dikkate alınarak statik hesaplamalarla belirlenmelidir. (min. 2 adet)

* Kaset dış kenarlarından 150 mm mesafede uygulanmalıdır.

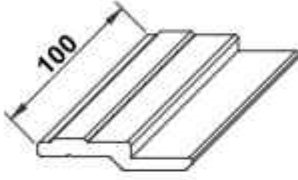

K4141 0100

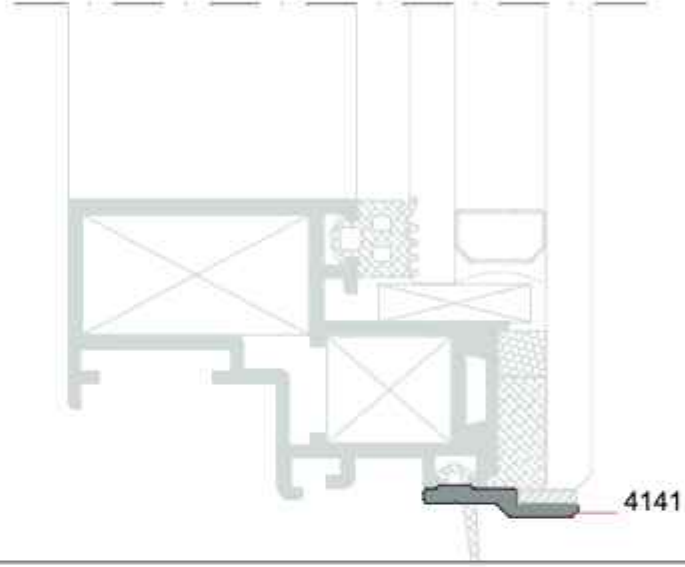

SİLİKON CEPHE BAĞLANTI PROFİLİ KESİM ÖLÇÜLERİ

* Rüzgar yükü , kanat ölçü ve ağırlığı dikkate alınarak statik hesaplama ile kullanılacak adetler belirlenmelidir.

* Kanat dış kenarlarından 150 mm mesafede ve devamında 400 mm aralıklarda kullanılmalıdır.

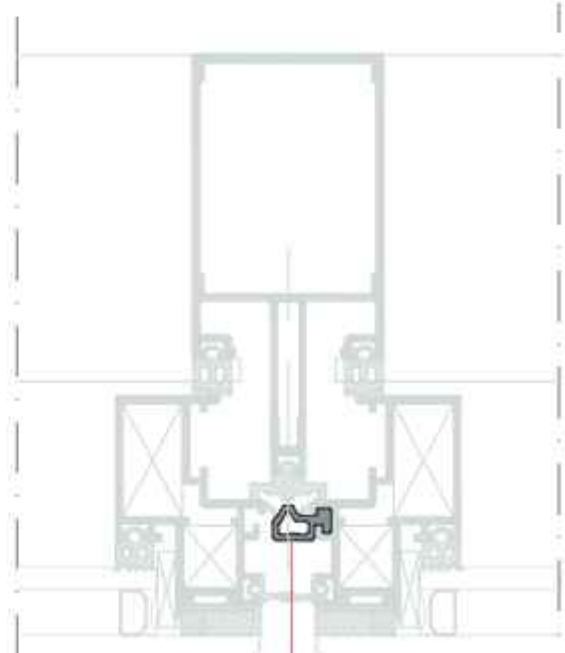
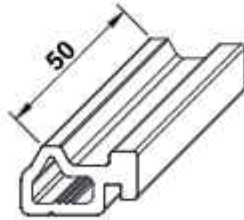

★ Yandaki profil birim ağırlıkları, bilgisayarla hesaplanmış teorik ağırlıklardır.



PROFİL KATALOĐU











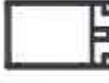

GXY H50 SG CAM İÇİ KİLİTME SİSTEMLERİ

INTERLOCKING GLASS SYSTEMS



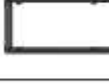

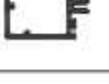





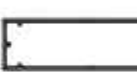

* Profil Ađırlıkları Teorik Olup Teslim Anındaki Ađırlık Geerlidir

* *Weight of profiles are theoretical, net weight will valid at the time of delivery.*

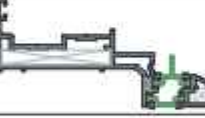
★ Yandaki profil birim ağırlıkları, bilgisayarda hesaplanmış teorik ağırlıklardır.

PROFİL KESİTİ	PROFİL KODU	PROFİL ADI	AĞIRLIK	ATALET MOMENTLERİ		SAYFA NO
				J_x (cm ⁴)	J_y (cm ⁴)	
	4300	50'lik Düşey Profil	1,617 kg/m	22,46	16,67	
	4301	60'lik Düşey Profil	1,788 kg/m	36,46	19,38	
	4302	80'lik Düşey Profil	2,067 kg/m	74,98	24,40	
	4303	100'lük Düşey Profil	2,301 kg/m	126,62	29,33	
	4304	120'lik Düşey Profil	2,518 kg/m	194,67	33,94	
	4305	140'lik Düşey Profil	2,860 kg/m	306,93	39,97	
	4306	150'lik Düşey Profil	3,082 kg/m	383,17	42,31	
	4307	160'lik Düşey Profil	3,324 kg/m	458,58	46,39	
	4308	180'lik Düşey Profil	3,776 kg/m	630,96	54,73	
	4309	200'lük Düşey Profil	4,392 kg/m	891,73	64,57	
	4808	50'lik Yatay Profil	1,323 kg/m	19,97	14,96	
	4310	55'lik Yatay Profil	1,453 kg/m	26,20	16,91	
	4311	65'lik Yatay Profil	1,551 kg/m	38,52	19,00	
	4312	85'lik Yatay Profil	1,764 kg/m	71,86	23,53	

★ Yandaki profil birim ağırlıkları, bilgisayarda hesaplanmış teorik ağırlıklardır.

PROFİL KESİTİ	PROFİL KODU	PROFİL ADI	AĞIRLIK	ATALET MOMENTLERİ		SAYFA NO
				J_x (cm ⁴)	J_y (cm ⁴)	
	4313	105'lik Yatay Profil	1,959 kg/m	118,04	27,71	
	4314	125'lik Yatay Profil	2,154 kg/m	178,50	31,89	
	4315	145'lik Yatay Profil	2,467 kg/m	259,69	38,40	
	4316	155'lik Yatay Profil	2,576 kg/m	305,57	40,71	
	4317	165'lik Yatay Profil	2,851 kg/m	371,25	46,00	
	4318	185'lik Düşey Profil	3,105 kg/m	496,26	51,32	
	4319	205'lik Yatay Profil	3,764 kg/m	715,49	62,41	
	4321/4322	Gizli Kasa Profili	1,681 kg/m	72,50	3,58	
	4323/4324	Gizli Kanat Profili	1,589 kg/m	50,06	5,98	
	4809	Gizli Kasa Profili	0,883 kg/m	18,67	3,01	
	4810	Gizli Kanat Profili	0,911 kg/m	12,73	2,04	
	4494	Dilatasyon Profili	6,632 kg/m	630,96	54,73	
	4320	Yatay Taşıyıcı Bağlantı Profili	1,419 kg/m	
	4153	Dilatasyon Profili	0,218 kg/m	

★ Yandaki profil birim ağırlıkları, bilgisayarda hesaplanmış teorik ağırlıklardır.

PROFİL KESİTİ	PROFİL KODU	PROFİL ADI	AĞIRLIK	ATALET MOMENTLERİ		SAYFA NO
				J_x (cm ⁴)	J_y (cm ⁴)	
	4325	Özel Cam Çıtası	0,258 kg/m	
	4326	Cam Destek Profili	0,269 kg/m	
	4148	Cam Destek Profili	0,187 kg/m	
	4330	Cam Taşıyıcı Profili	0,269 kg/m	
	4327	Bağlantı Profili	0,538 kg/m	178,50	31,89	
	4328	Spandrel Kaset Profili	0,538 kg/m	
	4329	Kompozonit Panel Kaset Profili	0,538 kg/m	
	3871	Köşe Takozu	6,304 kg/m	
	3429	Köşe Takozu	4,569 kg/m	
	4332	Köşe Takozu	4,569 kg/m	
	4333	Köşe Takozu	2,472 kg/m	
	4494	Dilatasyon Profili	6,632 kg/m	
		Aksesuar Destek Takozu	0,107 kg/m	
		Isı Bariyeri (Sert PVC Ekstrüzyon)	0,104 kg/m	

PROFİL KESİTİ	PROFİL KODU	PROFİL ADI	AĞIRLIK	ATALET MOMENTLERİ		SAYFA NO
				J_x (cm ⁴)	J_y (cm ⁴)	
		Plastik Köşe Klipsi (Cam Çıtası için)	0,104 kg/m	

★ Yandaki profil birim ağırlıkları, bilgisayarda hesaplanmış teorik ağırlıklardır.





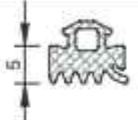
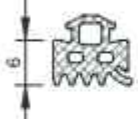
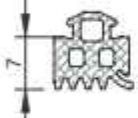
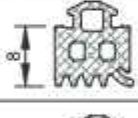
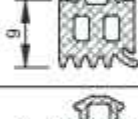
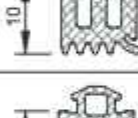
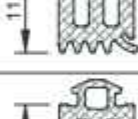
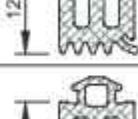
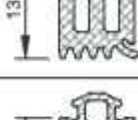
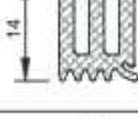
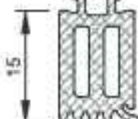

★ Yandaki profil birim ağırlıkları, bilgisayarda hesaplanmış teorik ağırlıklardır.

AKSESUAR KESİTİ	AKSESUAR KODU	AKSESUAR ADI	AĞIRLIK	PAKETLEME	SAYFA NO
	HL01	Dış Cam Fiteli	60 gr/m	15 kg/ 250 m	
	HL12	Cephe Fiteli	57 gr/m	15 kg/ 260 m	
	HL36	Cam Fiteli	96 gr/m	15 kg/ 156 m	
	HL87	Kasa Dış Fiteli	50 gr/m	15 kg/ 300 m	
	HL44	Açılı Fiteli	85 gr/m	15 kg/ 176 m	
	HL65	Baskı Fiteli	81 gr/m	15 kg/ 185 m	
	HL75	Açılı Fiteli	92 gr/m	15 kg/ 163m	
	HL53	Gaga Fiteli	166 gr/m	15 kg/ 90m	
	HL51	5.5 Yatay Fitel	75 gr/m	15 kg/ 200m	
	HL52	9.5 Düşey Fitel	107 gr/m	15 kg/140 m	
	HL106	Gizli Kanat Fiteli	52 gr/m	15 kg/ m	
	HL108	Gizli Kanat Fiteli	75 gr/m	15 kg/200 m	
	HL109	Griyaj Fiteli	80 gr/m	15 kg/187 m	
	HL54	Kaset Toz Fiteli	42 gr/m	15 kg/357 m	
	HL107	Gizli Kasa Profili	57 gr/m	15 kg/263 m	

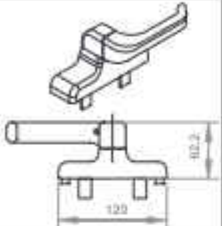
★ Yandaki profil birim ağırlıkları, bilgisayarda hesaplanmış teorik ağırlıklardır.

AKSESUAR KESİTİ	AKSESUAR KODU	AKSESUAR ADI	AĞIRLIK	PAKETLEME	SAYFA NO
	HL76	Cam Fiteli	61 gr/m	15 kg/ 245 m	
	HL77	Cam Fiteli	72 gr/m	15kg/ 208m	
	HL78	Cam Fiteli	72 gr/m	15kg/ 208m	
	HL79	Cam Fiteli	83 gr/m	15 kg/ 180m	
	HL80	Cam Fiteli	93 gr/m	15kg/ 161m	
	HL81	Cam Fiteli	107 gr/m	15kg/ 140m	
	HL56	Cam Fiteli	107 gr/m	15 kg/ 140m	
	HL82	Cam Fiteli	120 gr/m	15kg/ 125m	
	HL83	Cam Fiteli	126 gr/m	15kg/ 119m	
	HL84	Cam Fiteli	130 gr/m	15kg/ 115m	
	HL85	Cam Fiteli	141 gr/m	15kg/ 106m	
	HL86	Cam Fiteli	149 gr/m	15kg/ 100m	

★ Yandaki profil birim ağırlıkları, bilgisayarda hesaplanmış teorik ağırlıklardır.

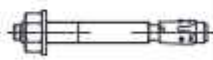
AKSESUAR KESİTİ	AKSESUAR KODU	AKSESUAR ADI	AĞIRLIK	PAKETLEME	SAYFA NO
	05007	Kıvrık Cephe Kolu	
	MP60-05/60 MP60-05/80 MP60-05/100 MP60-05/120 MP60-05/150	Ankraj	
	01269000K	Kanat Karşılığı	
	MP60-10/5	M8 Somun	
	MP60-10/5-1	M8 Pul	
	MP60-08 MP60-10	Klipsli Dübel (M10X100-M10X110) Saplama M10x90	
	GS HD10-28	Cephe Makası	
	MP60-09	M10X85 Gömlekli Dübel M10X110	

4300
Düsey Taşıyıcı Profil (50)
1,617 kg/m
Jx=22,46 cm ⁴ Jy=16,67 cm ⁴

4301
Düsey Taşıyıcı Profil (60)
1,788 kg/m
Jx=36,46 cm ⁴ Jy=19,38 cm ⁴

★ Yandaki profil birim ağırlıkları, bilgisayarda hesaplanmış teorik ağırlıklardır.

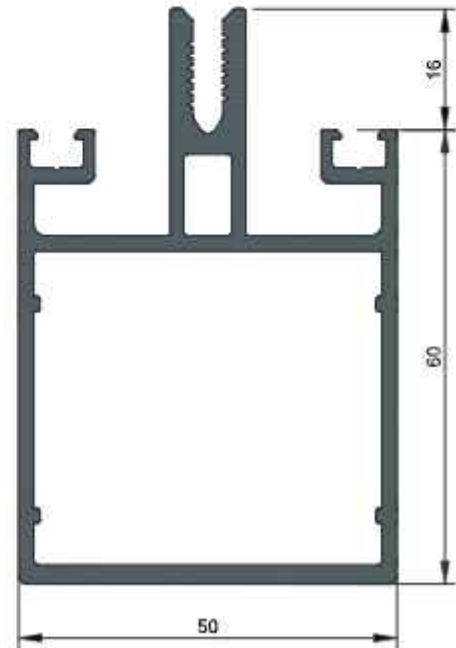
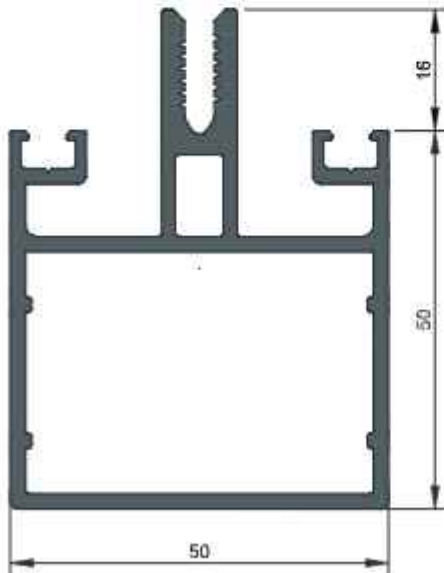

4302
Düsey Taşıyıcı Profil (80)
2,067 kg/m
Jx=74,98 cm ⁴ Jy=24,40 cm ⁴

4303
Düsey Taşıyıcı Profil (100)
2,301 kg/m
Jx=126,62 cm ⁴ Jy=29,33cm ⁴

★ Yandaki profil birim ağırlıkları, bilgisayarda hesaplanmış teorik ağırlıklardır.

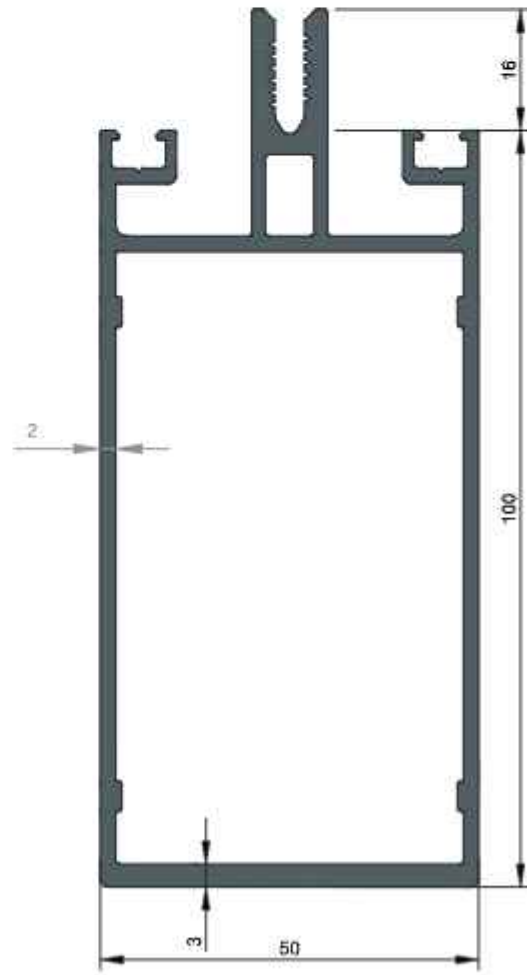
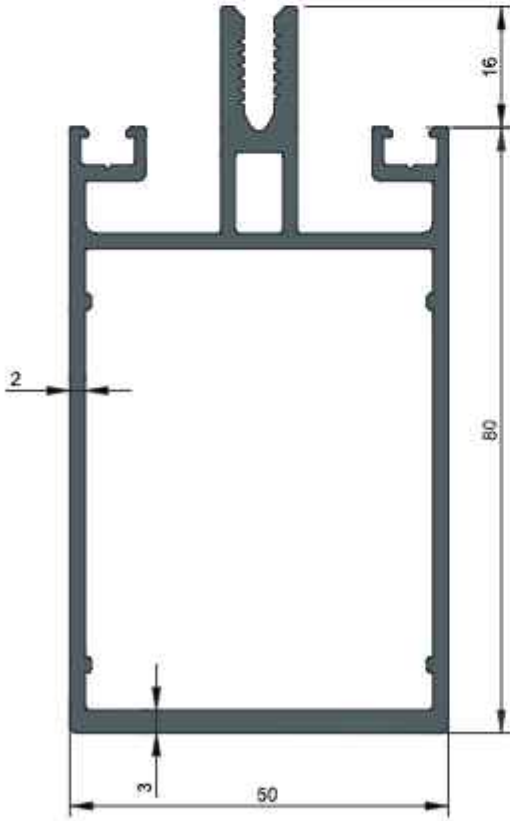

4304
Düşey Taşıyıcı Profil (120)
2,518 kg/m
$J_x=194,67 \text{ cm}^4$ $J_y=33,94 \text{ cm}^4$

4305
Düşey Taşıyıcı Profil (140)
2,860 kg/m
$J_x=306,93 \text{ cm}^4$ $J_y=39,97 \text{ cm}^4$

★ Yandaki profil birim ağırlıkları, bilgisayarda hesaplanmış teorik ağırlıklardır.

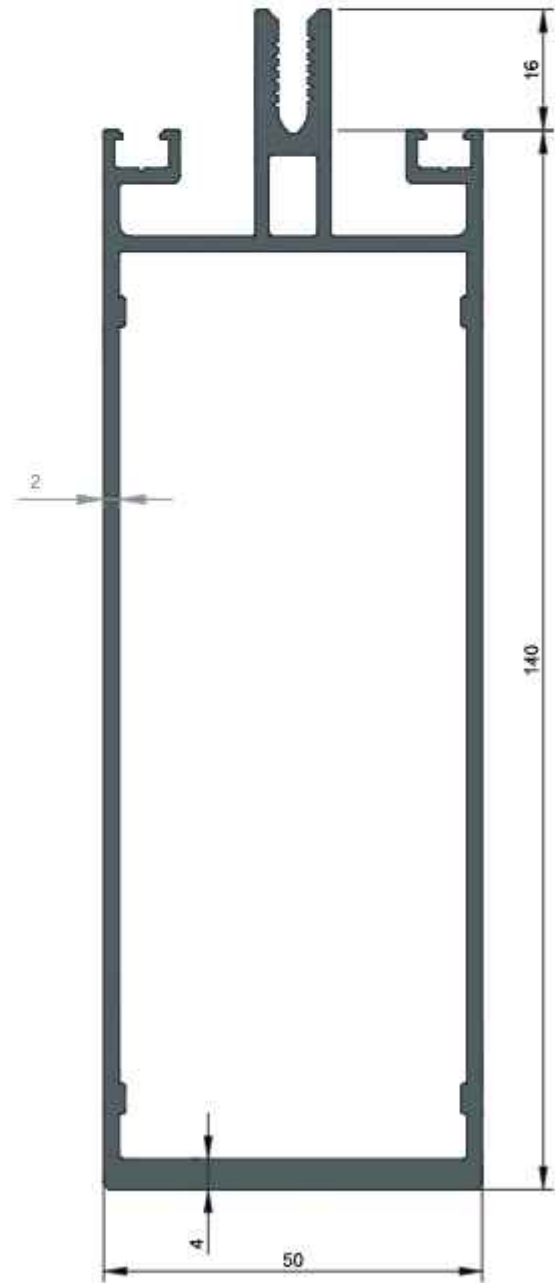
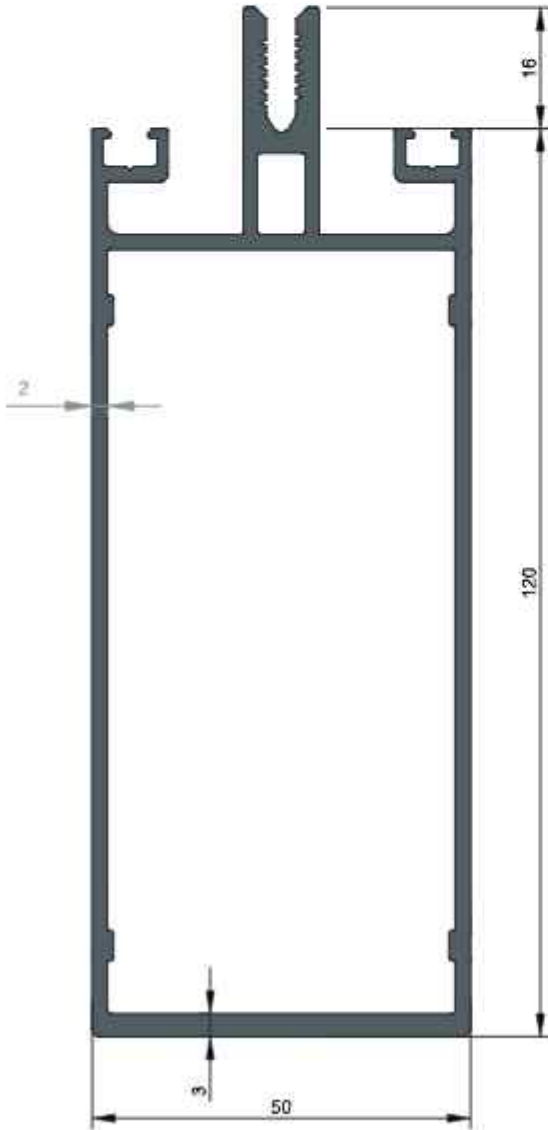

4306
Düşey Taşıyıcı Profil (150)
3,082 kg/m
Jx=383,17 cm ⁴ Jy=42,31 cm ⁴

4307
Düşey Taşıyıcı Profil (160)
3,324 kg/m
Jx=458,58 cm ⁴ Jy=46,39 cm ⁴

★ Yandaki profil birim ağırlıkları, bilgisayarda hesaplanmış teorik ağırlıklardır.

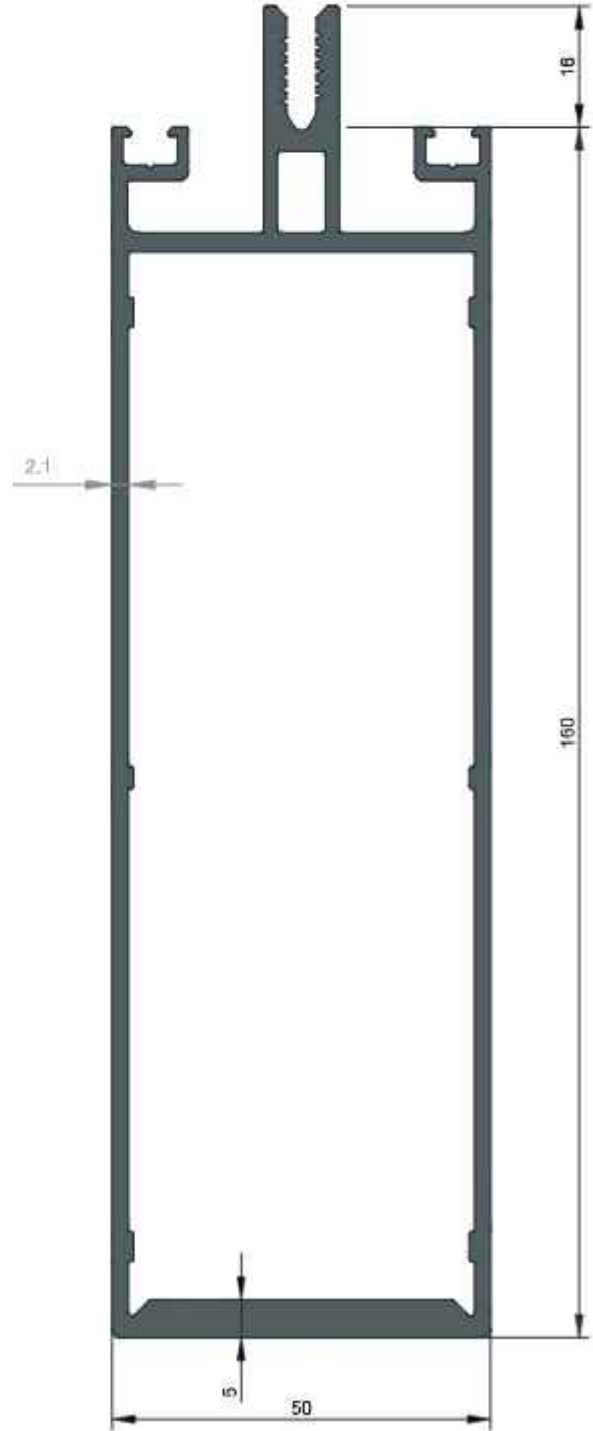
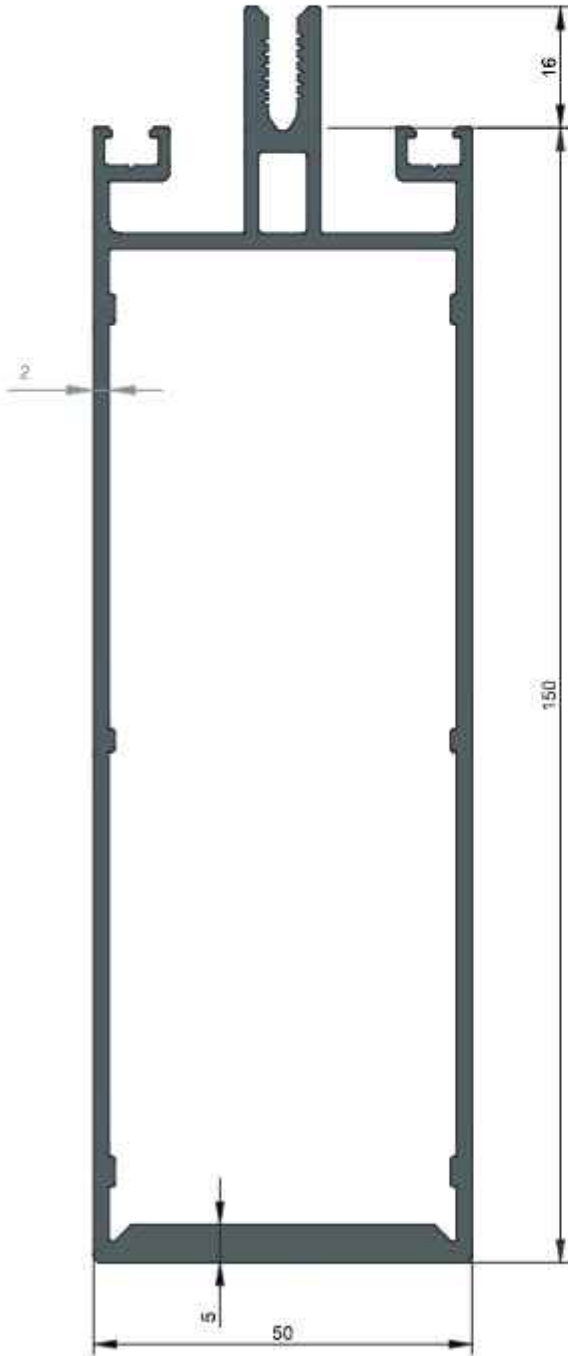

★ Yandaki profil birim ağırlıkları, bilgisayarda hesaplanmış teorik ağırlıklardır.

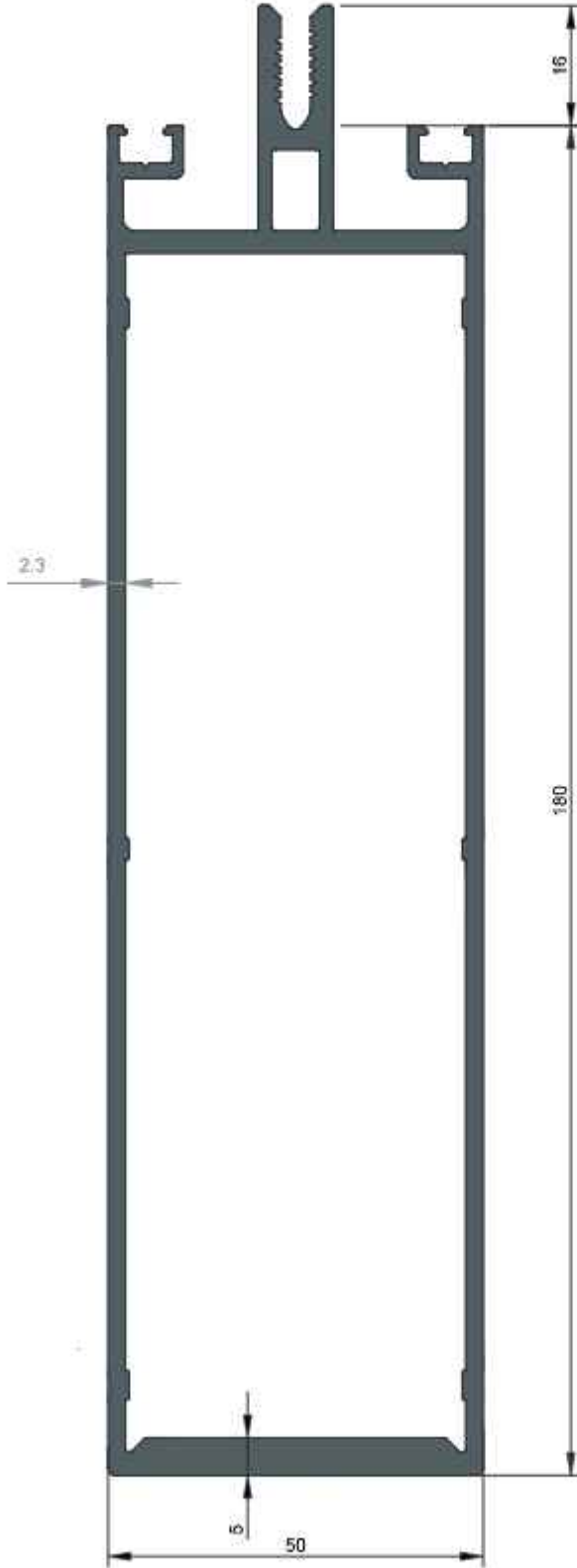

4308
Düsey Taşıyıcı Profil (180)
3,776 kg/m
$J_x=630,96 \text{ cm}^4$ $J_y=54,73 \text{ cm}^4$

★ Yandaki profil birim ağırlıkları, bilgisayarda hesaplanmış teorik ağırlıklardır.

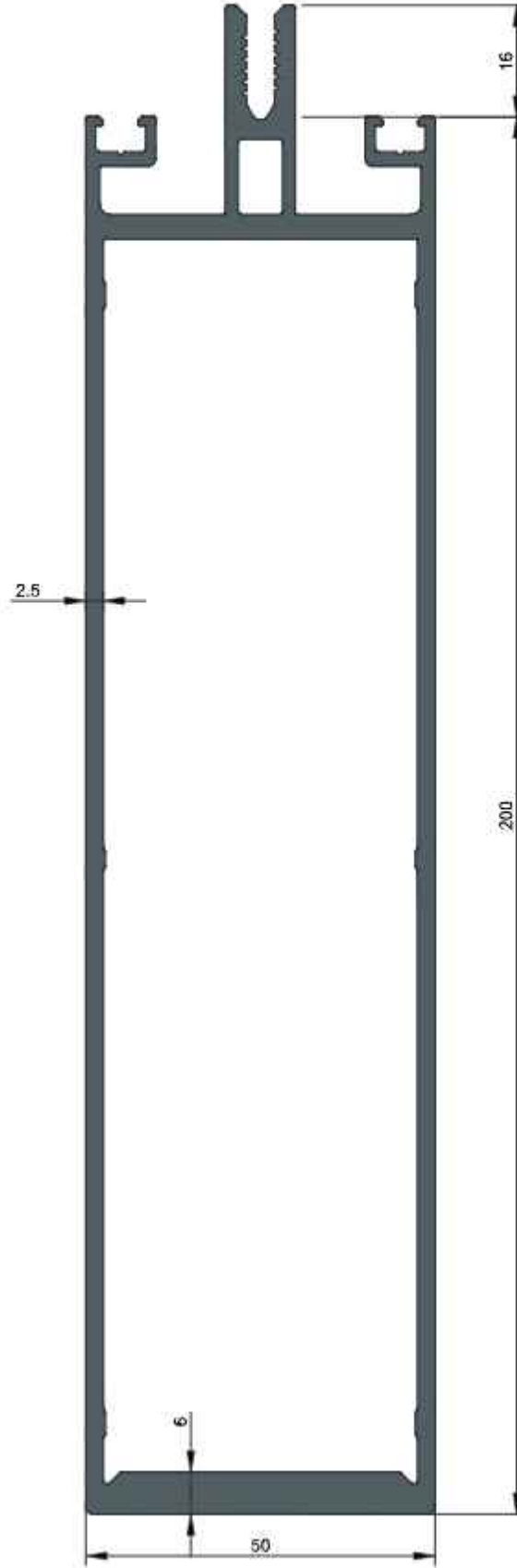

4309
Düşey Taşıyıcı Profil (200)
4,392 kg/m
Jx=891,73 cm ⁴ Jy=64,57 cm ⁴

★ Yandaki profil birim ağırlıkları, bilgisayarda hesaplanmış teorik ağırlıklardır.

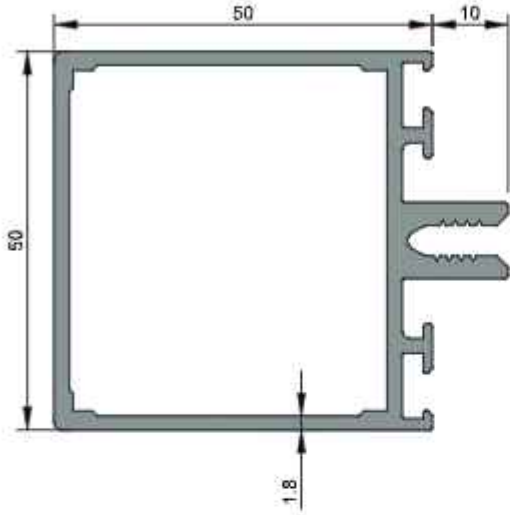

4808
Yatay Taşıyıcı Profil (50)
1,323 kg/m
$J_x=19,97 \text{ cm}^4$ $J_y=14,96 \text{ cm}^4$

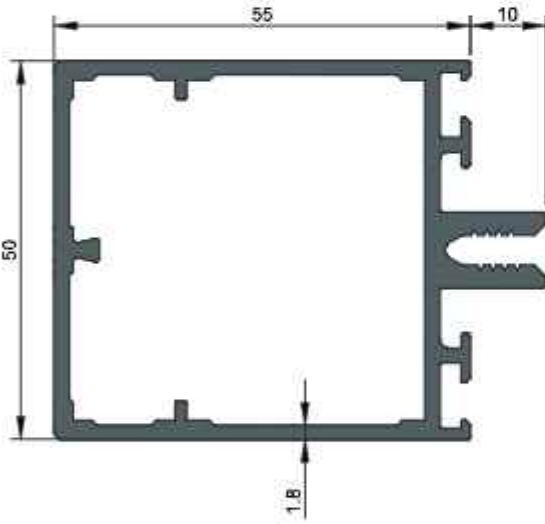

4310
Yatay Taşıyıcı Profil (55)
1,453 kg/m
$J_x=26,20 \text{ cm}^4$ $J_y=16,91 \text{ cm}^4$

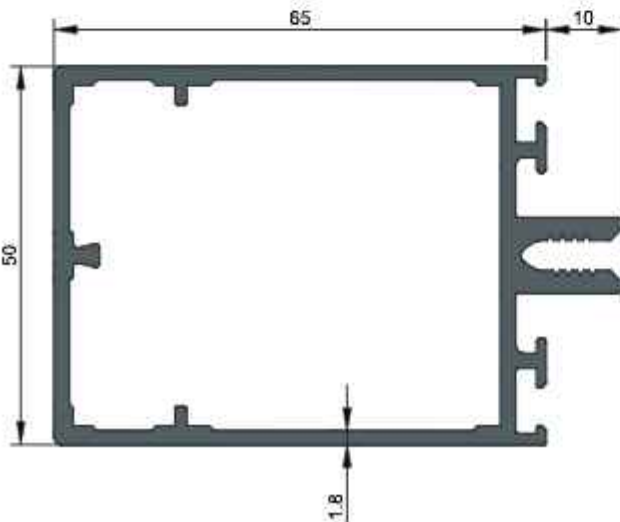

4311
Yatay Taşıyıcı Profil (65)
1,551 kg/m
$J_x=38,52 \text{ cm}^4$ $J_y=19,00 \text{ cm}^4$

★ Yandaki profil birim ağırlıkları, bilgisayarla hesaplanmış teorik ağırlıklardır.

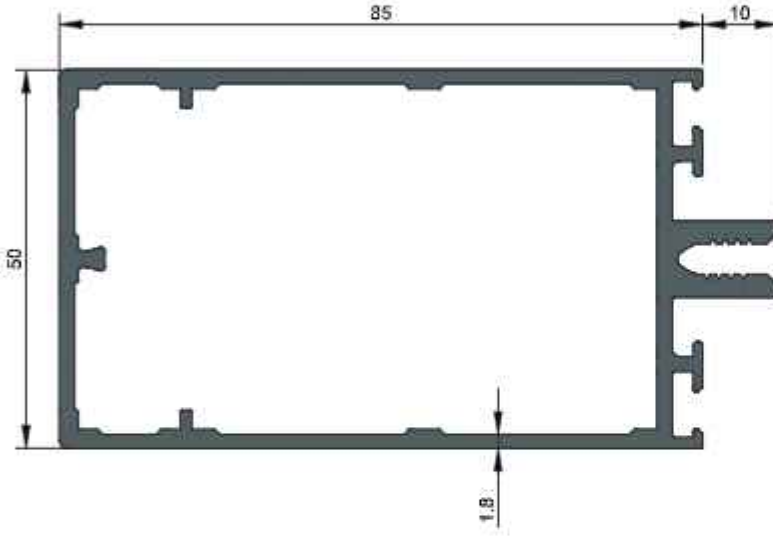

4312

Yatay Taşıyıcı Profil (85)

1,764 kg/m

$J_x=71,86 \text{ cm}^4$ $J_y=23,53 \text{ cm}^4$

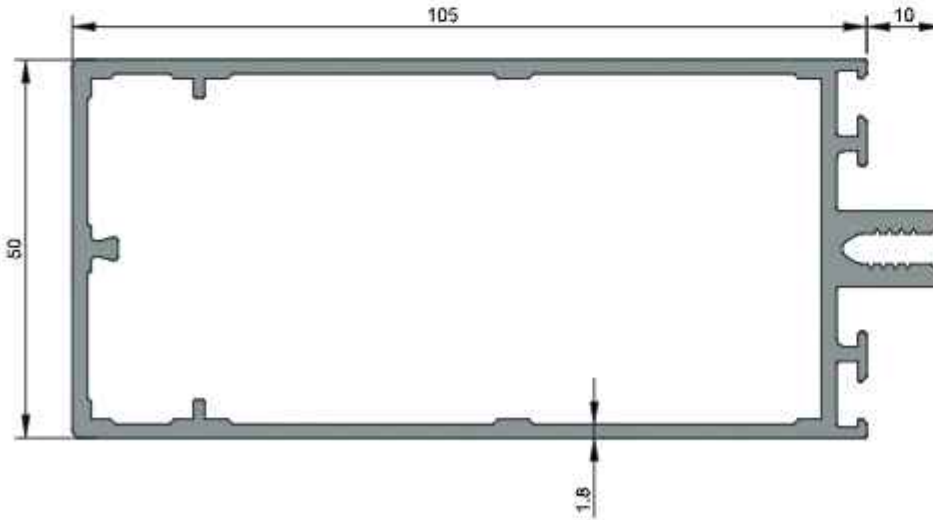

4313

Yatay Taşıyıcı Profil (105)

1,959 kg/m

$J_x=118,04 \text{ cm}^4$ $J_y=27,71 \text{ cm}^4$

4314

Yatay Taşıyıcı Profil (125)

2,154 kg/m

$J_x=178,50 \text{ cm}^4$ $J_y=31,89 \text{ cm}^4$

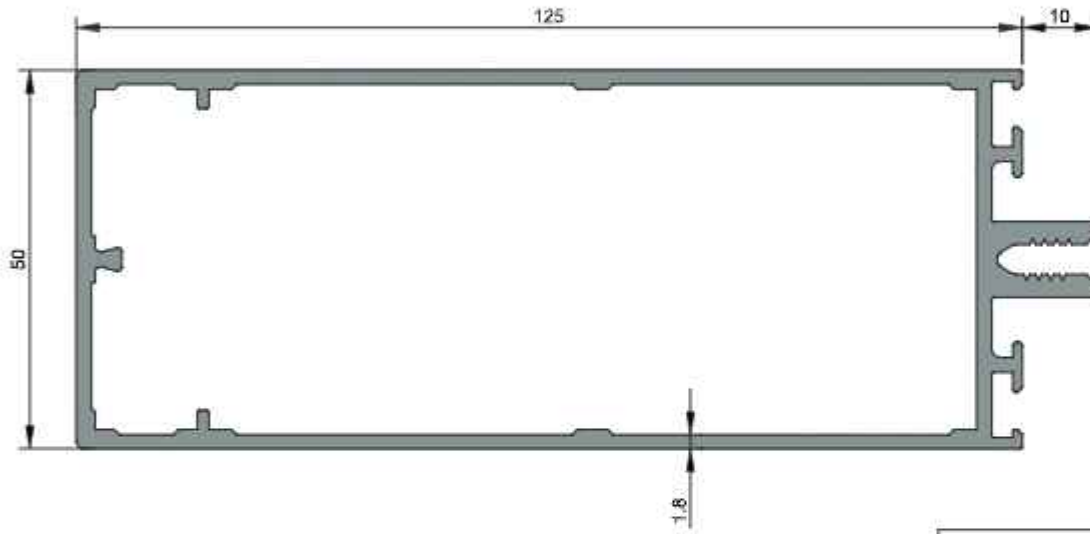

4315

Yatay Taşıyıcı Profil (145)

2,467 kg/m

$J_x=259,69 \text{ cm}^4$ $J_y=38,40 \text{ cm}^4$

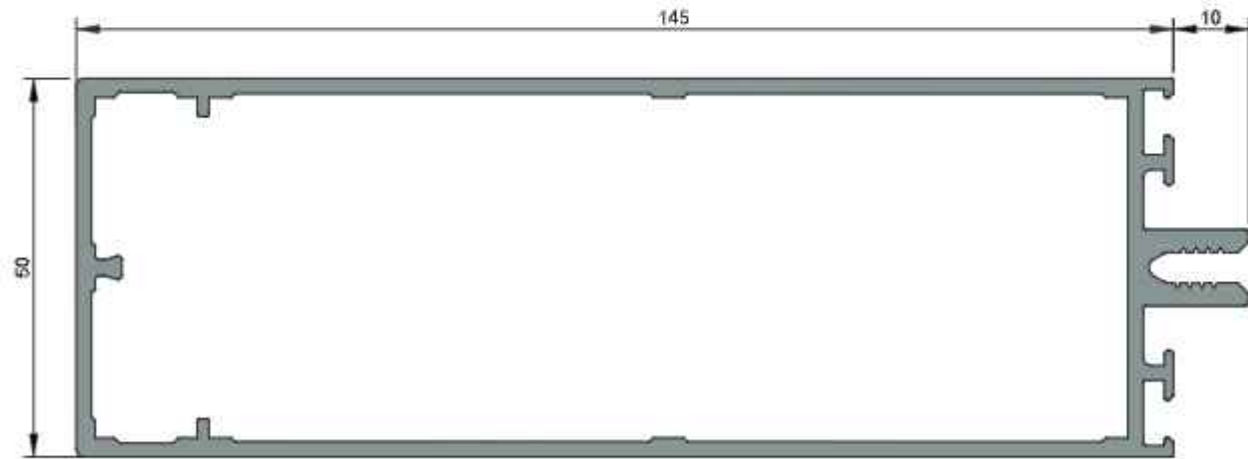

★ Yandaki profil birim ağırlıkları, bilgisayarla hesaplanmış teorik ağırlıklardır.

★ Yandaki profil birim ağırlıkları, bilgisayarla hesaplanmış teorik ağırlıklardır.

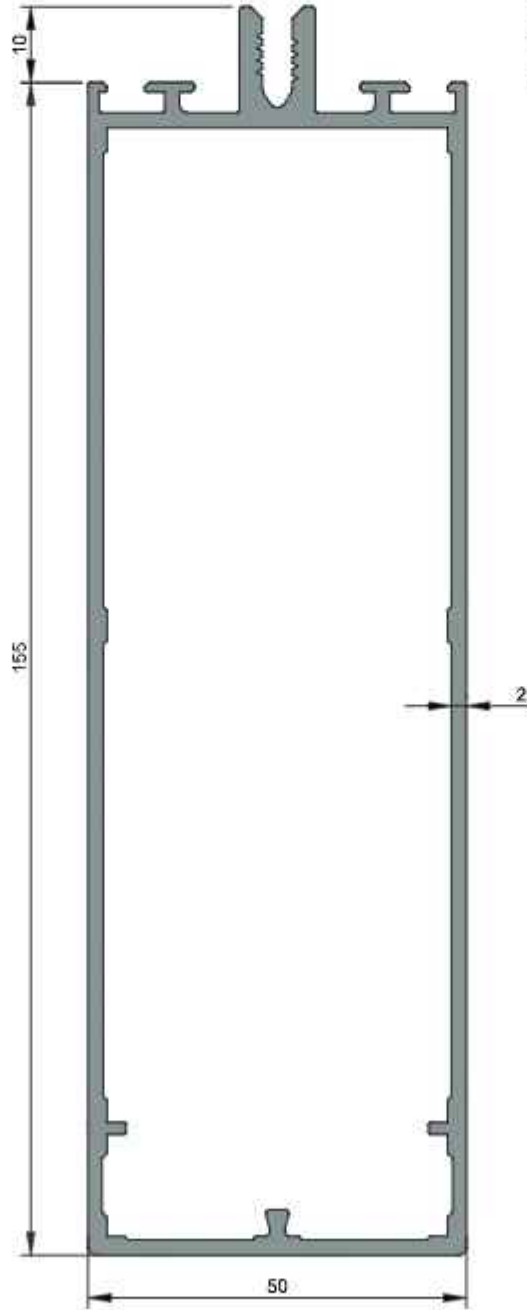

4316
Yatay Taşıyıcı Profil (155)
2,576 kg/m
$J_x=305,57 \text{ cm}^4$ $J_y=40,71 \text{ cm}^4$

4317

Yatay Taşıyıcı Profil (165)

2.851 kg/m

$J_x=371,25 \text{ cm}^4$ $J_y=46,00 \text{ cm}^4$

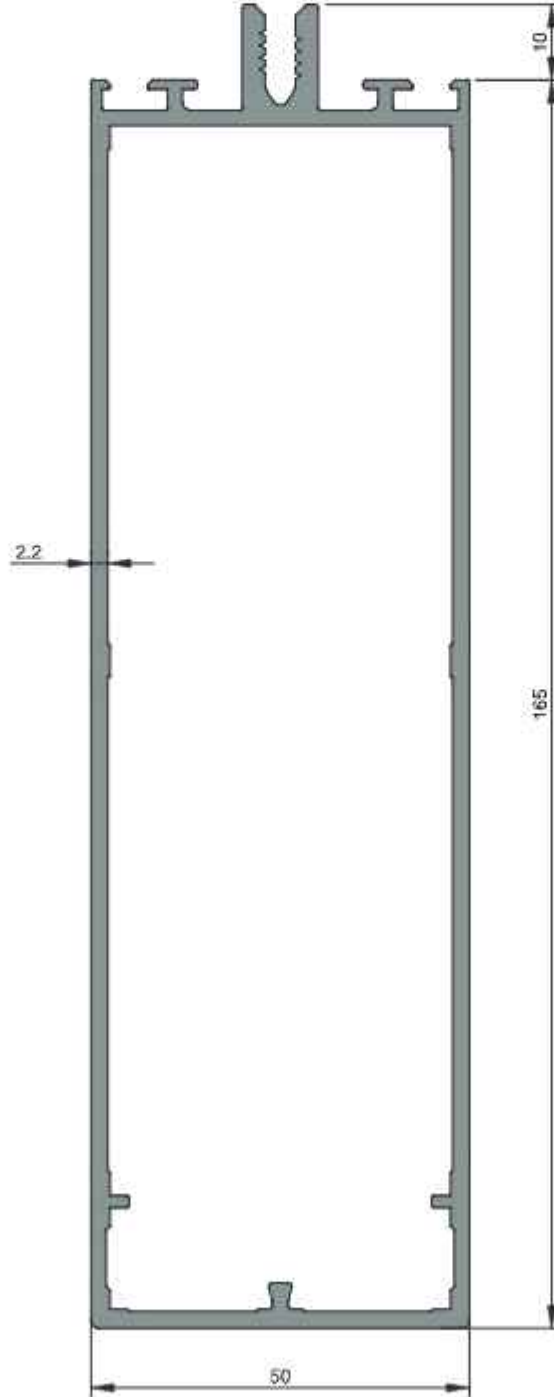

★ Yandaki profil birim ağırlıkları, bilgisayarda hesaplanmış teorik ağırlıklardır.

★ Yandaki profil birim ağırlıkları, bilgisayarda hesaplanmış teorik ağırlıklardır.

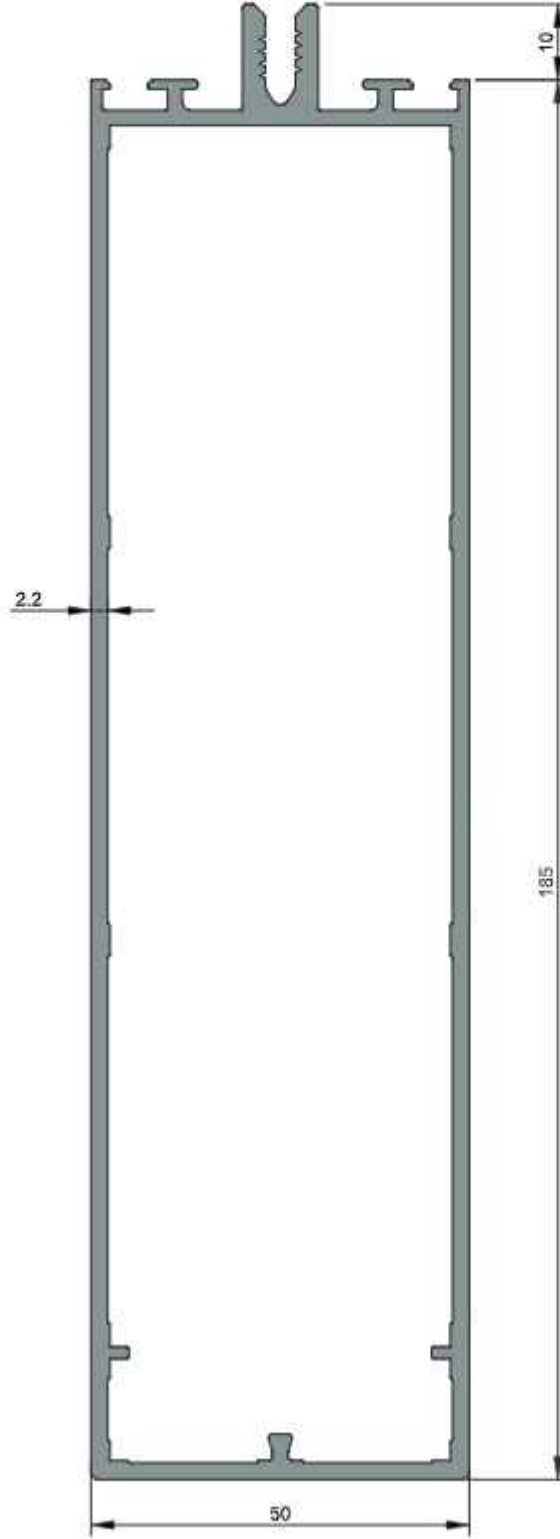

4318

Yatay Taşıyıcı Profil (185)

3,105 kg/m

$J_x=496,26 \text{ cm}^4$ $J_y=51,32 \text{ cm}^4$

★ Yandaki profil birim ağırlıkları, bilgisayararda hesaplanmış teorik ağırlıklardır.

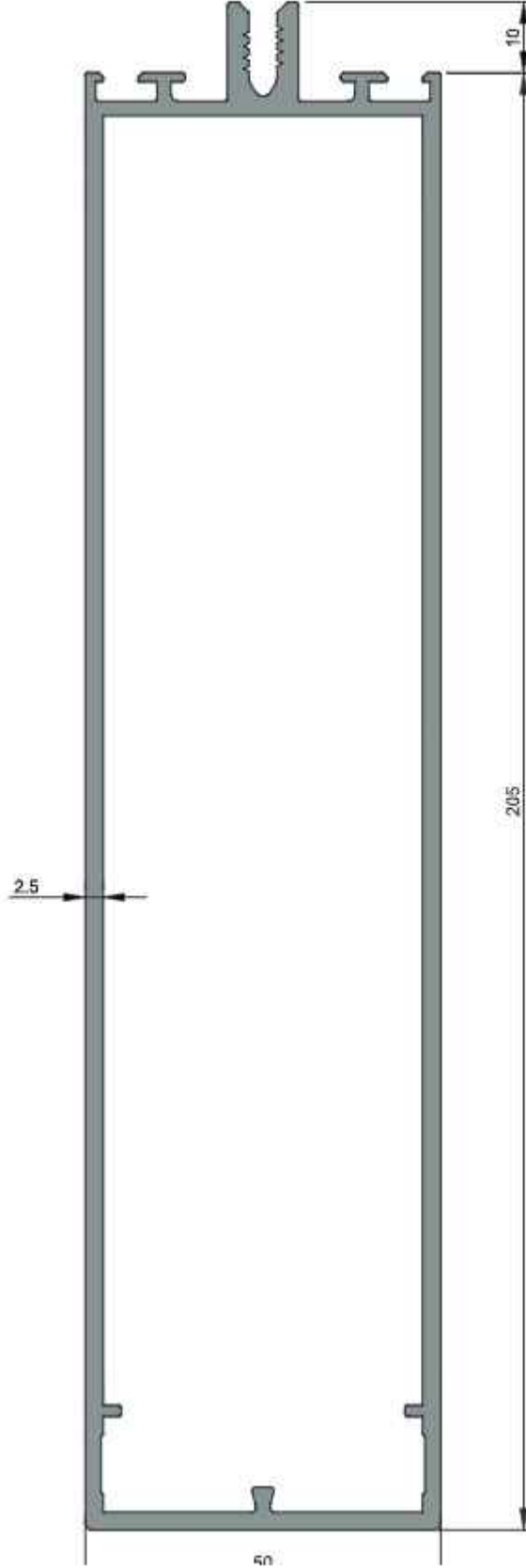

4319

Yatay Taşıyıcı Profil (205)

3,764 kg/m

$J_x=715,49 \text{ cm}^4$ $J_y=62,41 \text{ cm}^4$

★ Yandaki profil birim ağırlıkları, bilgisayarla hesaplanmış teorik ağırlıklardır.

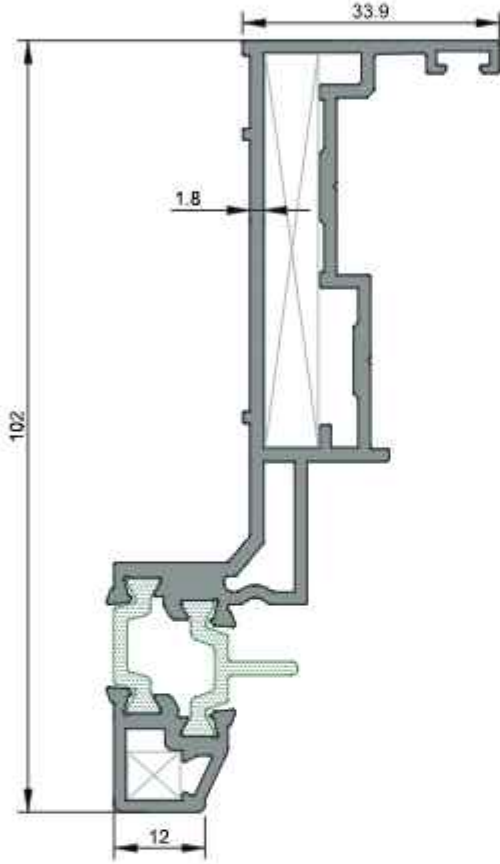

4321-4322

Gizli Kasa Profili

1,681 kg/m

Jx=72,50 cm⁴ Jy=3,58 cm⁴

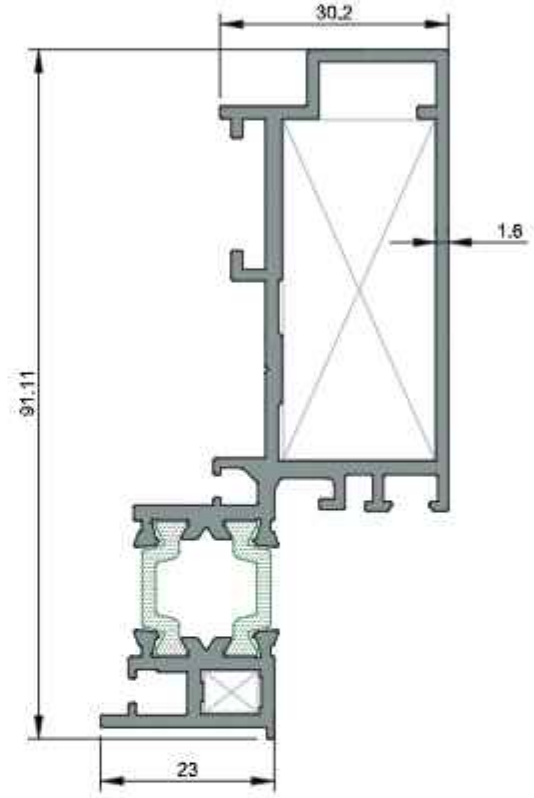

4323-4324

Gizli Kanat Profili

1,589 kg/m

Jx=50,06 cm⁴ Jy=5,98 cm⁴

★ Yandaki profil birim ağırlıkları, bilgisayararda hesaplanmış teorik ağırlıklardır.

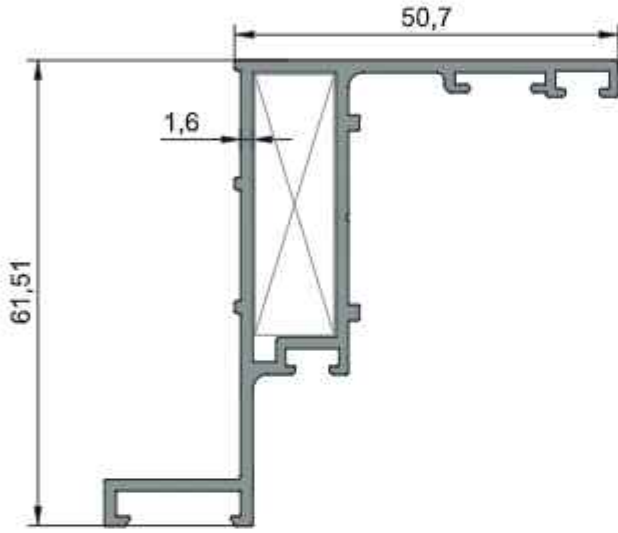

4809
Gizli Kasa Profili
0,883 kg/m
$Jx=18,67 \text{ cm}^4$ $Jy=3,01 \text{ cm}^4$

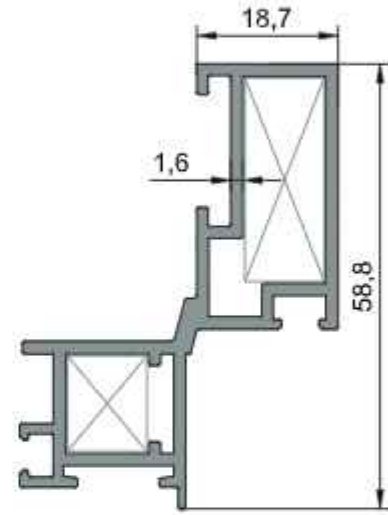

4810
Gizli Kanat Profili
0,911 kg/m
$Jx=12,73 \text{ cm}^4$ $Jy=2,04 \text{ cm}^4$

★ Yandaki profil birim ağırlıkları, bilgisayarda hesaplanmış teorik ağırlıklardır.

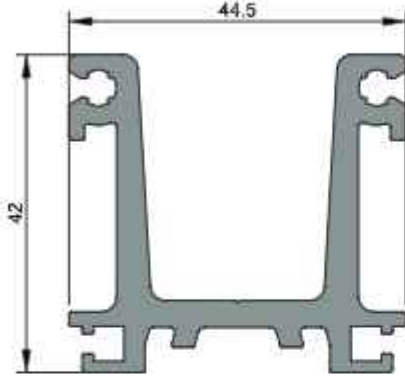

4320
Yatay Taşıyıcı Bağlantı Profili
1,419 kg/m

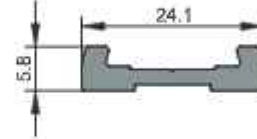

4153
Yatay Bağlantı Profili
0,218 kg/m

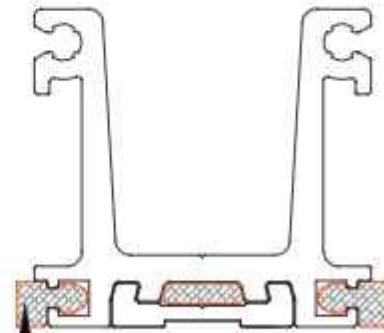
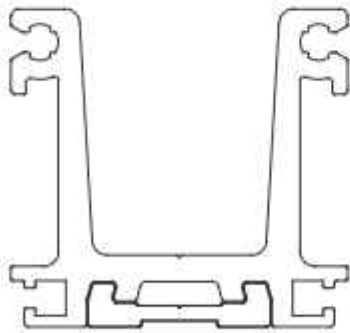

HL G 08
HL G 09
HL G 10
HL G 11
HL G 12
HL G 13
HL G 14
HL G 15

★ Yandaki profil birim ağırlıkları, bilgisayarla hesaplanmış teorik ağırlıklardır.

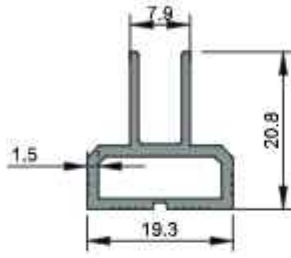

4325
Özel Cam Çıtası
0,258 kg/m

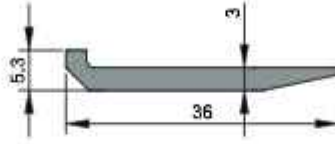

4326
Cam Destek Profili
0,269 kg/m

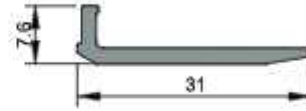

4148
Cam Taşıyıcı Profili
0,187 kg/m

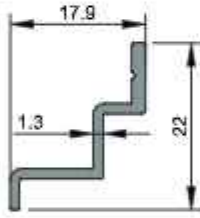

4330
Cam Taşıyıcı Profili
0,269 kg/m

NOT : 50 mm boylarda kesilerek kullanılacaktır.

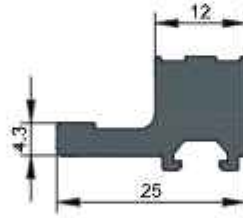

4327
Bağlantı Profili
0,538 kg/m

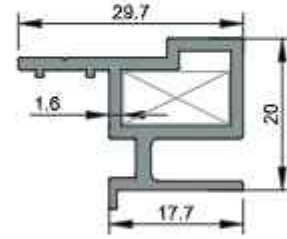

4328
Spandrel Kaset Profili
0,394 kg/m

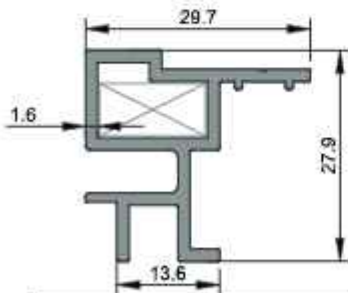

4329
Kompozit Panel Kaset Profili
0,394 kg/m

★ Yandaki profil birim ağırlıkları, bilgisayarda hesaplanmış teorik ağırlıklardır.

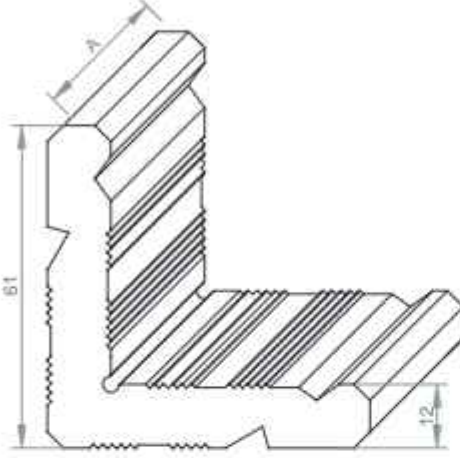

3871

Köşe Takozu

6,304 kg/m

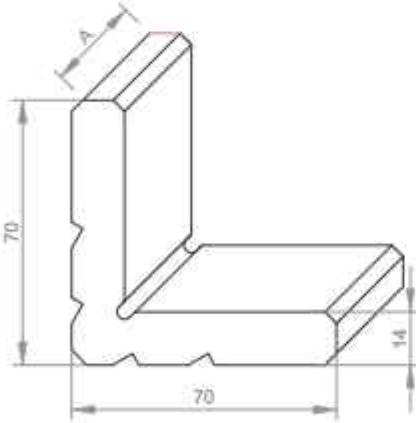

3429

Köşe Takozu

4,569 kg/m

Aksesuar Kodu	Profil Kodu	Kesim Ölçüsü A(mm)
K3429 072	4328	7.2
K3429 069	4329	6.9

★ Yandaki profil birim ağırlıkları, bilgisayarda hesaplanmış teorik ağırlıklardır.

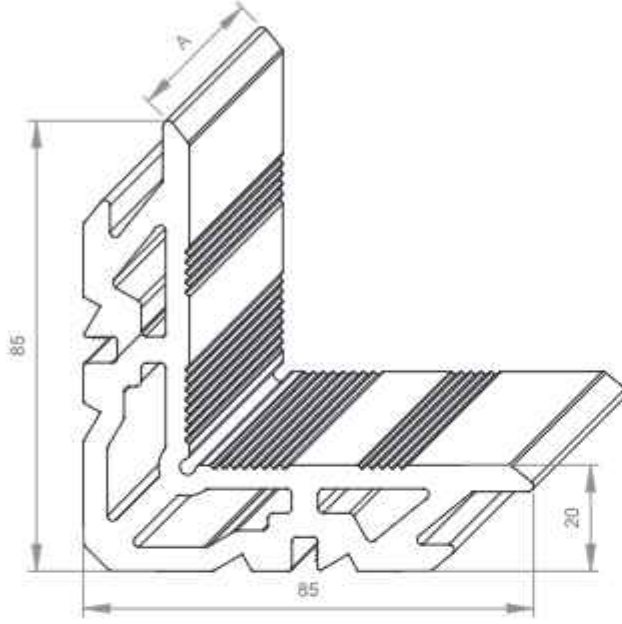

4332

Köşe Takozu

4,455 kg/m

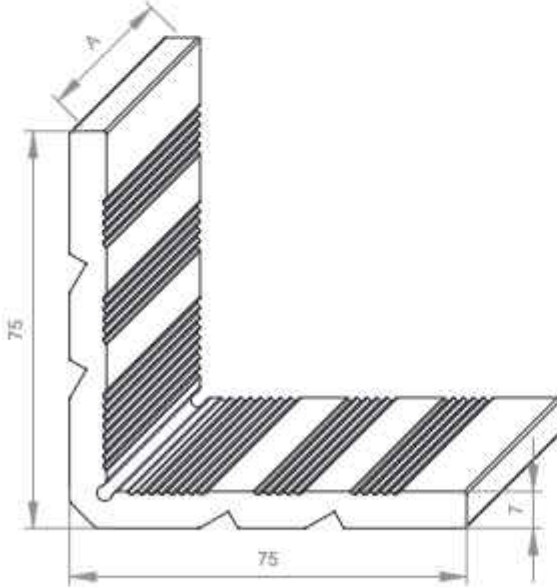

4333

Köşe Takozu

2,472 kg/m

Aksesuar Kodu	Profil Kodu	Kesim Ölçüsü A(mm)
K4333 072	4328	7.2
K4333 069	4329	6.9

★ Yandaki profil birim ağırlıkları, bilgisayarla hesaplanmış teorik ağırlıklardır.

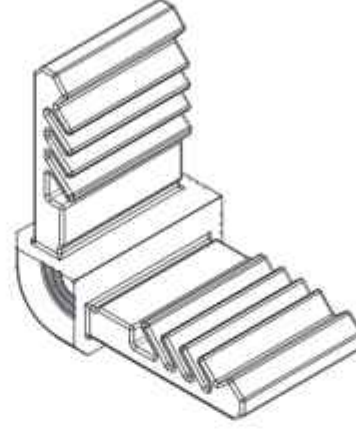
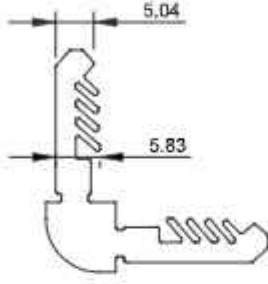

CAM ÇİTASI İMALAT DETAYI

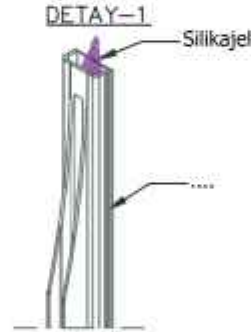

MONTAJ ÖLÇÜLERİ DETAY-2

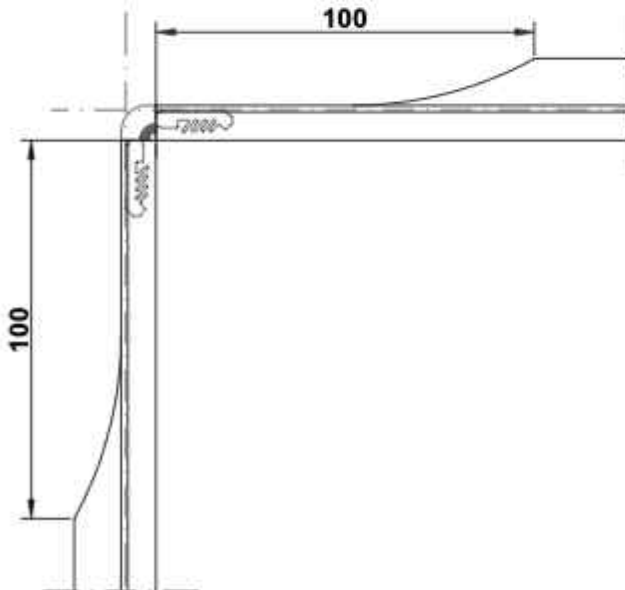

MONTAJ ŞEKLİ DETAY-3

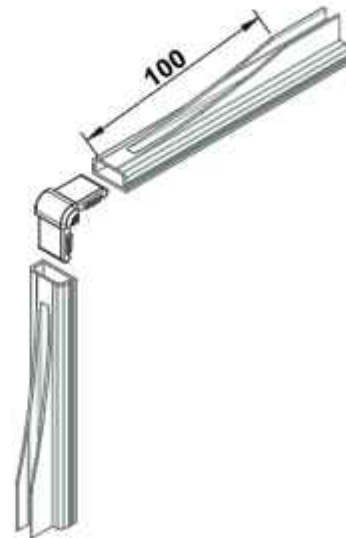

SİLİKON CEPHE BAĞLANTI PROFİLİ KESİM ÖLÇÜLERİ

* Rüzgar yükü , kanat ölçü ve ağırlığı dikkate alınarak statik hesaplama ile kullanılacak adetler belirlenmelidir.

* Kanat dış kenarlarından 150 mm mesafede ve devamında 400 mm aralıklarda kullanılmalıdır.

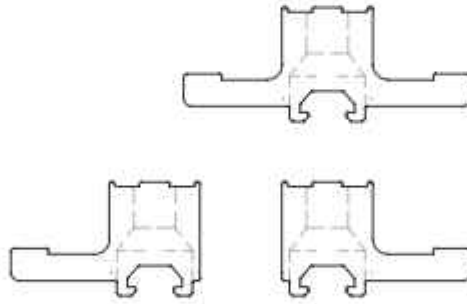

★ Yandaki profil birim ağırlıkları, bilgisayarla hesaplanmış teorik ağırlıklardır.

★ Yandaki profil birim ağırlıkları, bilgisayarda hesaplanmış teorik ağırlıklardır.

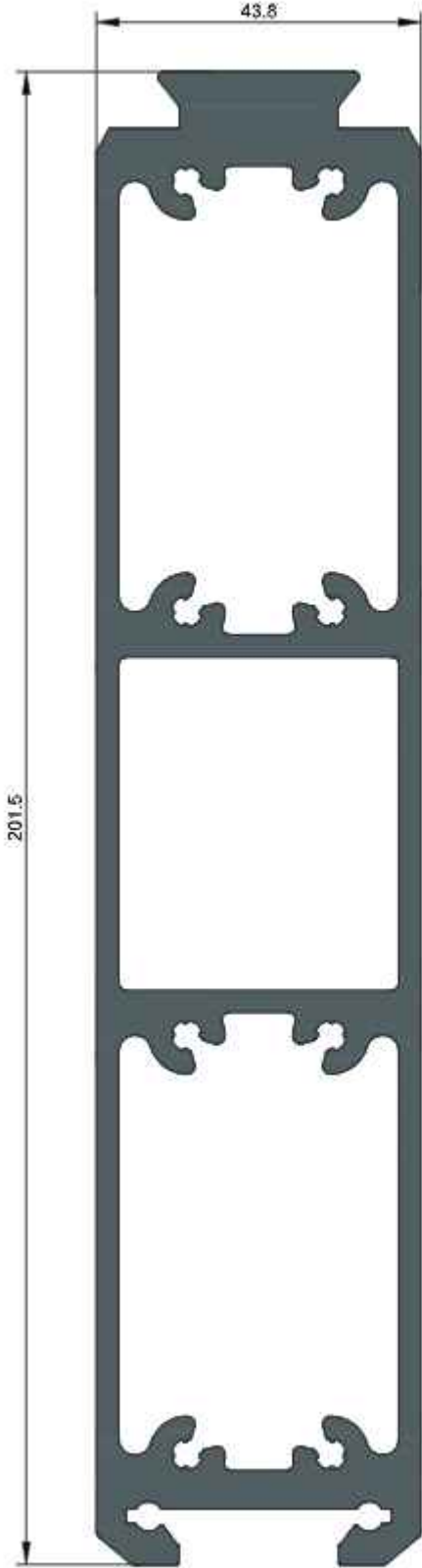

4494
Dilatasyon Profili
6,632 kg/m

Aksesuar Kodu	Profil Kodu	Kesim Ölçüsü A(mm)
D4494 415	4300	41.5
D4494 041	4301	41
D4494 605	4302	60.5
D4494 869	4303	80.5
D4494 1005	4304	100.5
D4494 1195	4305	119.5
D4494 1285	4306	128.5
D4494 138	4307	138
D4494 1575	4308	157.5
D4494 176	4309	176

★ Yandaki profil birim ağırlıkları, bilgisayarla hesaplanmış teorik ağırlıklardır.

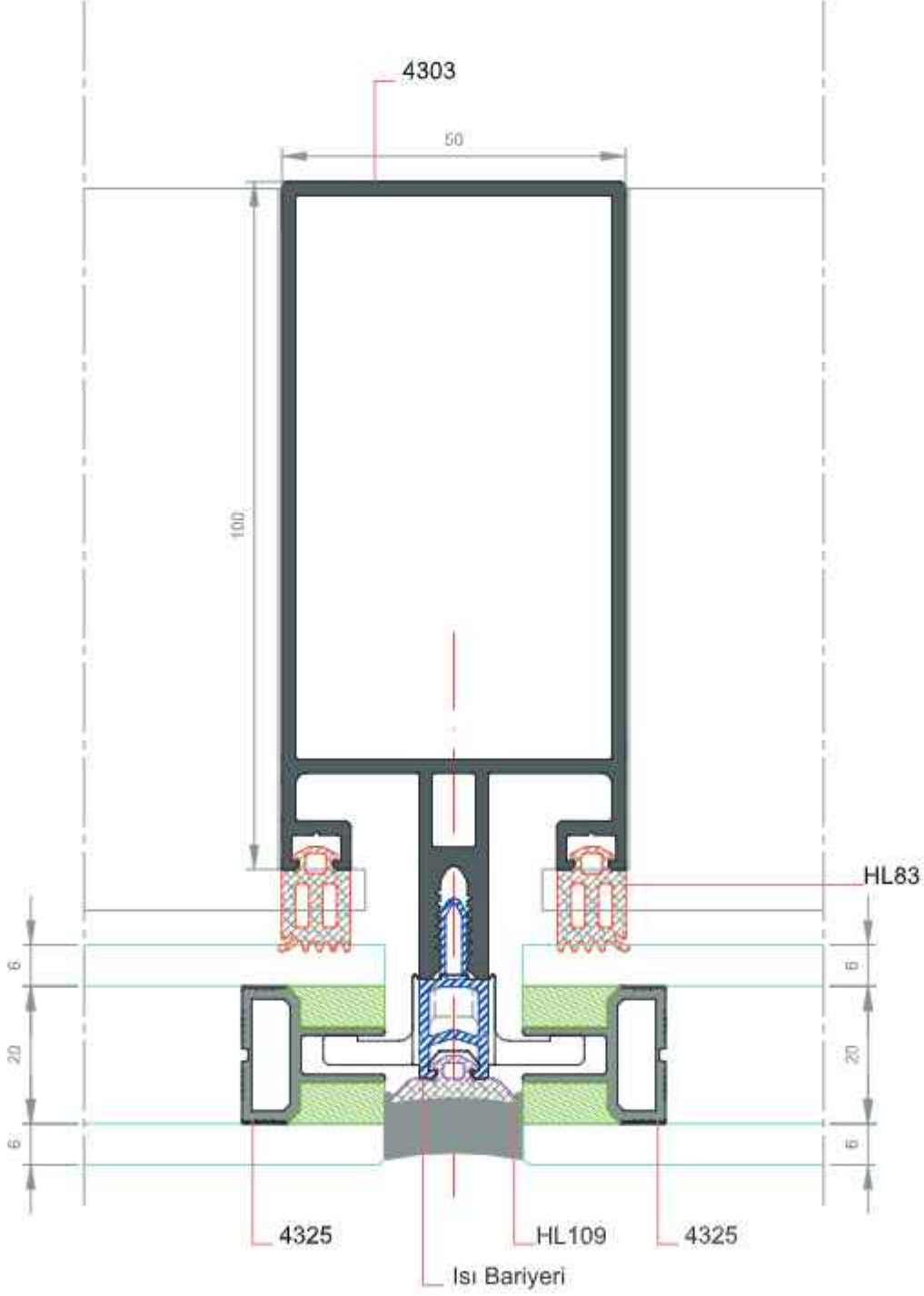

★ Yandaki profil birim ağırlıkları, bilgisayarla hesaplanmış teorik ağırlıklardır.

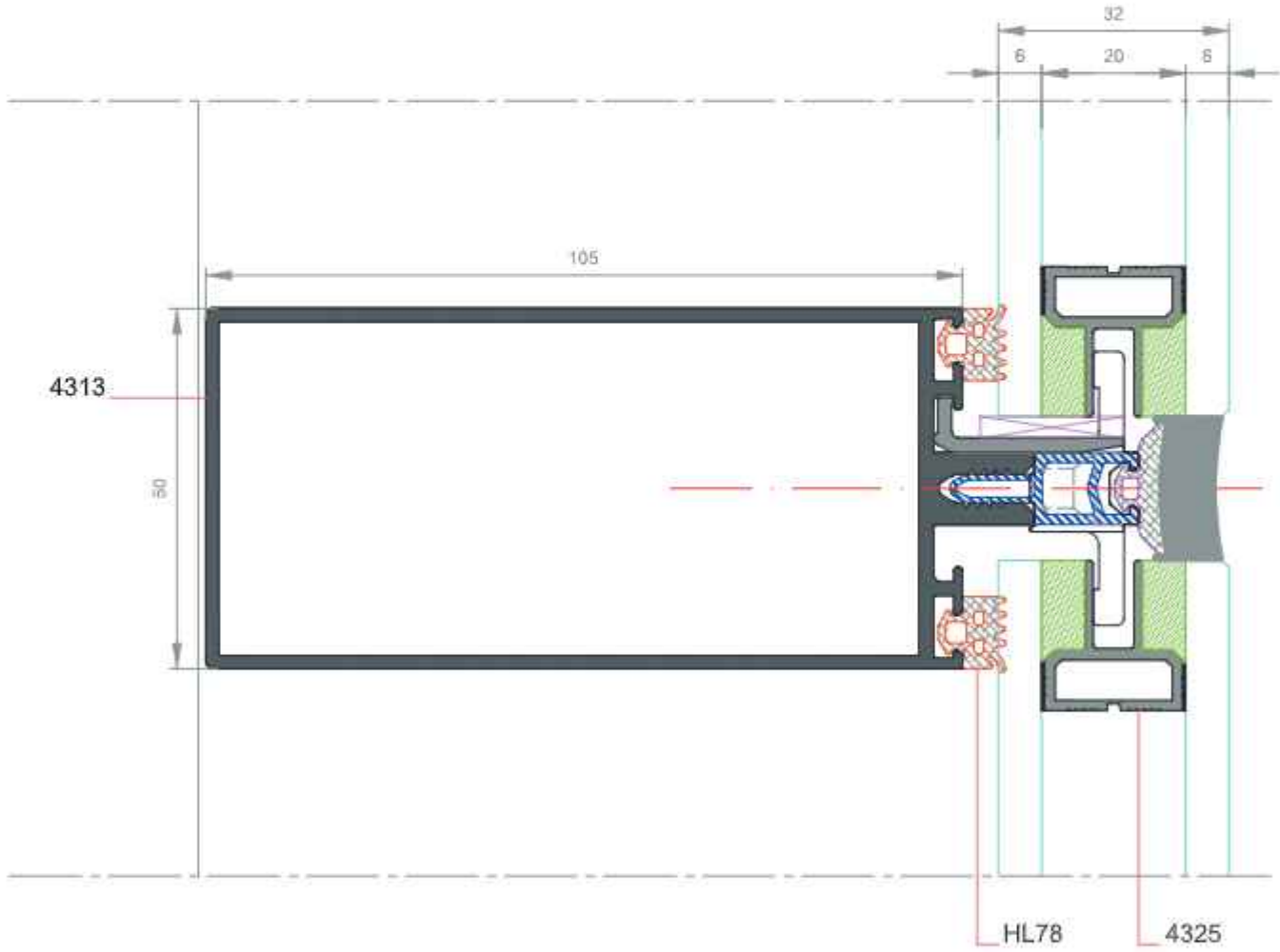

★ Yandaki profil birim ağırlıkları, bilgisayarla hesaplanmış teorik ağırlıklardır.

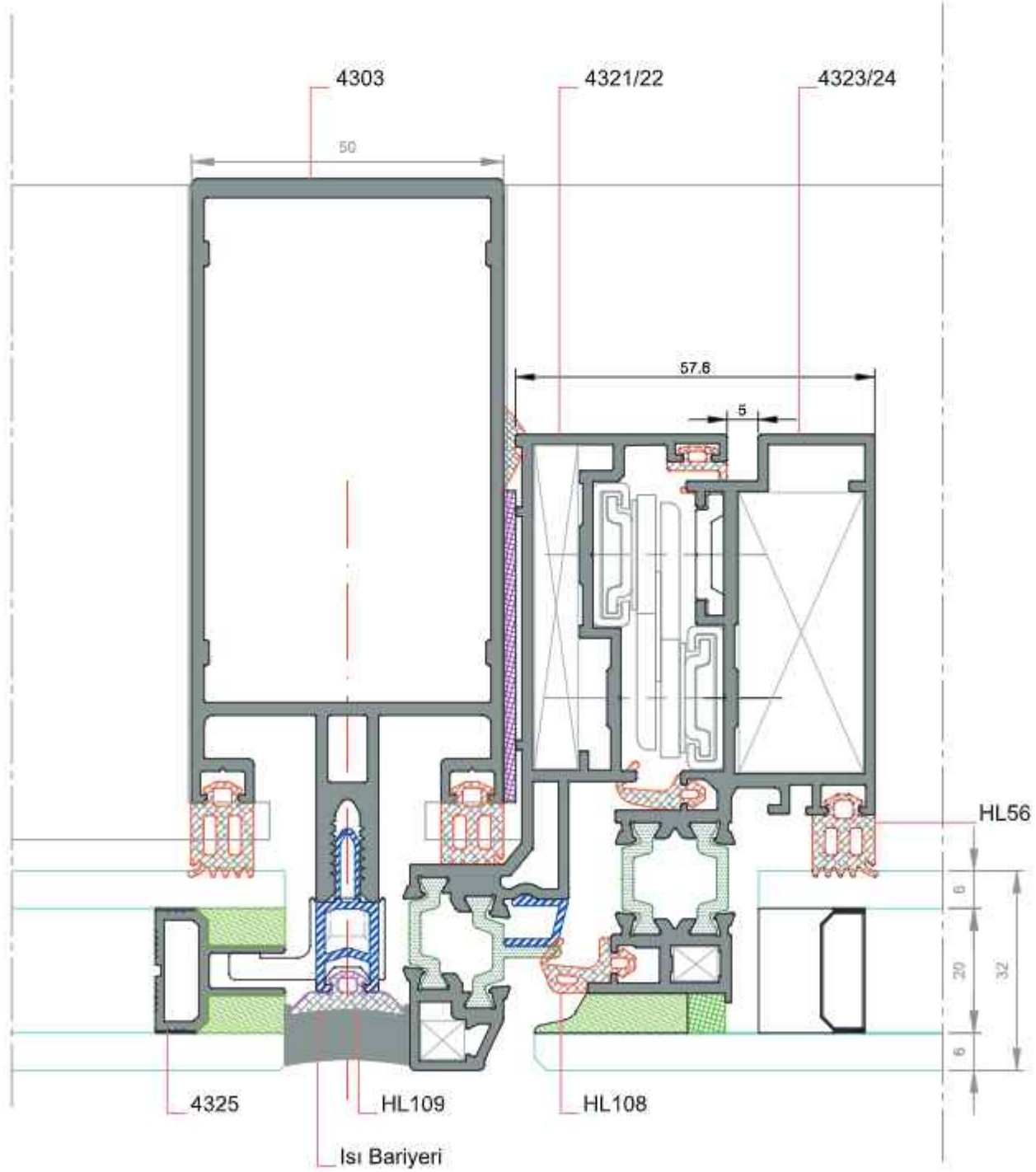

★ Yandaki profil birim ağırlıkları, bilgisayarda hesaplanmış teorik ağırlıklardır.

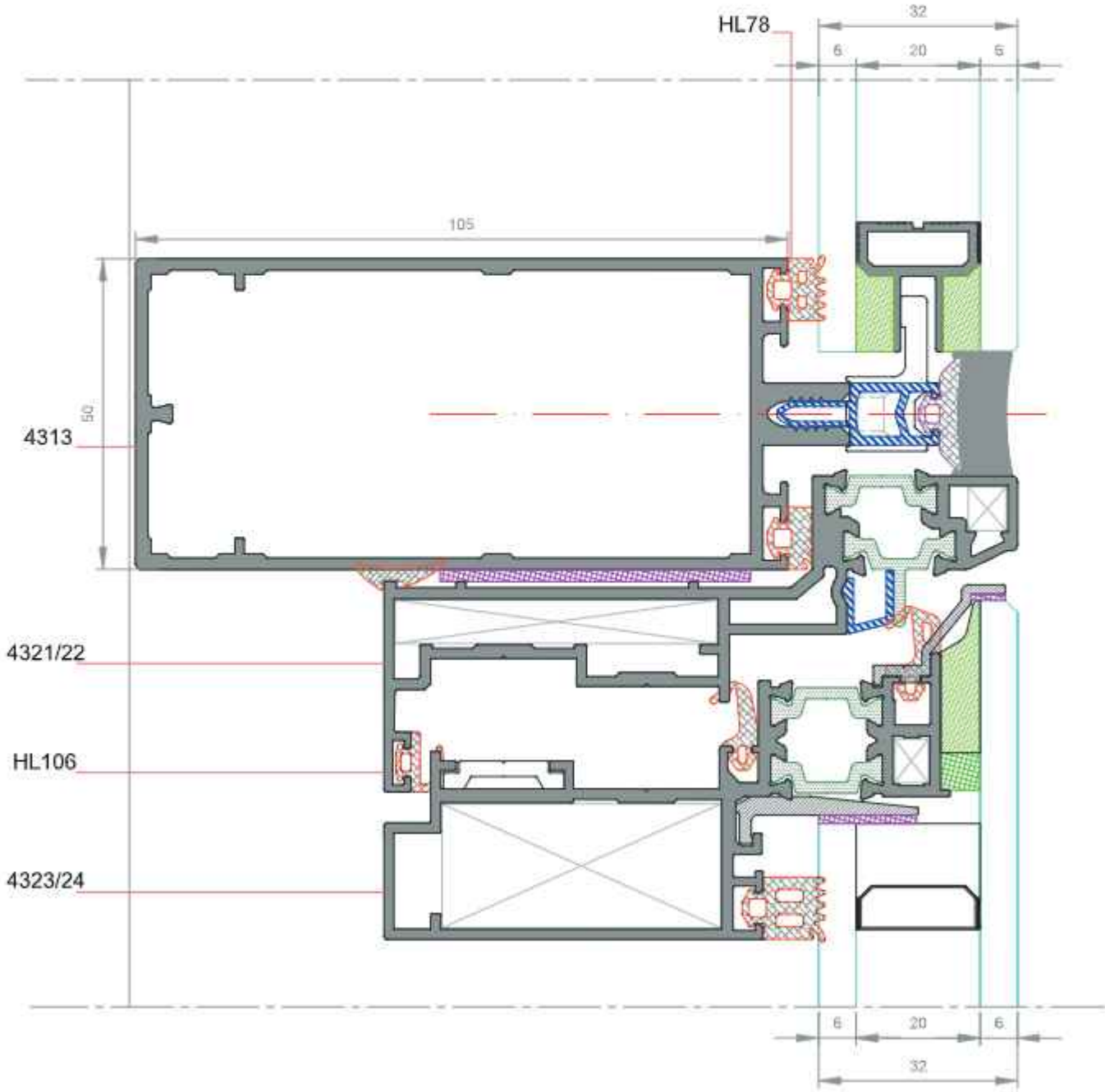

★ Yandaki profil birim ağırlıkları, bilgisayarda hesaplanmış teorik ağırlıklardır.

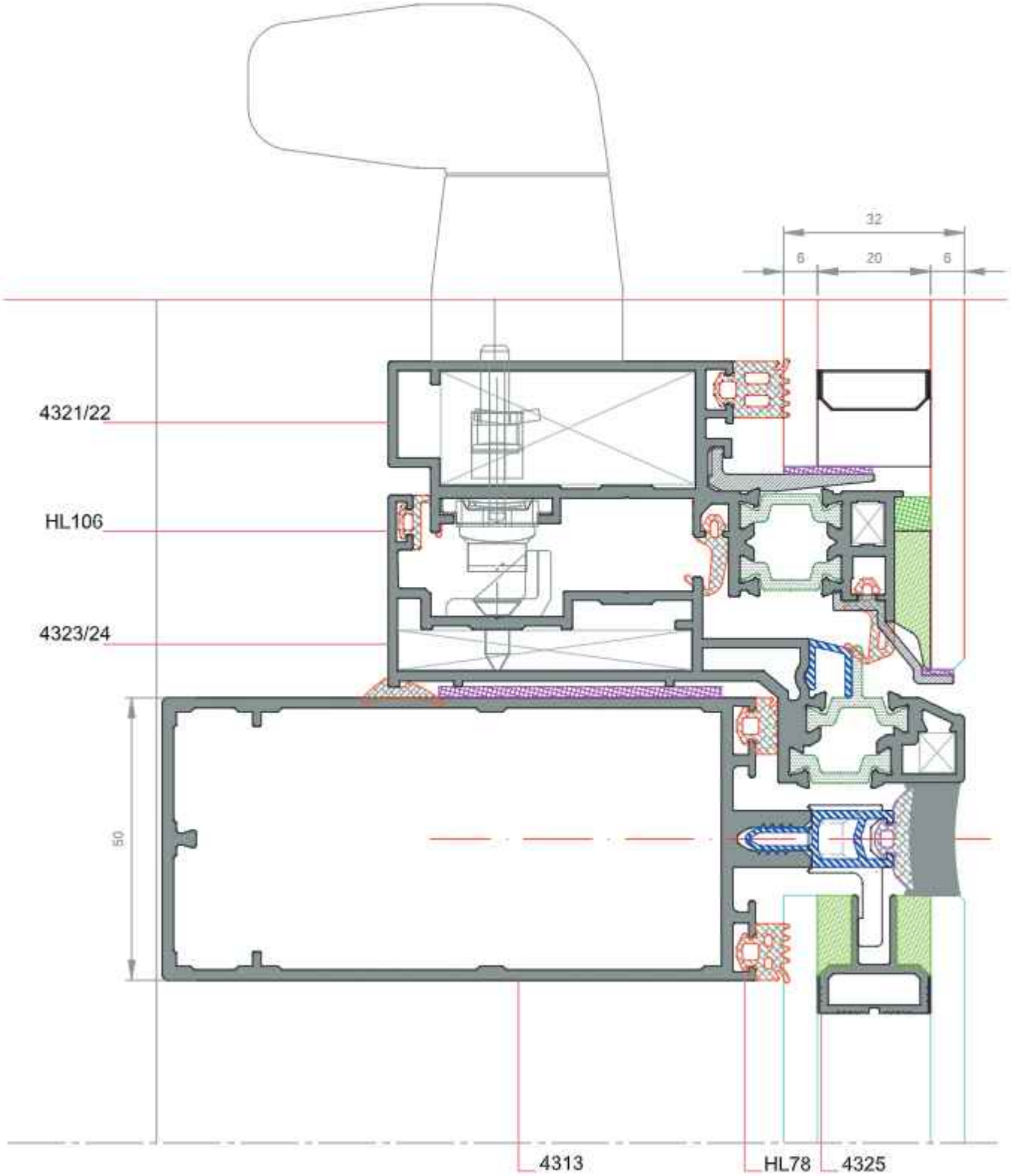

★ Yandaki profil birim ağırlıkları, bilgisayarla hesaplanmış teorik ağırlıklardır.

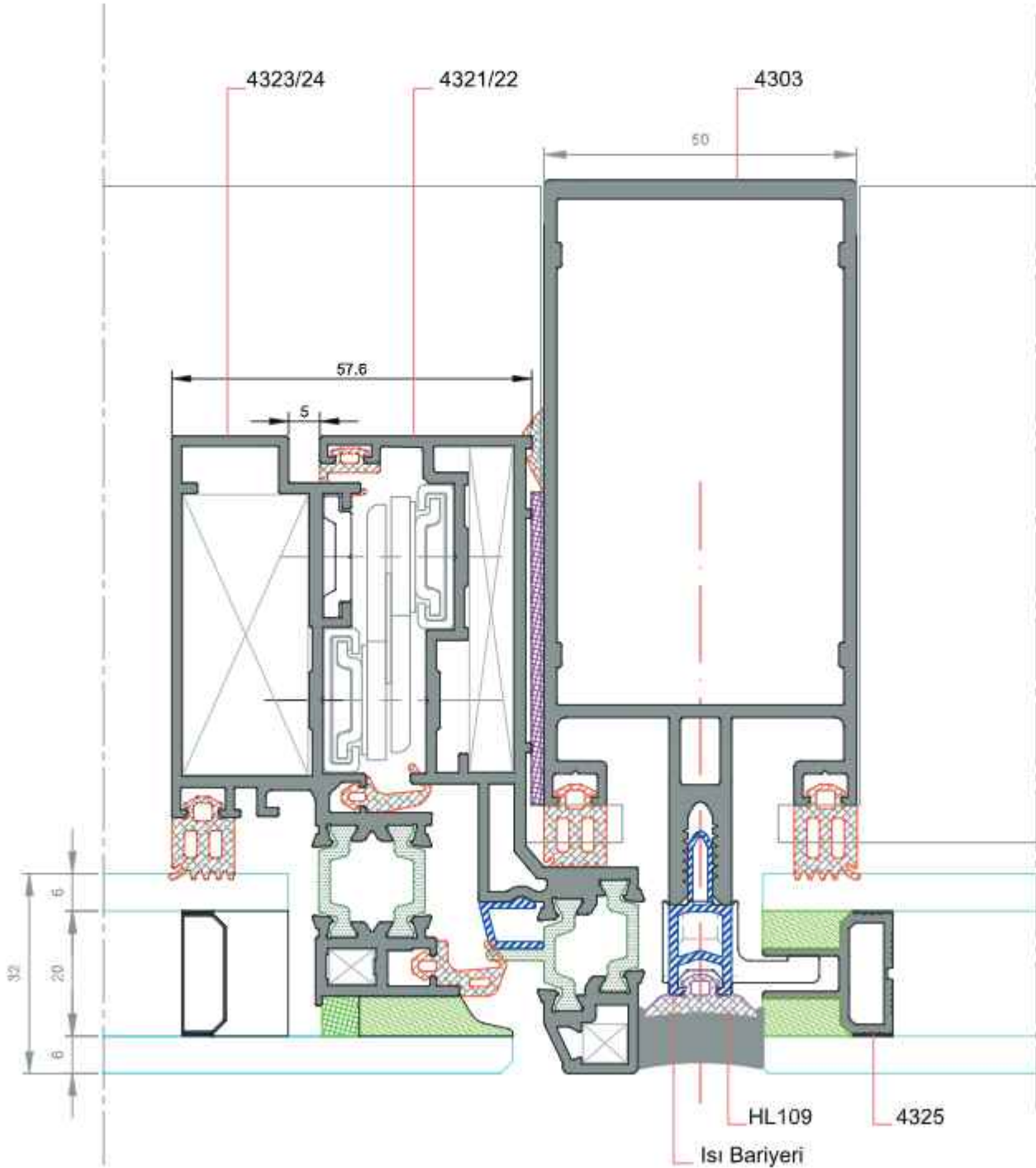

★ Yandaki profil birim ağırlıkları, bilgisayarda hesaplanmış teorik ağırlıklardır.

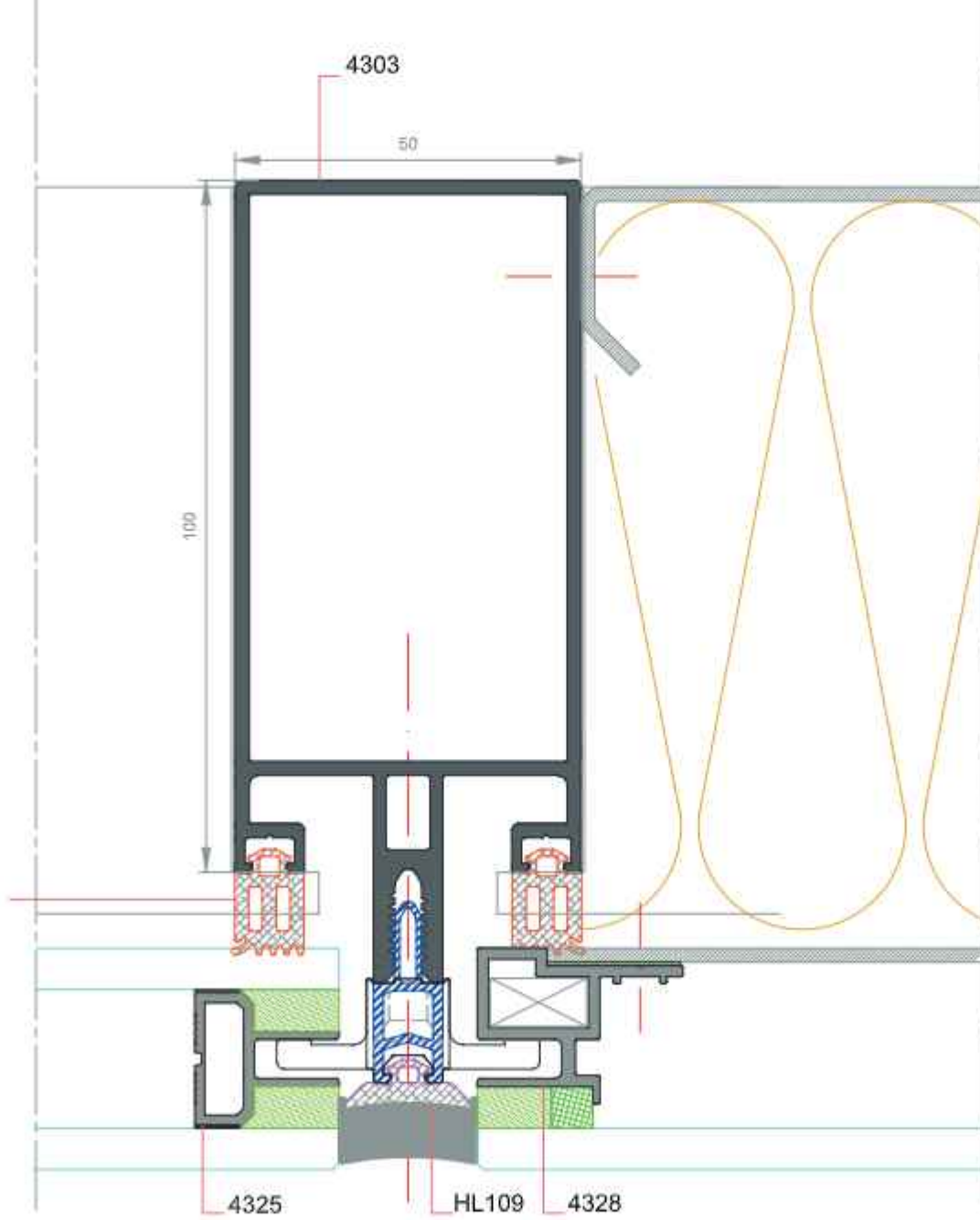

★ Yandaki profil birim ağırlıkları, bilgisayarda hesaplanmış teorik ağırlıklardır.

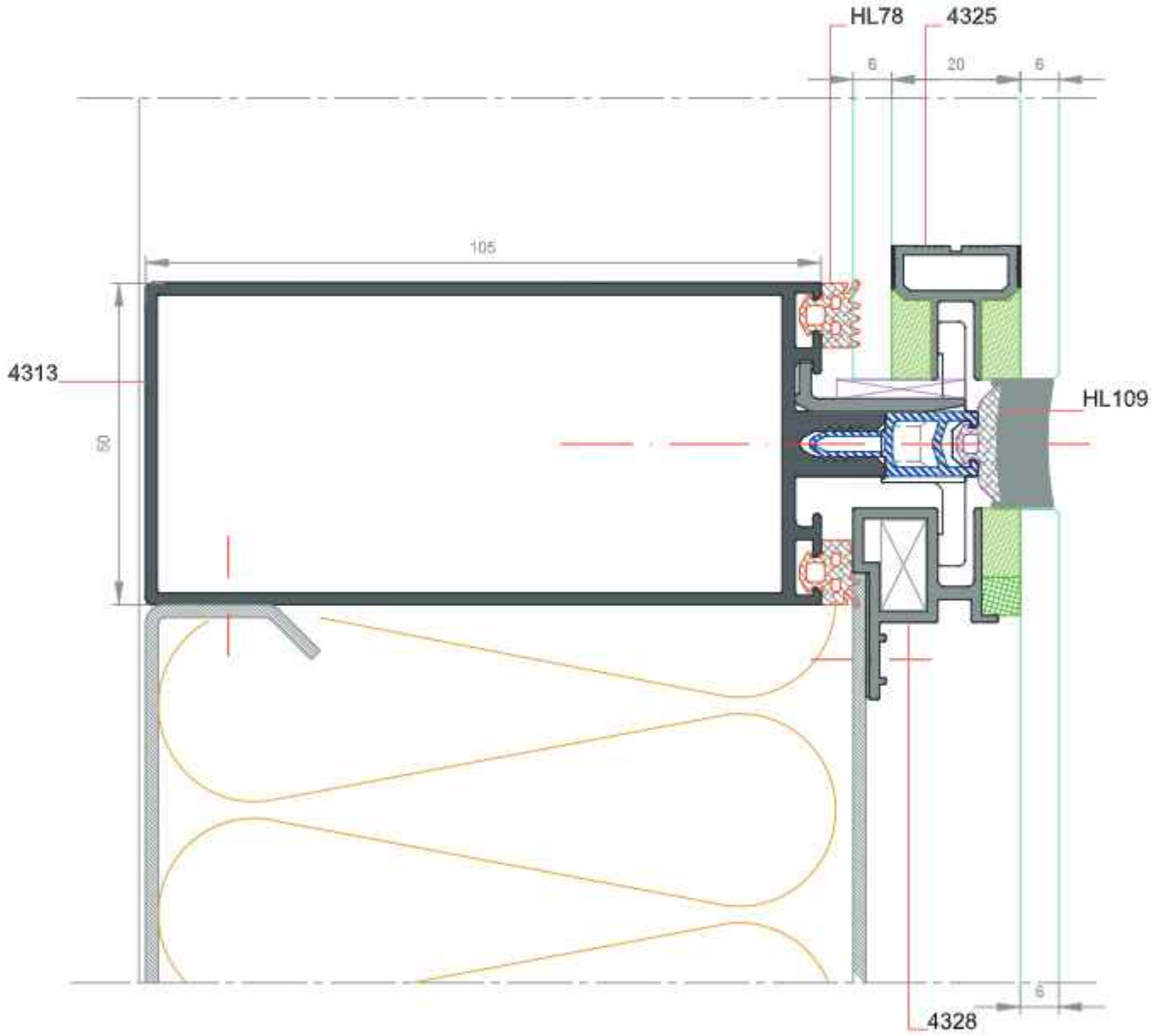

★ Yandaki profil birim ağırlıkları, bilgisayarda hesaplanmış teorik ağırlıklardır.

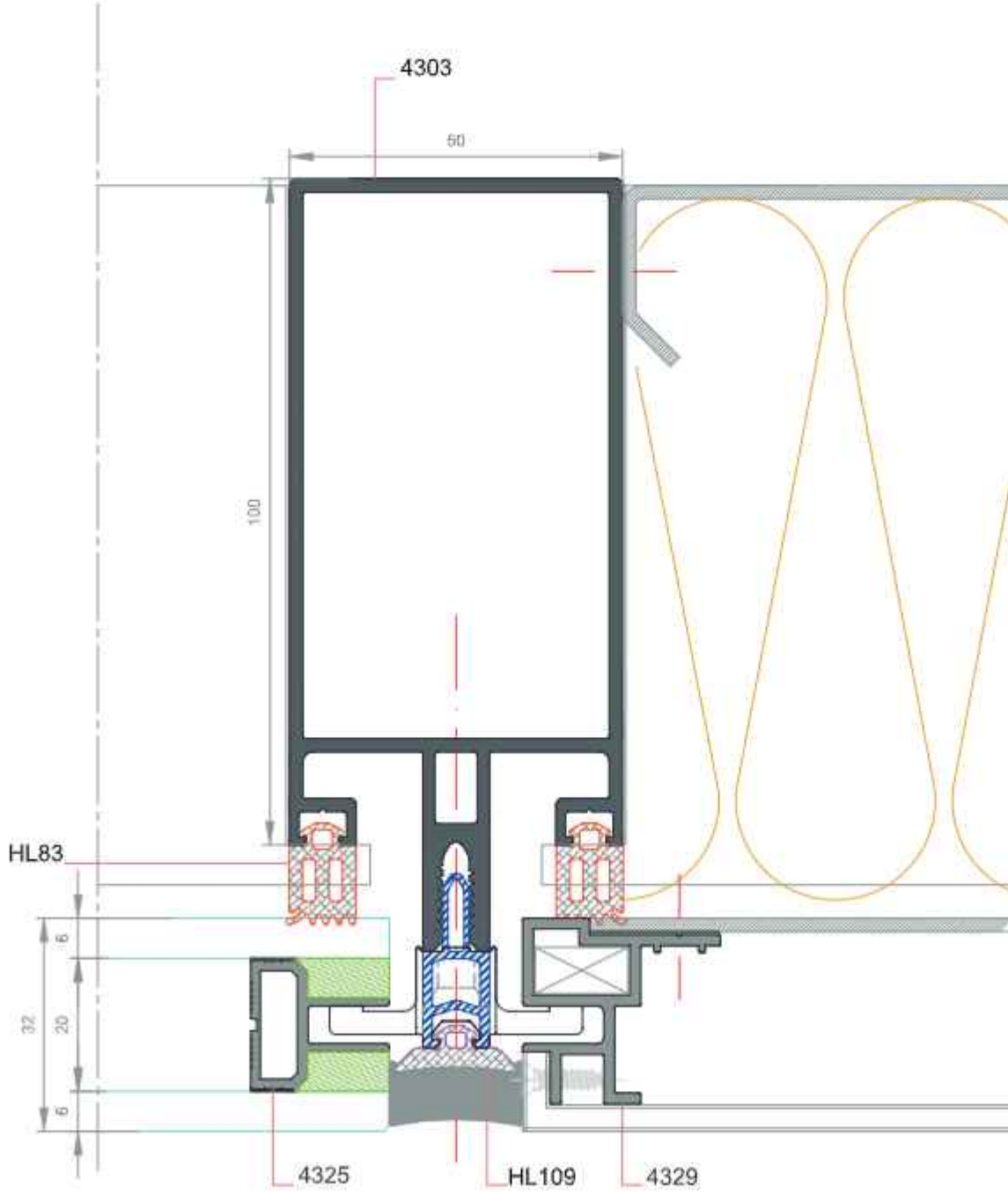

★ Yandaki profil birim ağırlıkları, bilgisayarla hesaplanmış teorik ağırlıklardır.

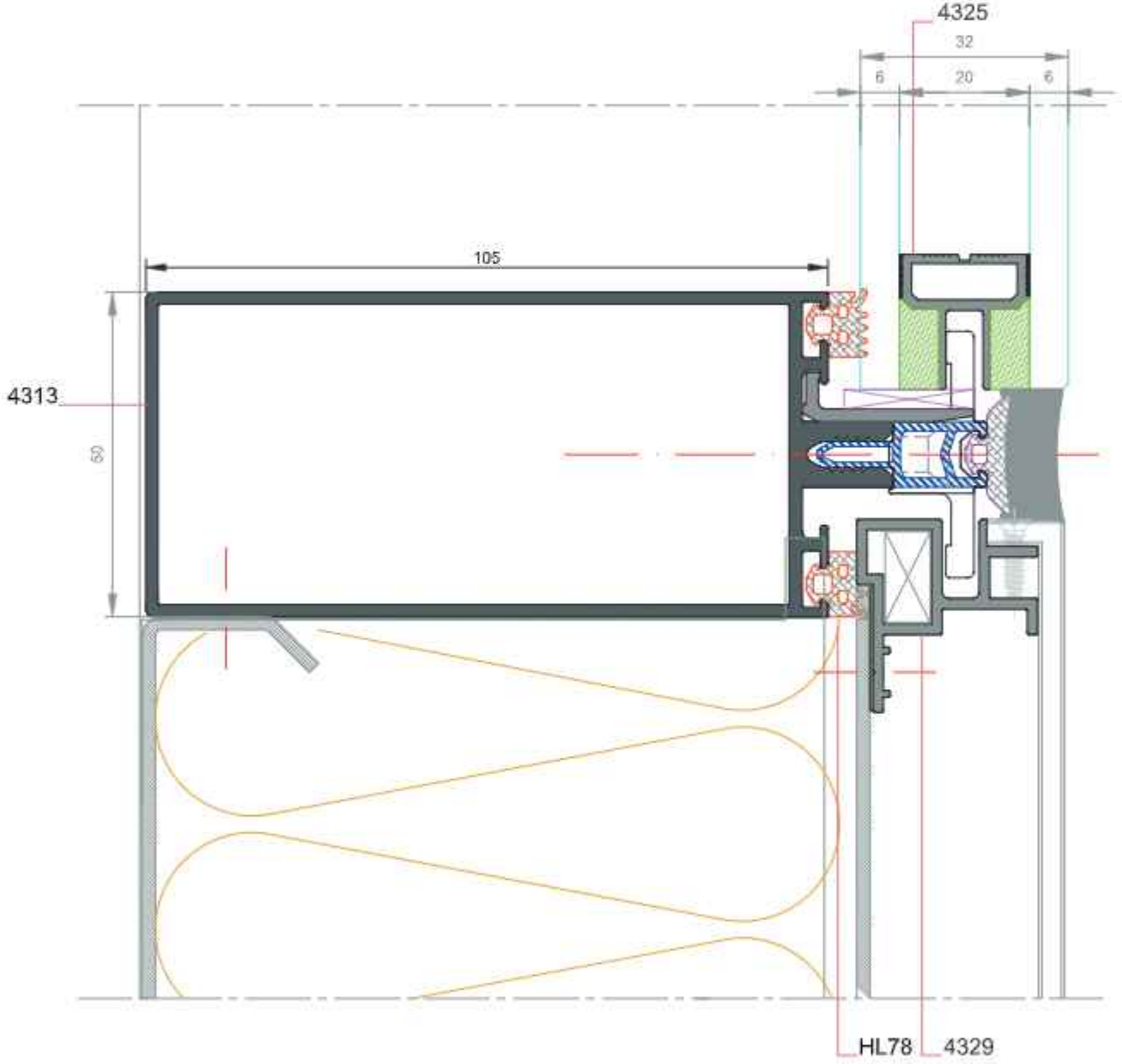



PROFİL KATALOĐU











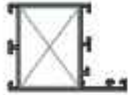

GXY H45 ISI YALITIMSIZ KAPI VE PENCERE SİSTEMİ

*GXY H45 THERMAL UNINSULATED DOOR &
WINDOW SYSTEMS*

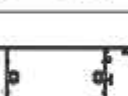

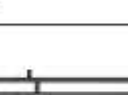

* Profil Ağırlıkları Teorik Olup Teslim Anındaki Ağırlık Geçerlidir

* *Weight of profiles are theoretical, net weight will valid at the time of delivery.*







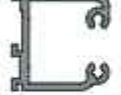

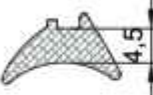
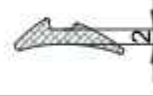

★ Yandaki profil birim ağırlıkları, bilgisayarda hesaplanmış teorik ağırlıklardır.

PROFİL KESİTİ	PROFİL KODU	PROFİL ADI	AĞIRLIK	ATALET MOMENTLERİ		SAYFA NO
				J_x (cm ⁴)	J_y (cm ⁴)	
	2381	Kasa Profili	0,815 kg/m	11,60	7,05	
	2382	Orta Kayıt Profili	0,939 kg/m	14,65	10,07	
	2958	Dar Orta Kayıt Profili	0,824 kg/m	7,98	6,71	
	2959	Kanat Profili	0,908 kg/m	16,08	3,93	
	2383	Kapı Kanat Profili	1,018 kg/m	22,51	8,69	
	2976	İçe Açılır Çift Kanat Adaptörü	0,801 kg/m	8,57	5,48	
	2960	Etek Profili	1,534 kg/m	72,60	17,76	
	2259	60'luk Pervaz Profili	0,486 kg/m	11,88	3,02	
	2260	100'lük Pervaz Profili	0,625 kg/m	34,55	4,26	
	2385	Ek Bağlantı Profili	1,116 kg/m	45,1	0,84	
	2508	Cam Çıtası	0,233 kg/m	
	2507	Cam Çıtası	0,315 kg/m	
	2384	Cam Çıtası	0,326 kg/m	
	1210	İspanyolet Çubuğu	0,112 kg/m	

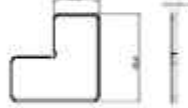

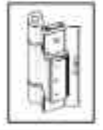

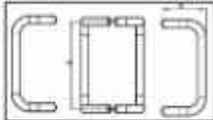





★ Yandaki profil birim ağırlıkları, bilgisayarda hesaplanmış teorik ağırlıklardır.

PROFİL KESİTİ	PROFİL KODU	PROFİL ADI	AĞIRLIK	ATALET MOMENTLERİ		SAYFA NO
				J _x (cm ⁴)	J _y (cm ⁴)	
	2181	Damlalık Profili	0,168 kg/m	
	1333	Köşe Takoza	0,773 kg/m	
	1948	Köşe Takoza	1,240 kg/m	
	2491	Köşe Takoza	3,230 kg/m	
	2386	Orta Kayıt Bağlantı Profili	0,989 kg/m	

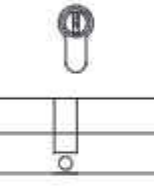
★ Yandaki profil birim ağırlıkları, bilgisayarda hesaplanmış teorik ağırlıklardır.

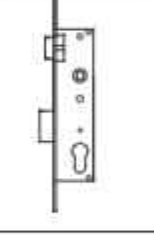
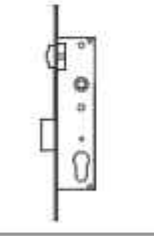
AKSESUAR KESİTİ	AKSESUAR KODU	AKSESUAR ADI	AĞIRLIK	PAKETLEME	SAYFA NO
	HL04	İç Cam Fitili - 3 mm	60 gr/m	15 kg/ 250 m	
	HL07	İç Cam Fitili - 4 mm	63 gr/m	15 kg/ 238 m	
	HL02	İç Cam Fitili - 4.5 mm	85 gr/m	15 kg/ 175 m	
	HL31	İç Cam Fitili - 2 mm	39 gr/m	15 kg/ 375 m	
	HL100	Dış Cam Fitili	48 gr/m	15 kg/ 312 m	
	HL74	Bini Fitili	37 gr/m	15 kg/ 405 m	
	MP56-04/3-1	Köşe Gönye	...	200 Ad/Paket	
	MP33-09/4-3	Vasistas Makası	...	100 Ad/ Paket	
	MP56-07/5H	Seri Sistem Mentеше	...	200 Ad/ Paket	
	MP31-02/09-1	Paslanmaz Tek Büküm Oval Yale Kol	...	30 Ad/ Paket	
	MP31-11	Boru Kol	...	10 Ad/ Paket	
	MP32-01/1	Boyunlu Eksenel Kol Tek Dilli	...	50 Ad/ Paket	
	MP31-01	Yaylı Sosis Kol	...	50 Ad/ Paket	

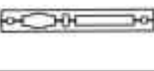
★ Yandaki profil birim ağırlıkları, bilgisayarda hesaplanmış teorik ağırlıklardır.

AKSESUAR KESİTİ	AKSESUAR KODU	AKSESUAR ADI	AĞIRLIK	PAKETLEME	SAYFA NO
	MP31-09/13	Yaylı Dar Aynalı Sosis Kol	...	30 Ad/ Paket	
	MP31-07/2Y	Yaylı Düz Rozetli Sosis Kol	...	50 Ad/ Paket	
	MP31-24/20	Akbank 40'lık Kol Aparatı	...	30 Ad/ Paket	
	MP31-24/2H	Akbank Havuzlu Kol Aparatı	...	30 Ad/ Paket	
	MP34-01/4/9	Carmen Nikel Barel(90mm)	...	24 Ad/ Paket	
	MP33-12	Isı yalıtımlı Uzun Sürgü	...	100 Ad/ Paket	
	MP34-04/5	Dilli Kilit (153-35)	...	30 Ad/ Paket	
	MP34-02/7	Makaralı Kilit (155-35)	...	30 Ad/ Paket	
	MP56-01/6/3-1	Dilli Kilit Karşılığı	...	50 Ad/ Paket	
	MP56-01/6/6	Makaralı Kilit Karşılığı	...	1 Ad/ Paket	
	MP32-34/3	İspanyolet Pim Takımı	...	100 Tk/ Paket	

★ Yandaki profil birim ağırlıkları, bilgisayarda hesaplanmış teorik ağırlıklardır.

AKSESUAR KESİTİ	AKSESUAR KODU	AKSESUAR ADI	AĞIRLIK	PAKETLEME	SAYFA NO
	MP33-15/5	Cico Avrupa Vasistas Çıtçıt	...	1 Ad/ Paket	
	MP32-33/1	Ayarlı Karşılık	...	500 Ad/ Paket	
	MP26-05	Su Tahliye Tapası	...	2000 Ad/ Paket	
	TS 71	Kapı Hidroliği	...	10 Ad/ Paket	
	MP33-04/2	Kapı Altı Fırçası	...	100 Ad/ Paket	
	MP33-04/3	Y Kapı Altı Fırçası	...	100 Ad/ Paket	
	HE-9991	Pvc Tij	...	200 m/ Paket	
	MP-9998	Kesme ve Delme Makinası	...	1 Ad/ Paket	

★ Yandaki profil birim ağırlıkları, bilgisayarda hesaplanmış teorik ağırlıklardır.

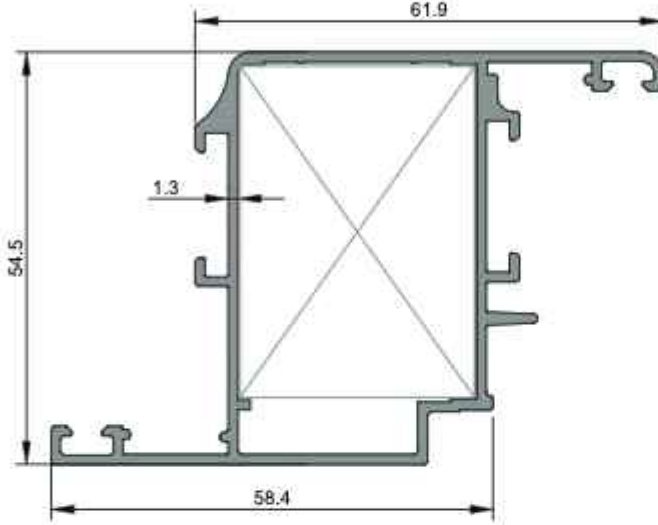

2383
Kapı Kanat Profili
1,018 kg/m
Jx=22,51 cm ⁴ Jy=8,69 cm ⁴

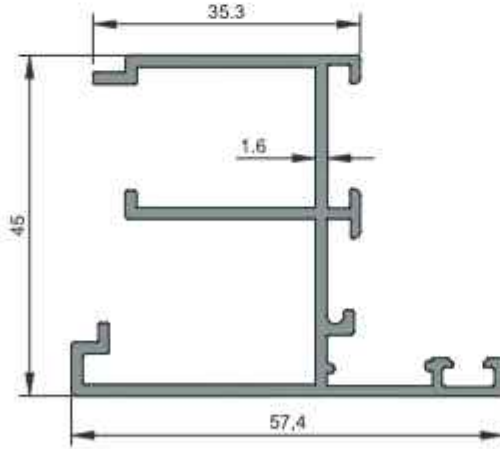

2976
İçe Açılır Çift Kanat Adaptörü
0,801 kg/m
Jx=8,57 cm ⁴ Jy=5,48 cm ⁴

★ Yandaki profil birim ağırlıkları, bilgisayarla hesaplanmış teorik ağırlıklardır.

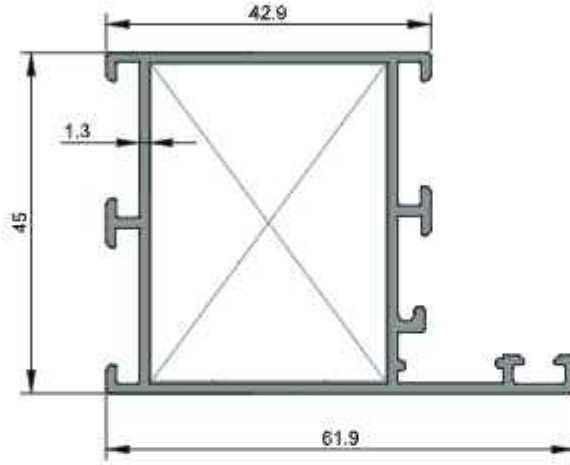

2381
Kasa Profili
0,815 kg/m
$J_x=11,60 \text{ cm}^4$ $J_y=7,05 \text{ cm}^4$

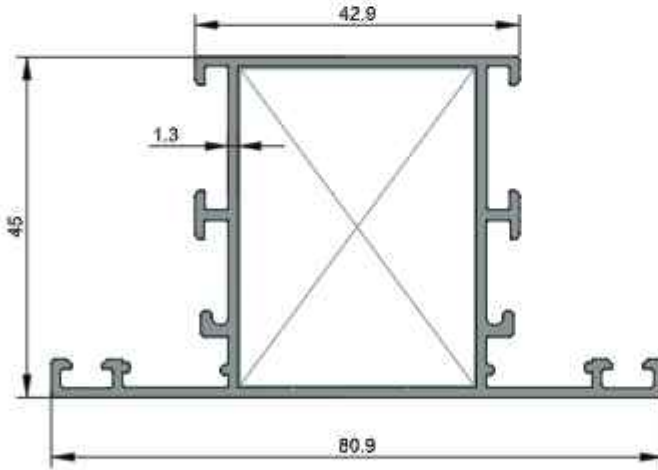

2382
Orta Kayıt Profili
0,939 kg/m
$J_x=14,65 \text{ cm}^4$ $J_y=10,07 \text{ cm}^4$

★ Yandaki profil birim ağırlıkları, bilgisayarla hesaplanmış teorik ağırlıklardır.

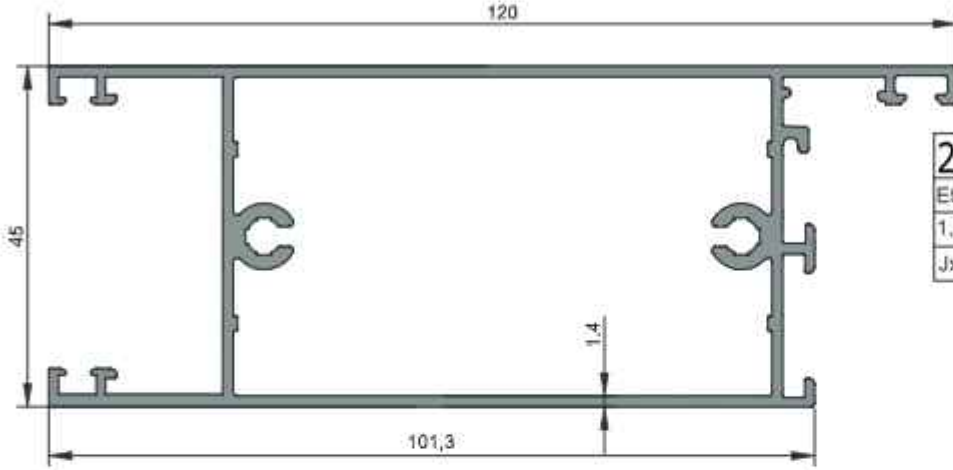

2960
Etek Profili
1,534 kg/m
Jx=72,60 cm ⁴ Jy=17,76 cm ⁴

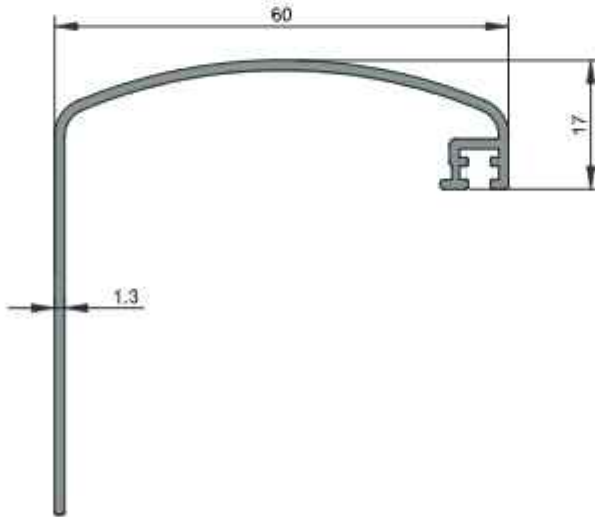

2259
60'lık Pervaz Profili
0,486 kg/m
Jx=11,88 cm ⁴ Jy=3,02 cm ⁴

★ Yandaki profil birim ağırlıkları, bilgisayarla hesaplanmış teorik ağırlıklardır.

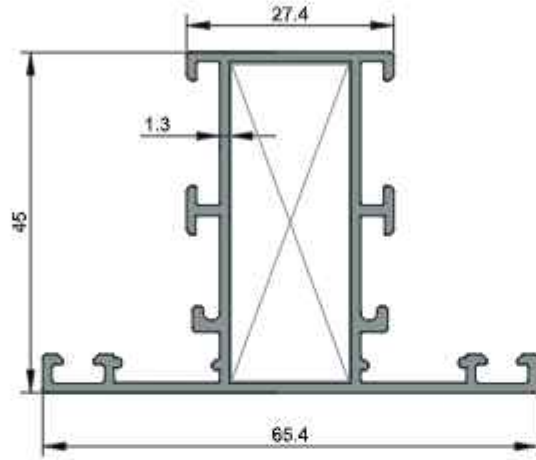

2958
Dar Orta Kayıt Profili
0,824 kg/m
Jx=7,98 cm ⁴ Jy=6,71 cm ⁴

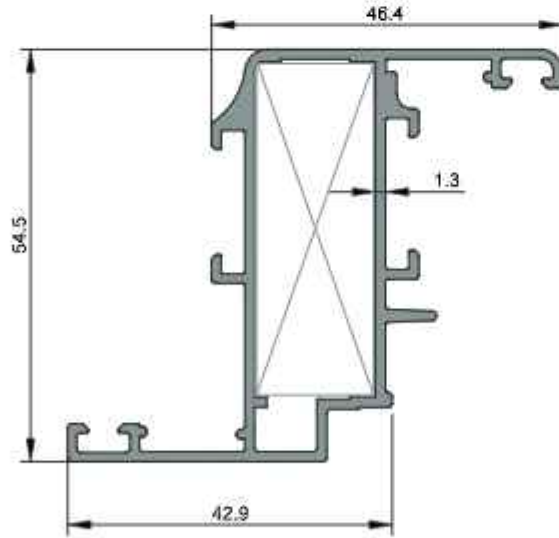

2959
Kanat Profili
0,908 kg/m
Jx=16,08 cm ⁴ Jy=3,93 cm ⁴

★ Yandaki profil birim ağırlıkları, bilgisayarda hesaplanmış teorik ağırlıklardır.

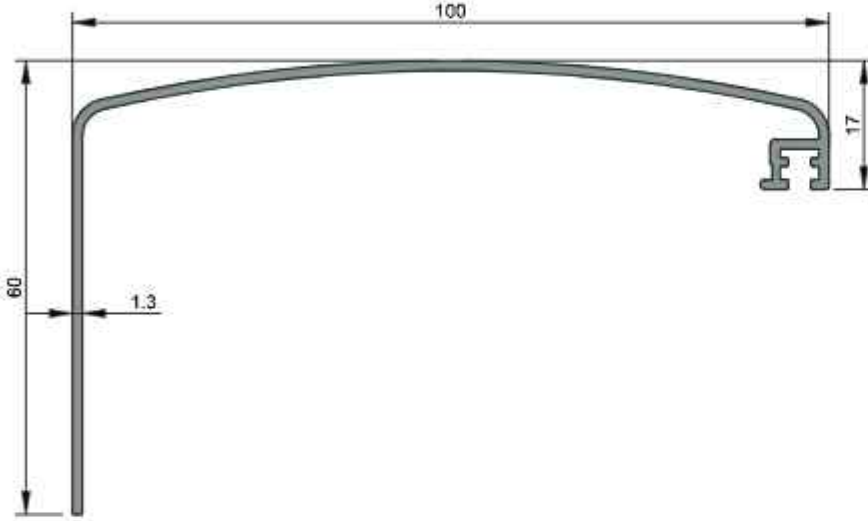

2260
100'lük Pervaz Profili
0,625 kg/m
$Jx=34,55 \text{ cm}^4$ $Jy=4,26 \text{ cm}^4$

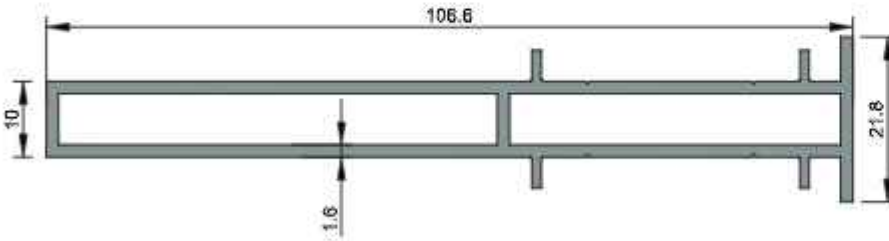

2385
Ek Bağlantı Profili
1,116 kg/m
$Jx=45,1 \text{ cm}^4$ $Jy=0,84 \text{ cm}^4$

★ Yandaki profil birim ağırlıkları, bilgisayarda hesaplanmış teorik ağırlıklardır.

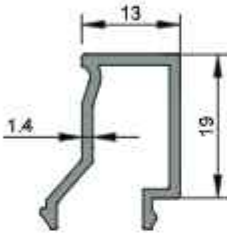

2508
Cam Çıtası
0,233 kg/m

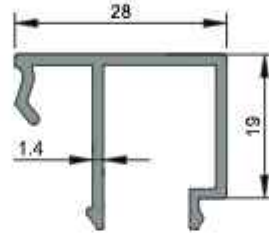

2507
Cam Çıtası
0,315 kg/m

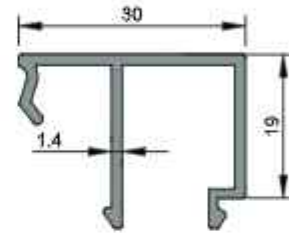

2384
Cam Çıtası
0,326 kg/m



1210
İspanyolet Çubuğu
0,112 kg/m

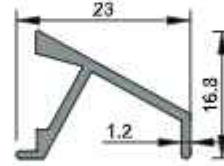

2181
Damlalık Profili
0,168 kg/m

KÖŞE TAKOZU KESİM ÖLÇÜLERİ

★ Yandaki profil birim ağırlıkları, bilgisayarda hesaplanmış teorik ağırlıklardır.

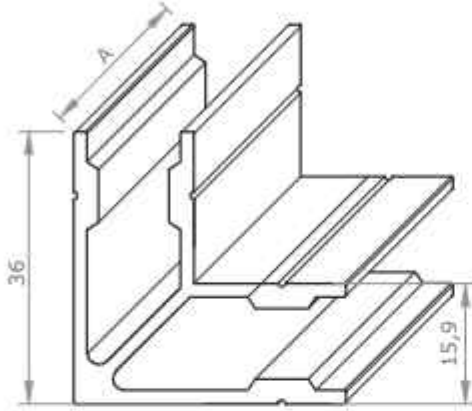

1333

Köşe Takozu

0,773 kg/m

Aksesuar Kodu	Profil Kodu	Kesim Ölçüsü A(mm)
K1333 419	2958	41.9
K1333 438	2959	43.8

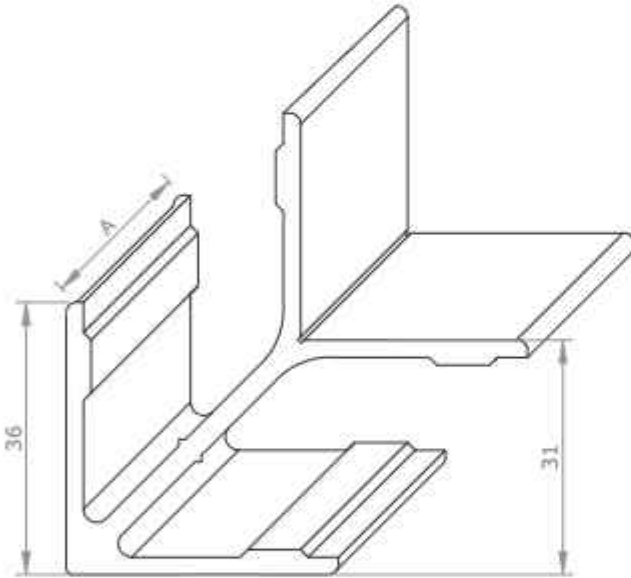

1948

Köşe Takozu

1,240 kg/m

Aksesuar Kodu	Profil Kodu	Kesim Ölçüsü A(mm)
K1948 419	2381	41.9
K1948 419	2382	41.9
K1948 438	2383	43.8

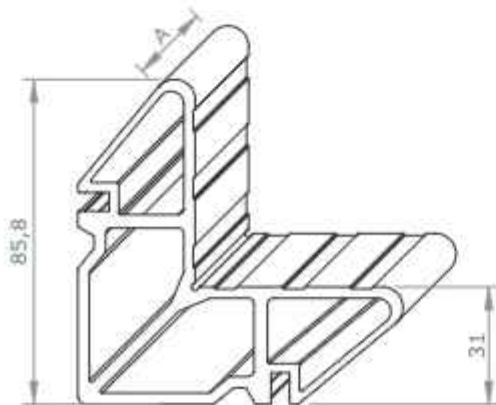

2491

Köşe Takozu

3,230 kg/m

Aksesuar Kodu	Profil Kodu	Kesim Ölçüsü A(mm)
K2491 419	2381	41.7
K2491 419	2382	41.7
K2491 438	2383	43.8

ORTA KAYIT BAĞLANTI KESİM ÖLÇÜLERİ

★ Yandaki profil birim ağırlıkları, bilgisayarla hesaplanmış teorik ağırlıklardır.

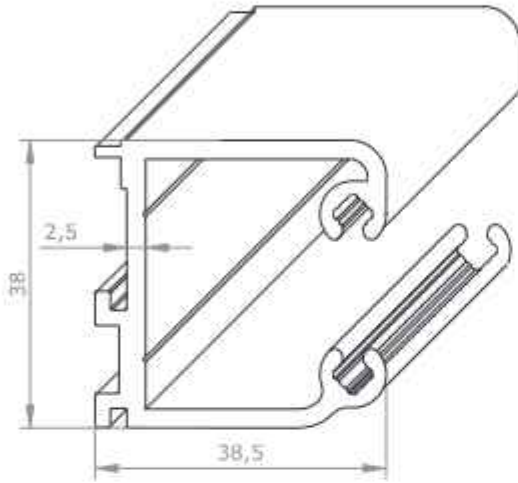

2386

Orta Kayıt Bağlantı Profili

0,989 kg/m

Aksesuar Kodu	Profil Kodu	Kesim Ölçüsü A(mm)
B2386 419	2958	41.9
B2386 419	2382	41.7

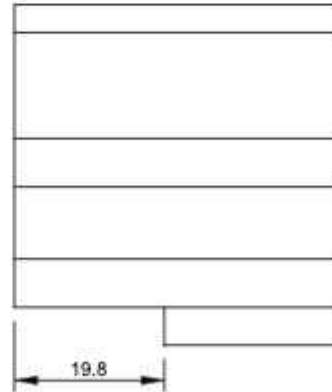
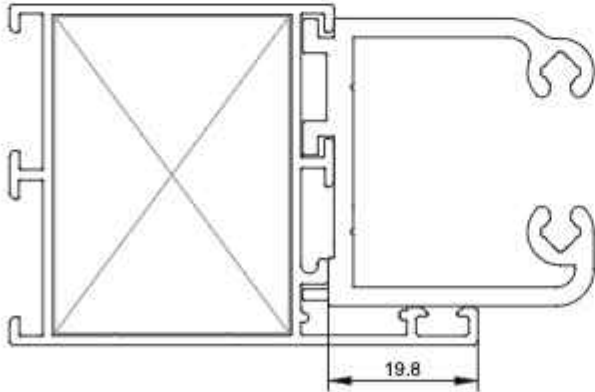

CAMLAMA SEÇENEK TABLOSU

ÖLÇEK:1/1

★ Yandaki profil birim ağırlıkları, bilgisayarda hesaplanmış teorik ağırlıklardır.

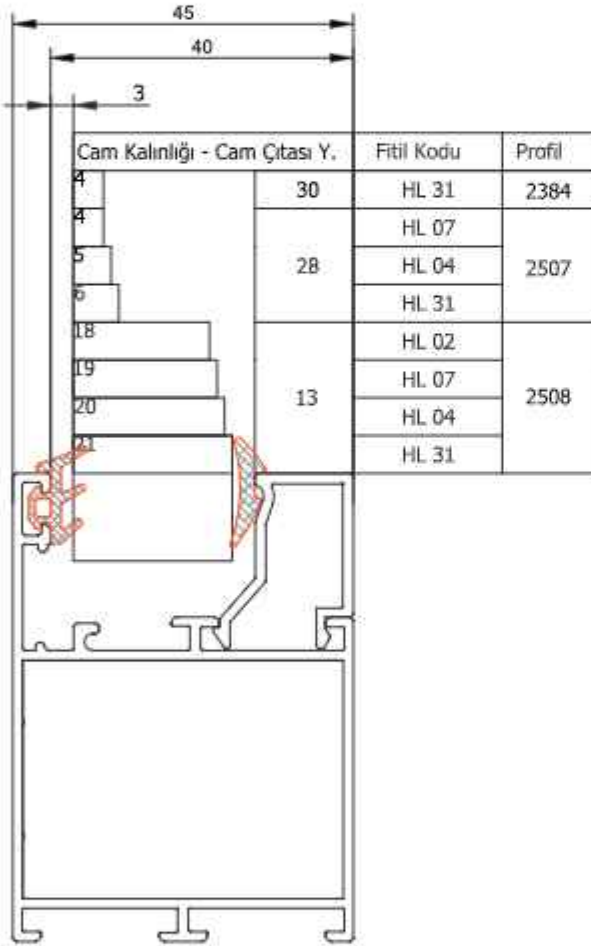

Cam Kalınlığı - Cam Çıtası Y.	Fitel Kodu	Profil
4	HL 31	2384
4	HL 07	2507
5	HL 04	
6	HL 31	
18	HL 02	2508
19	HL 07	
20	HL 04	
21	HL 31	

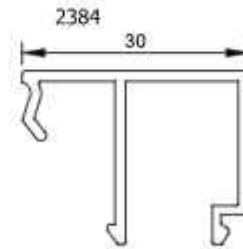
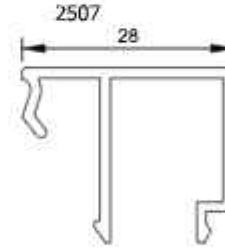
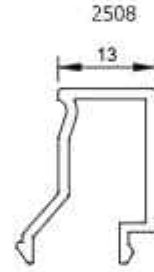

CAMLAMA SEÇENEK TABLOSU

ÖLÇEK:1/1

★ Yandaki profil birim ağırlıkları, bilgisayarla hesaplanmış teorik ağırlıklardır.

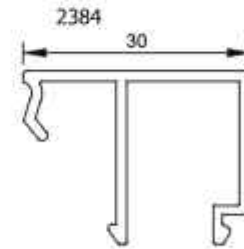
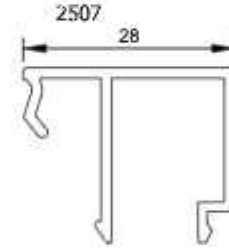
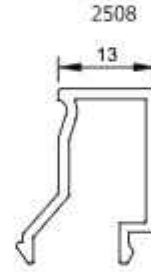
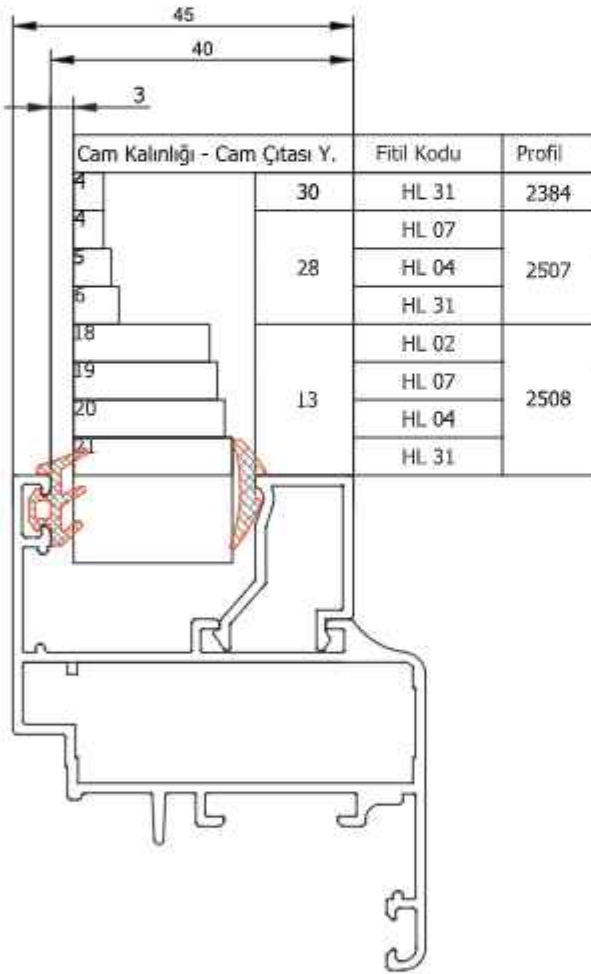

PENCERE UYGULAMA TİPLERİ

★ Yandaki profil birim ağırlıkları, bilgisayarda hesaplanmış teorik ağırlıklardır.

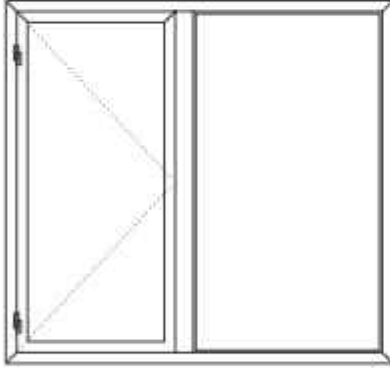
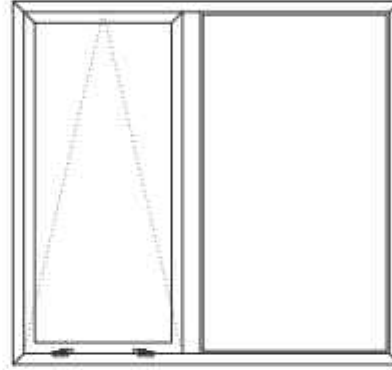
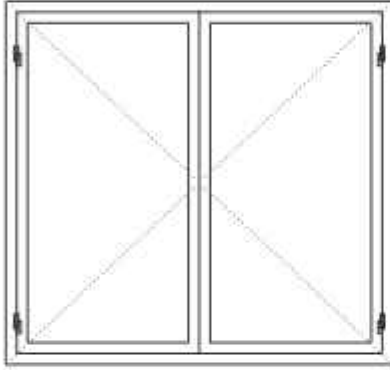

DETAY-1
ÖLÇEK:1/1

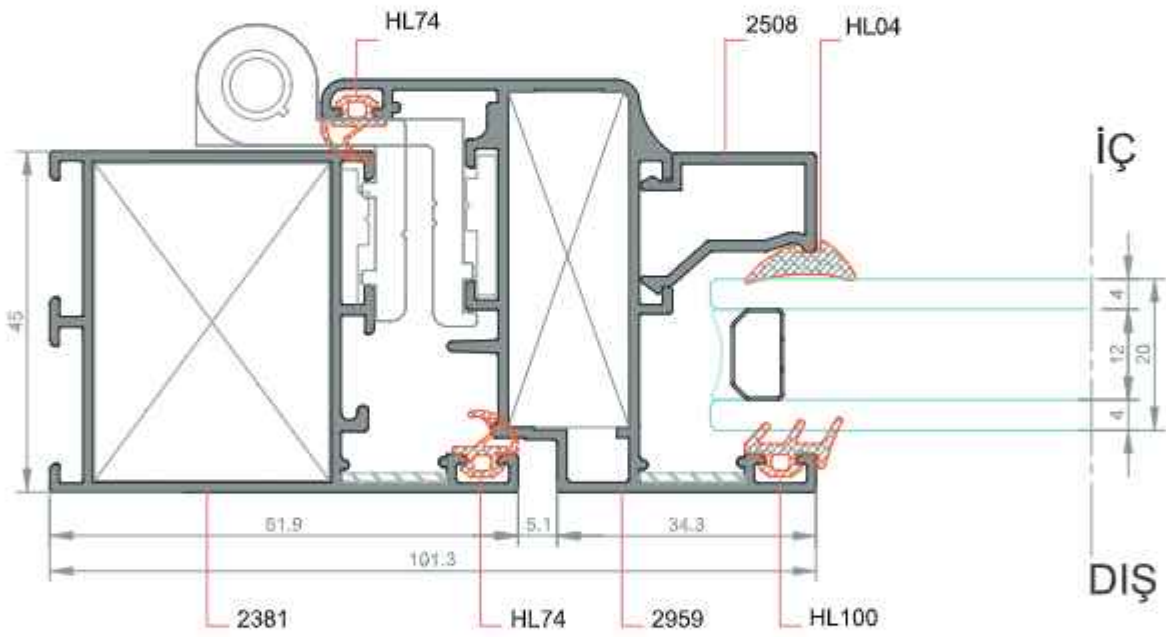
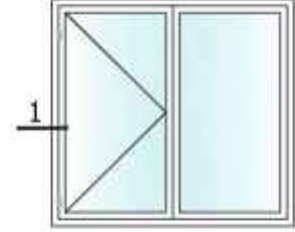

★ Yandaki profil birim ağırlıkları, bilgisayarla hesaplanmış teorik ağırlıklardır.

DETAY-2
ÖLÇEK:1/1

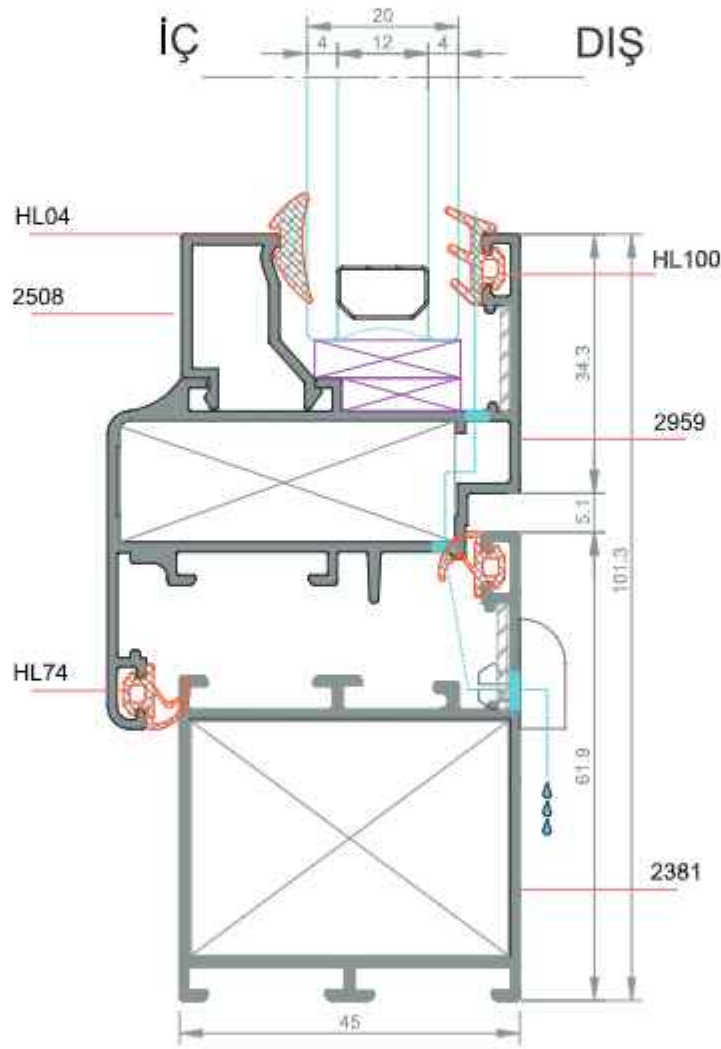
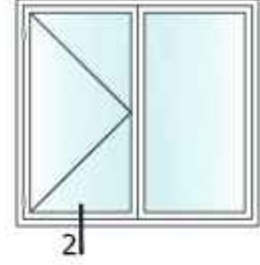

★ Yandaki profil birim ağırlıkları, bilgisayarla hesaplanmış teorik ağırlıklardır.

DETAY-3
ÖLÇEK:1/1

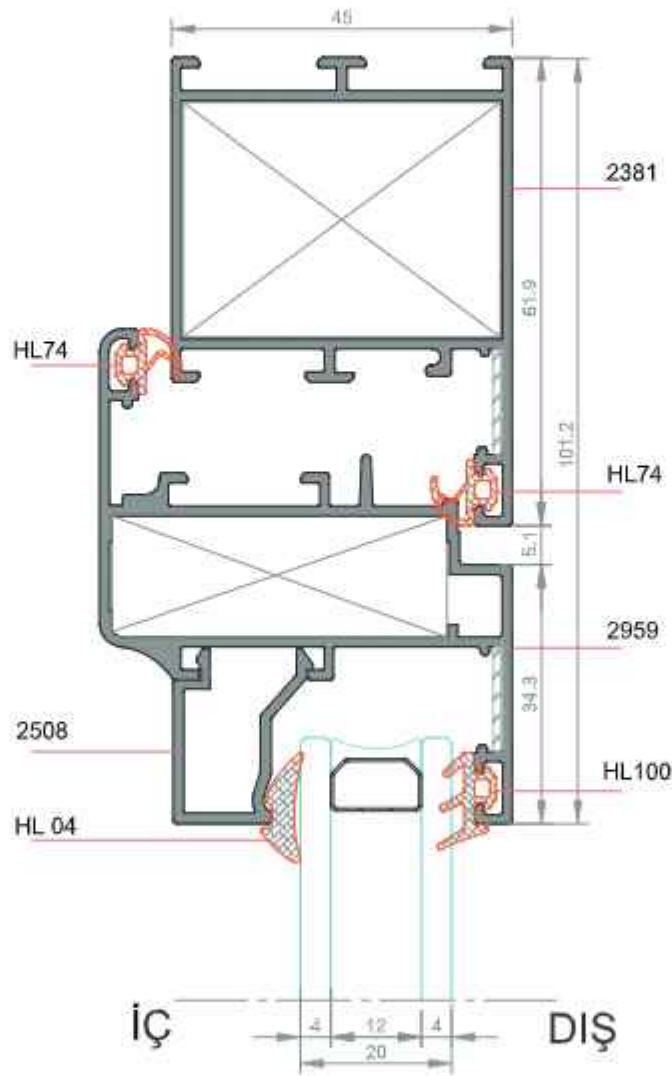
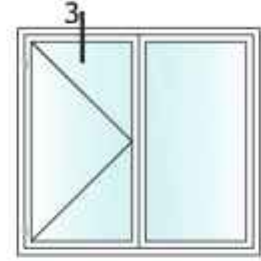

★ Yandaki profil birim ağırlıkları, bilgisayarda hesaplanmış teorik ağırlıklardır.

DETAY-4
ÖLÇEK:1/1

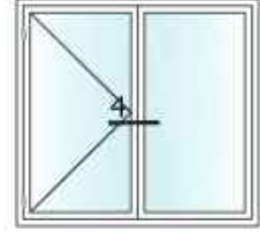

★ Yandaki profil ağırlıkları, bilgisayarla hesaplanmış teorik ağırlıklardır.

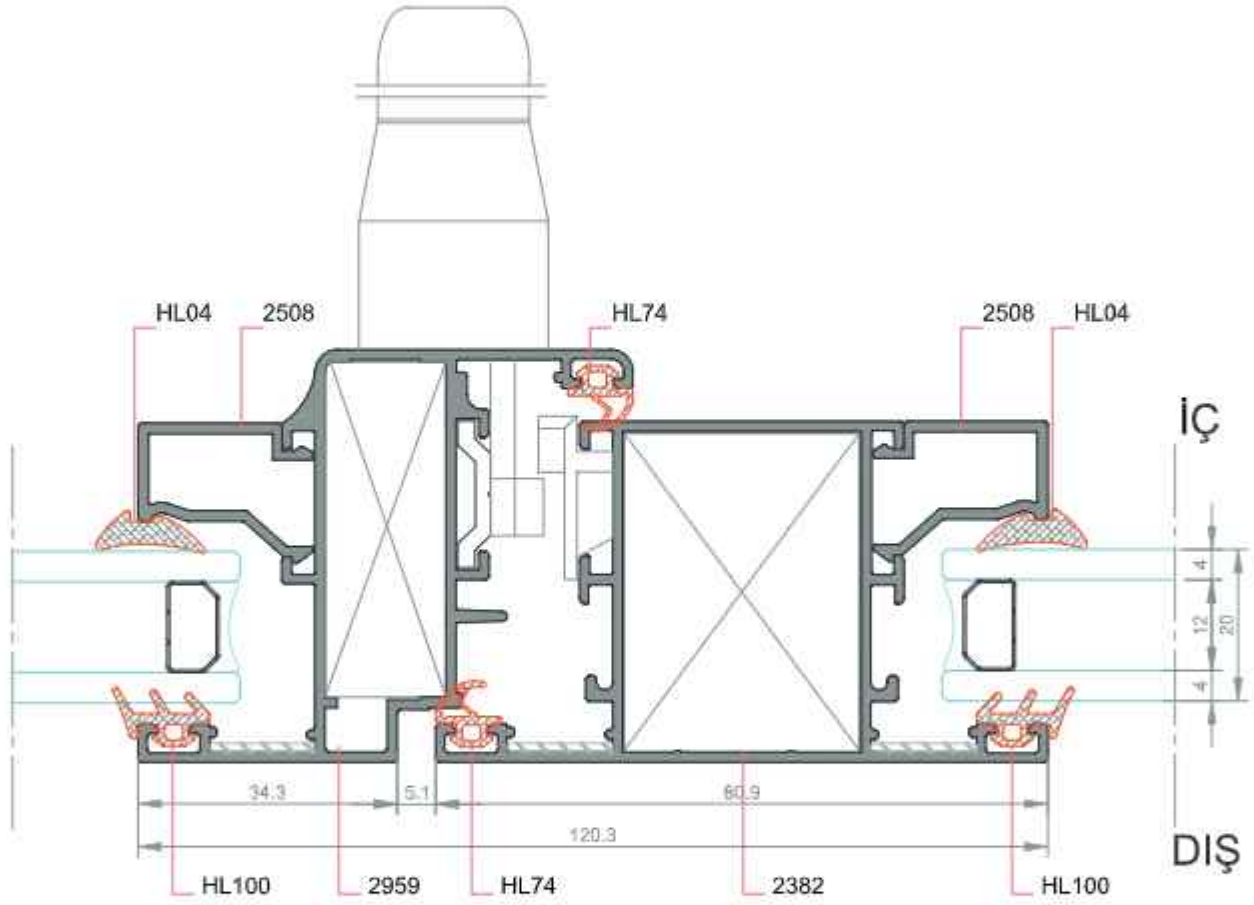

DETAY-5
ÖLÇEK:1/1

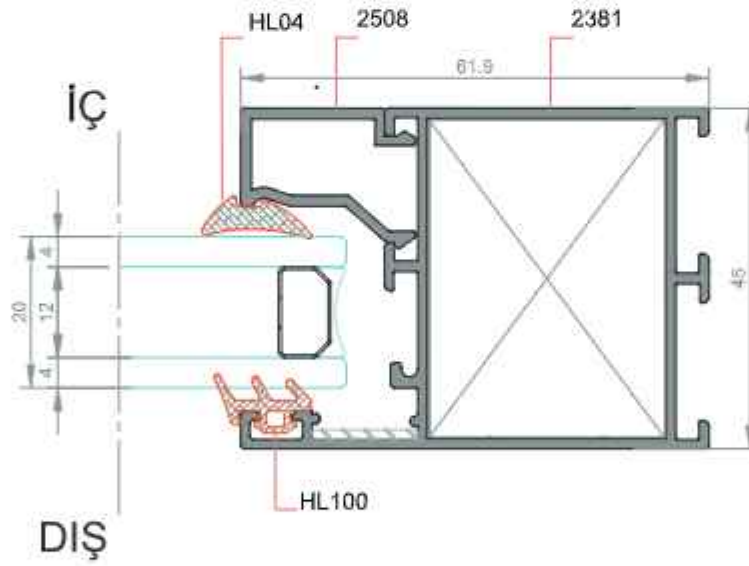
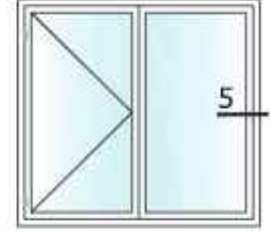

★ Yandaki profil birim ağırlıkları, bilgisayarla hesaplanmış teorik ağırlıklardır.

DETAY- 1a
ÖLÇEK:1/1

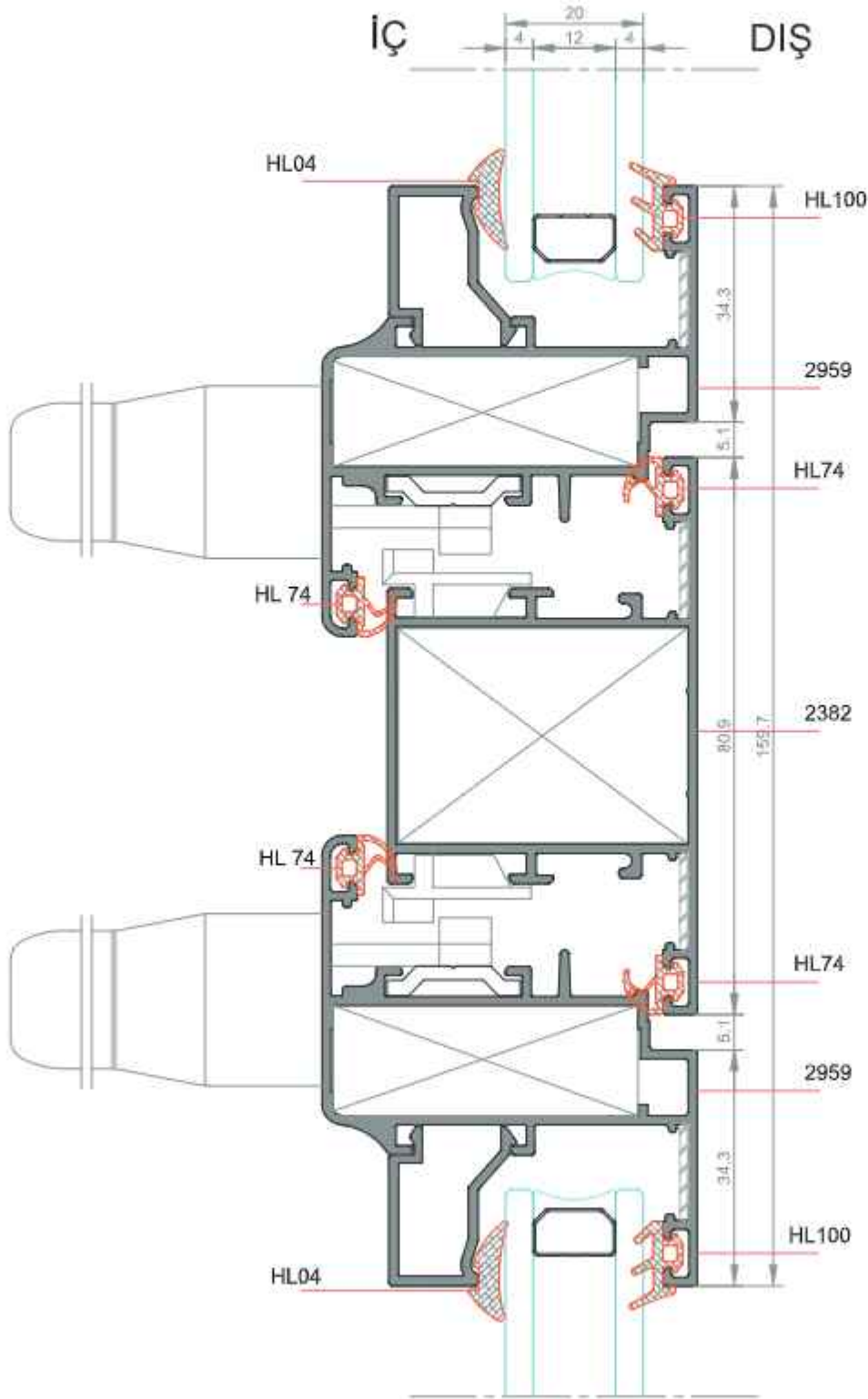

★ Yandaki profil birim ağırlıkları, bilgisayarda hesaplanmış teorik ağırlıklardır.

DETAY-1b
ÖLÇEK:1/1

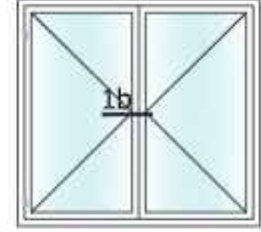

★ Yandaki profil birim ağırlıkları, bilgisayarda hesaplanmış teorik ağırlıklardır.

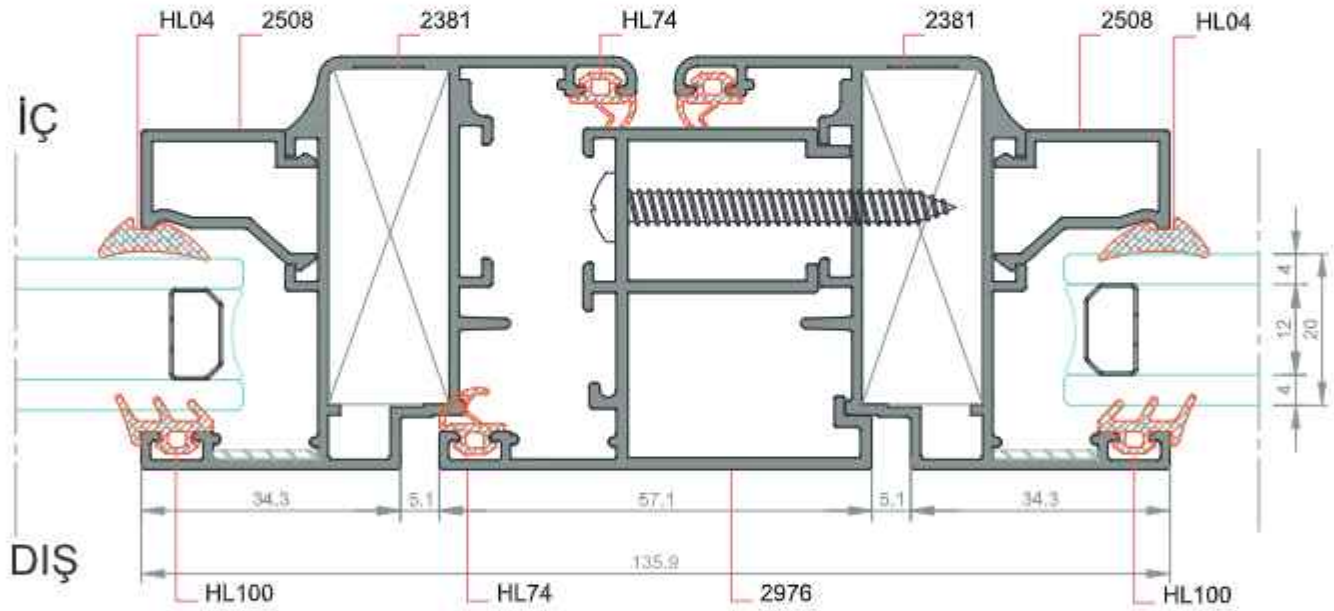

KAPI UYGULAMA TİPLERİ

★ Yandaki profil birim ağırlıkları, bilgisayarda hesaplanmış teorik ağırlıklardır.

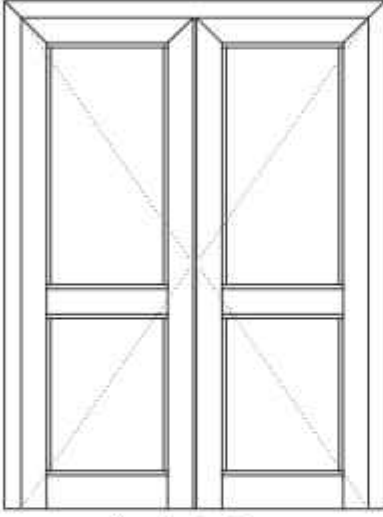

İçe Açılır Kapı



İçe Açılır Kapı

DETAY- 1
ÖLÇEK:1/1

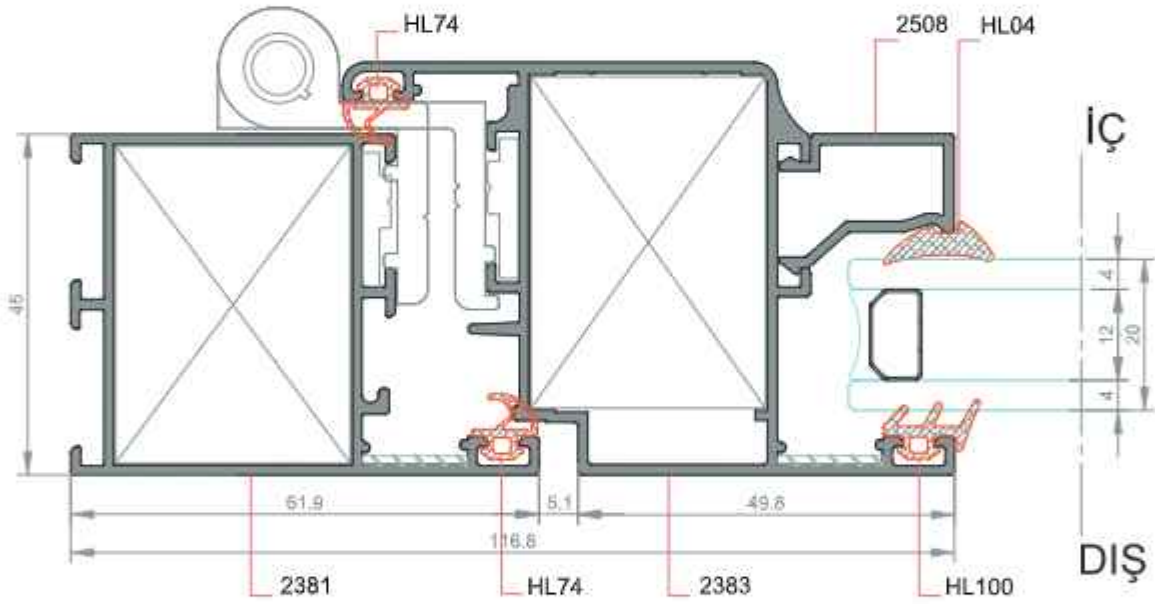

★ Yandaki profil birim ağırlıkları, bilgisayarla hesaplanmış teorik ağırlıklardır.

DETAY-2a
ÖLÇEK:1/1

★ Yandaki profil birim ağırlıkları, bilgisayarda hesaplanmış teorik ağırlıklardır.

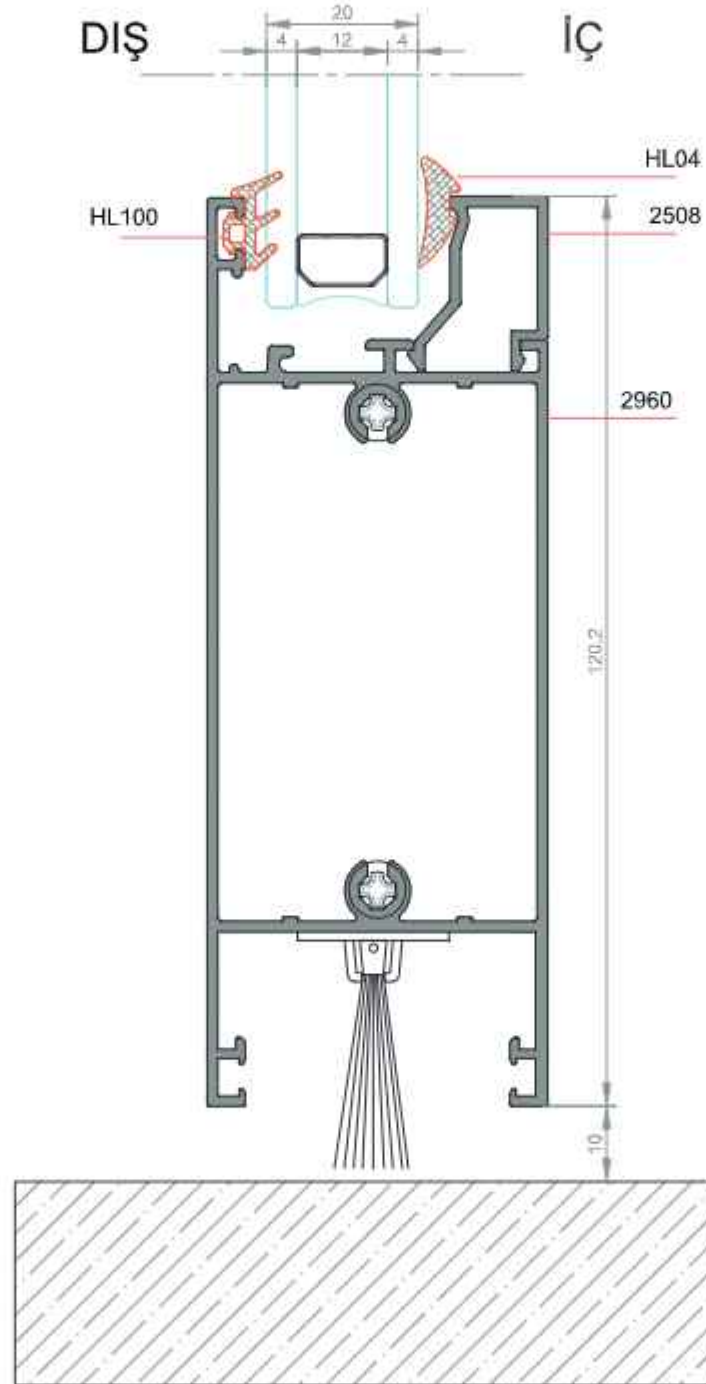

DETAY-2b
ÖLÇEK:1/1

★ Yandaki profil birim ağırlıkları, bilgisayarla hesaplanmış teorik ağırlıklardır.

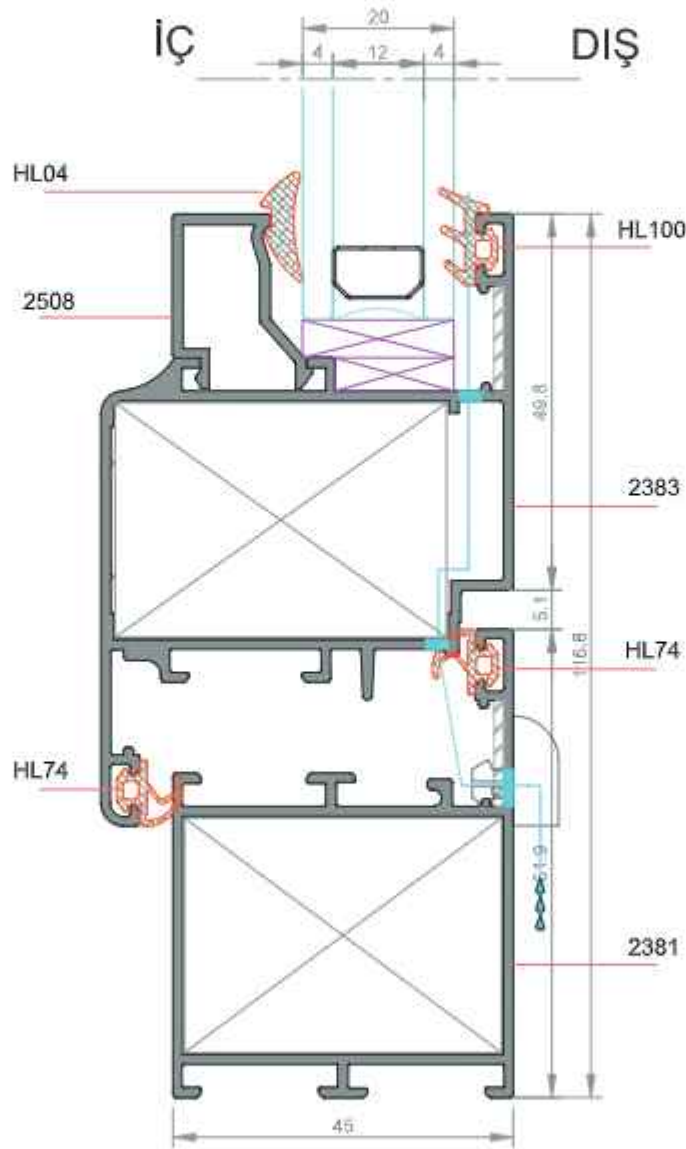

DETAY- 3
ÖLÇEK:1/1

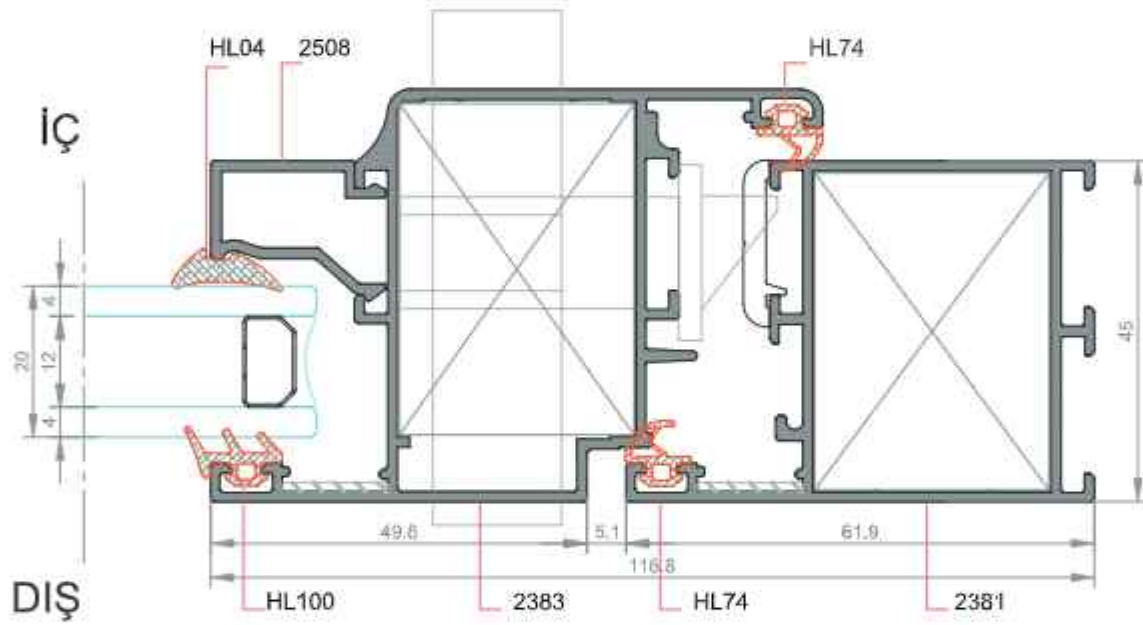
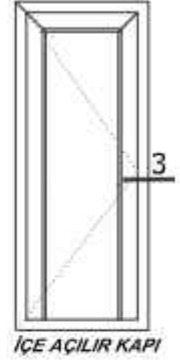

★ Yandaki profil birim ağırlıkları, bilgisayarda hesaplanmış teorik ağırlıklardır.

DETAY- 4
ÖLÇEK:1/1

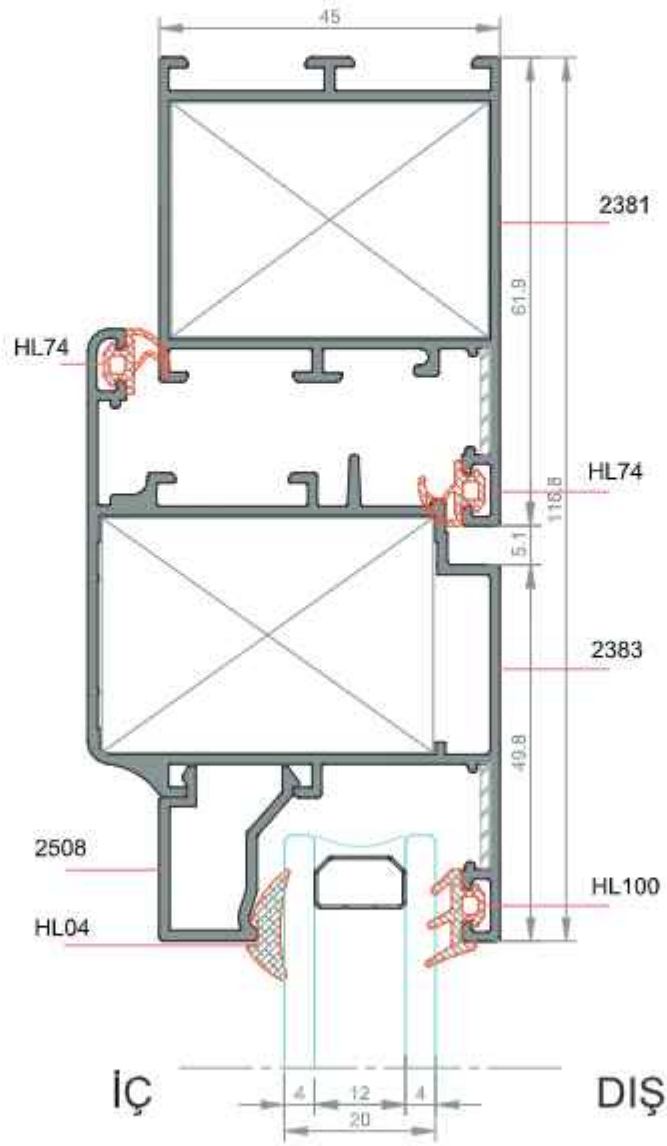

★ Yandaki profil birim ağırlıkları, bilgisayarda hesaplanmış teorik ağırlıklardır.

DETAY- 1
ÖLÇEK:1/1

★ Yandaki profil birim ağırlıkları, bilgisayarda hesaplanmış teorik ağırlıklardır.

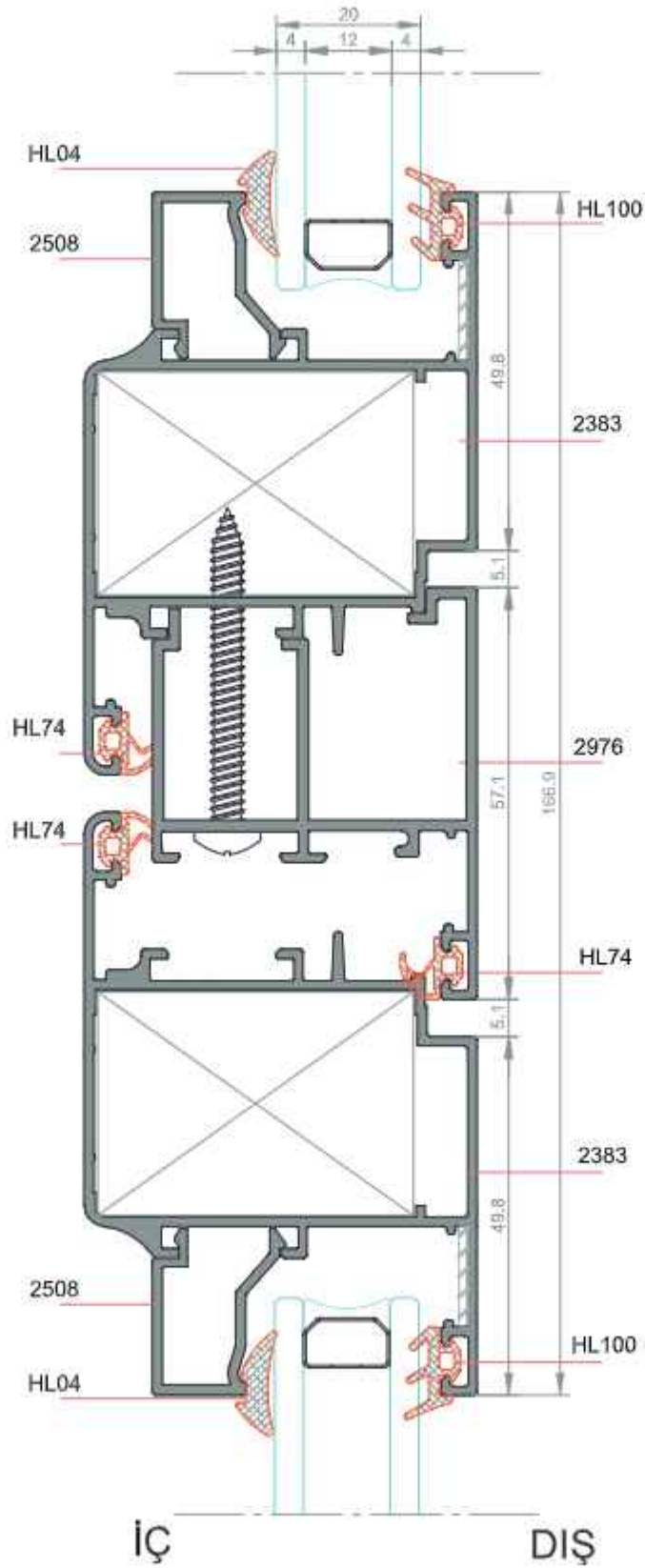

★ Yandaki profil birim ağırlıkları, bilgisayarla hesaplanmış teorik ağırlıklardır.

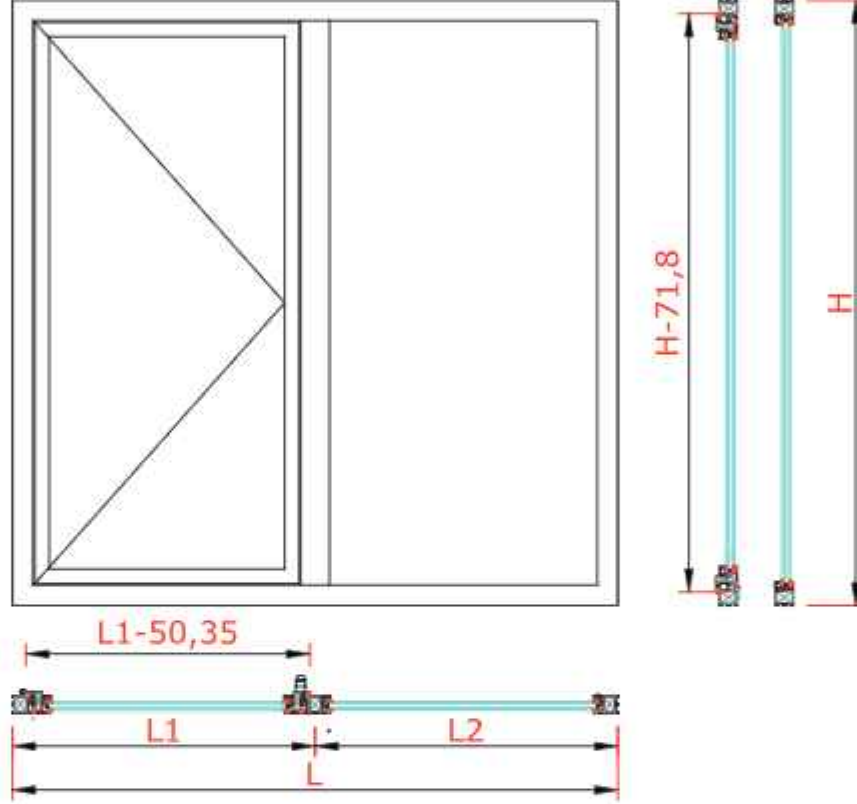

Profilin Adı	Profil Kesiti	Profil Kodu	Adet	Kesim Ölçüsü(mm)	Bağlantı Elemanları	Kod	Birim	Miktar										
Kasa Profili		2381	2		Köşe Takozu (Kasa)	K1948 419	Adet	4										
			2		Köşe Takozu (Kanat)	K1333 438	Adet	4										
Kanat Profili		2959	2		Orta Kayıt Bağlantı	B2386 419	Adet	2										
			2		Köşe Gönye (Kasa)	MP56-04/3-1	Adet	4										
Orta Kayıt Profili		2958	1		Köşe Gönye (Kanat)	MP56-04/3-1	Adet	4										
Cam Çıtası Profili	Kanat		2		<table border="1"> <thead> <tr> <th>Cam (Açılır)</th> <th>Adet</th> <th>Cam Detayı</th> <th>Kesim Ölçüsü (mm)</th> </tr> </thead> <tbody> <tr> <td>Dış Cam</td> <td rowspan="2">1</td> <td rowspan="2"></td> <td></td> </tr> <tr> <td>İç Cam</td> <td></td> </tr> </tbody> </table>				Cam (Açılır)	Adet	Cam Detayı	Kesim Ölçüsü (mm)	Dış Cam	1			İç Cam	
			Cam (Açılır)	Adet					Cam Detayı	Kesim Ölçüsü (mm)								
Dış Cam	1																	
İç Cam																		
2																		
Cam Çıtası Profili	Kasa Orta Kayıt		2		<table border="1"> <thead> <tr> <th>Cam (Sabit)</th> <th>Adet</th> <th>Cam Detayı</th> <th>Kesim Ölçüsü (mm)</th> </tr> </thead> <tbody> <tr> <td>Dış Cam</td> <td rowspan="2">1</td> <td rowspan="2"></td> <td></td> </tr> <tr> <td>İç Cam</td> <td></td> </tr> </tbody> </table>				Cam (Sabit)	Adet	Cam Detayı	Kesim Ölçüsü (mm)	Dış Cam	1			İç Cam	
			Cam (Sabit)	Adet					Cam Detayı	Kesim Ölçüsü (mm)								
Dış Cam	1																	
İç Cam																		
2																		

★ Yandaki profil birim ağırlıkları, bilgisayarda hesaplanmış teorik ağırlıklardır.

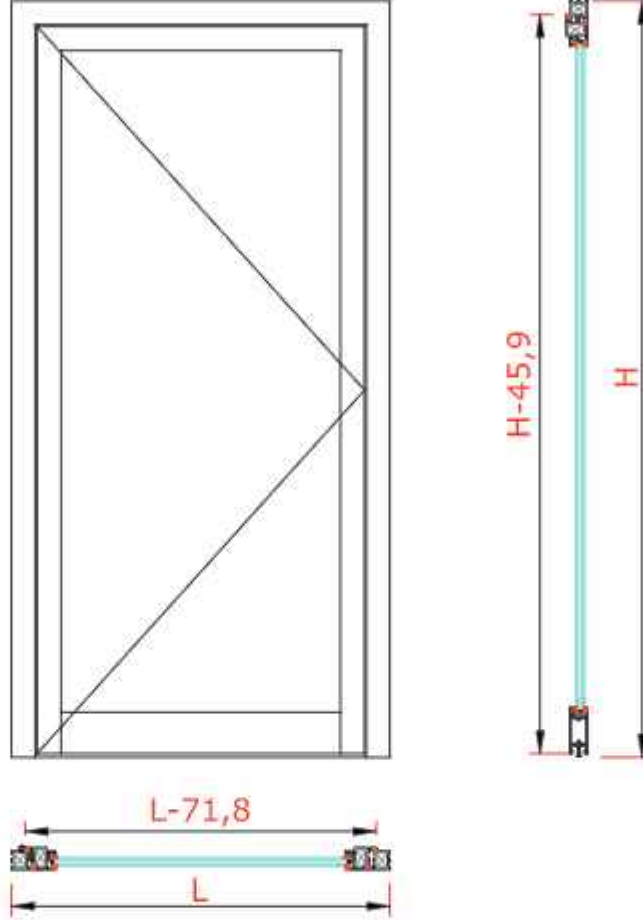

Profilin Adı	Profil Kesiti	Profil Kodu	Adet	Kesim Ölçüsü(mm)
Kasa Profili		2381	1	L
			2	H
Kanat Profili		2383	1	L-71,8
			2	H-45,9
Etek Profili		2960	1	L-186,8
Cam Çıtası Profili <small>Not: İç Cam (ısıtılabilir) profiline L=154 kullanılır. Ayrıca</small>	Kanat		2	
			2	

Bağlantı Elemanları	Kod	Birim	Miktar
Köşe Takozu (Kasa)	K1948 419	Adet	2
Köşe Takozu (Kanat)	K1948 438	Adet	2
Köşe Gönye (Kasa)	MP56-04/3-1	Adet	2
Köşe Gönye (Kanat)	MP56-04/3-1	Adet	2

CAM (Açılır)	Adet	Cam Detayı	Kesim Ölçüsü (mm)
Dış Cam	1		
İç Cam			



PROFİL KATALOĐU











GXY H55 ISI YALITIMSIZ KAPI VE PENCERE SİSTEMLERİ

*GXY H55 THERMAL UNINSULATED DOOR &
WINDOW SYSTEMS*

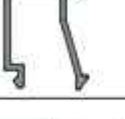







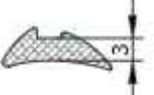
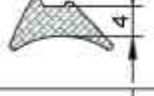

* Profil Ađırlıkları Teorik Olup Teslim Anındaki Ađırlık Geerlidir

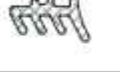
* *Weight of profiles are theoretical, net weight will valid at the time of delivery.*





★ Yandaki profil birim ağırlıkları, bilgisayarda hesaplanmış teorik ağırlıklardır.

PROFİL KESİTİ	PROFİL KODU	PROFİL ADI	AĞIRLIK	ATALET MOMENTLERİ		SAYFA NO
				J_x (cm ⁴)	J_y (cm ⁴)	
	3032	Kasa Profili	1,010 kg/m	17,19	8,23	
	3034	Orta Kayıt Profili	1,214 kg/m	18,64	14,45	
	3033P	Kanat Profili	1,301 kg/m	30,53	10,47	
	3033K	Kanat Profili	1,418 kg/m	40,48	20,72	
	3036	Orta Baza Profili	1,433 kg/m	36,64	24,47	
	3039	Çift Kanat Adaptörü	0,887 kg/m	13,55	5,69	
	3035	Etek Profili	1,574 kg/m	54,85	28,35	
	3038	Cam Çıtası	0,228 kg/m	
	3037	Cam Çıtası	0,292 kg/m	
	1210	İspanyolet Çubuğu	0,112 kg/m	
	2181	Damlalık Profili	0,168 kg/m	
	3230	Köşe Dönüş Adaptörü	0,180 kg/m	
	3040	Köşe Takoza	3,697 kg/m	
	3041	Köşe Takoza	4,604 kg/m	

★ Yandaki profil birim ağırlıkları, bilgisayarda hesaplanmış teorik ağırlıklardır.

AKSESUAR KESİTİ	AKSESUAR KODU	AKSESUAR ADI	AĞIRLIK	PAKETLEME	SAYFA NO
	HL04	İç Cam Fiteli - 3 mm	60 gr/m	15 kg/ 250 m	
	HL07	İç Cam Fiteli - 4 mm	63 gr/m	15 kg/ 238 m	
	HL02	İç Cam Fiteli - 4.5 mm	85 gr/m	15 kg/ 175 m	
	HL47	Dış Cam Fiteli	43 gr/m	15 kg/ 348 m	
	HL40	Dış Bini Fiteli	25 gr/m	15 kg/ 600 m	
	MP32-20/H55	Sistem Mentşesi	...	250 Ad/ Paket	
	MP33-09/4-3	Vasistas Makası	...	100 Ad/ Paket	
	MP-6-36138 -20-LR-0-1	Mentşe	...	1 Ad/ Paket	
	MP33-04/2	Kapı Altı Fırçası	...	100 Ad/ Paket	
	MP31-02/09-1	Paslanmaz Tek Büküm Oval Yale Kol	...	30 Ad/ Paket	
	MP31-11	Boru Kol	...	10 Ad/ Paket	
	MP29-04	Alüminyum Pencere Kolu	...	100 Ad/ Paket	
	MP32-01/1	Boyunlu Eksenel Kol Tek Dilli	...	50 Ad/ Paket	
	MP31-01	Yaylı Sosis Kol	...	50 Ad/ Paket	

★ Yandaki profil birim ağırlıkları, bilgisayarda hesaplanmış teorik ağırlıklardır.

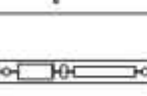
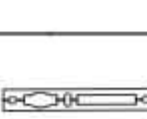
AKSESUAR KESİTİ	AKSESUAR KODU	AKSESUAR ADI	AĞIRLIK	PAKETLEME	SAYFA NO
	MP31-09/13	Yaylı Dar Aynalı Sosis Kol	...	30 Ad/ Paket	
	MP31-07/2Y	Yaylı Düz Rozetli Sosis Kol	...	50 Ad/ Paket	
	MP31-24/20	Akbank 40'lık Kol Aparatı	...	30 Ad/ Paket	
	MP31-24/2H	Akbank Havuzlu Kol Aparatı	...	30 Ad/ Paket	
	MP34-01/4/9	Carmen Nikel Barel(90mm)	...	24 Ad/ Paket	
	MP33-12	Isı yalıtımlı Uzun Sürgü	...	100 Ad/ Paket	
	MP34-04/5	Dilli Kilit (153-35)	...	30 Ad/ Paket	
	MP34-02/7	Makaralı Kilit (155-35)	...	30 Ad/ Paket	
	MP56-01/6/3-1	Dilli Kilit Karşılığı	...	50 Ad/ Paket	
	MP56-01/6/6	Makaralı Kilit Karşılığı	...	50 Ad/ Paket	
	MP32-34/3	İspanyolet Pim Takımı	...	100 Tk/ Paket	

★ Yandaki profil birim ağırlıkları, bilgisayarda hesaplanmış teorik ağırlıklardır.

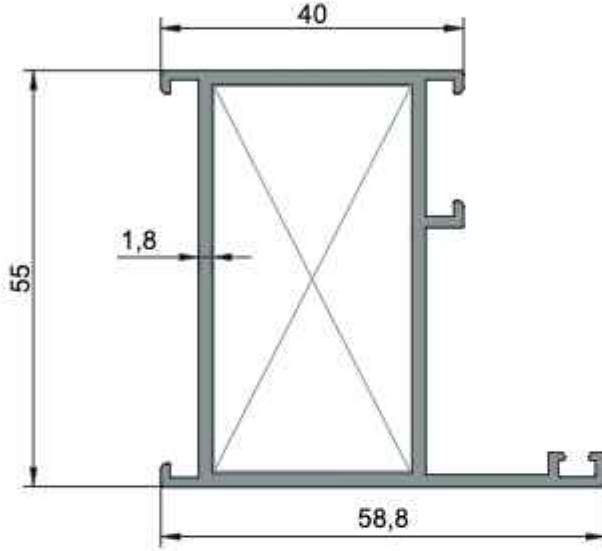

3032
Kasa Profili
1,010 kg/m
$J_x=17,19 \text{ cm}^4$ $J_y=8,23 \text{ cm}^4$

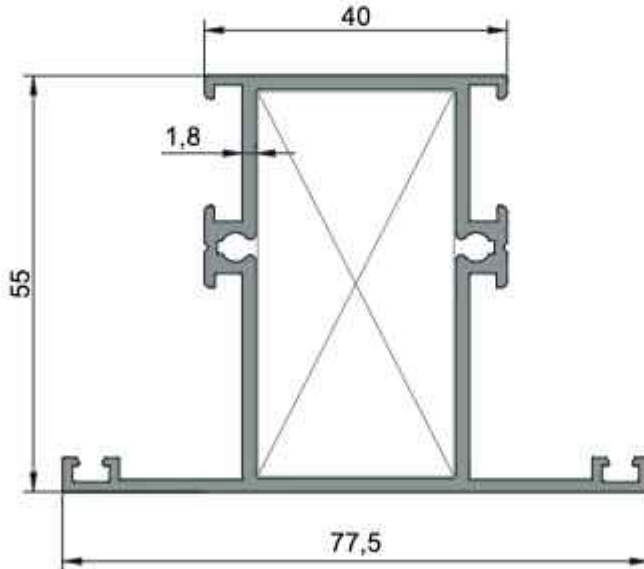

3034
Orta Kayıt Profili
1,214 kg/m
$J_x=18,64 \text{ cm}^4$ $J_y=14,45 \text{ cm}^4$

★ Yandaki profil birim ağırlıkları, bilgisayarda hesaplanmış teorik ağırlıklardır.

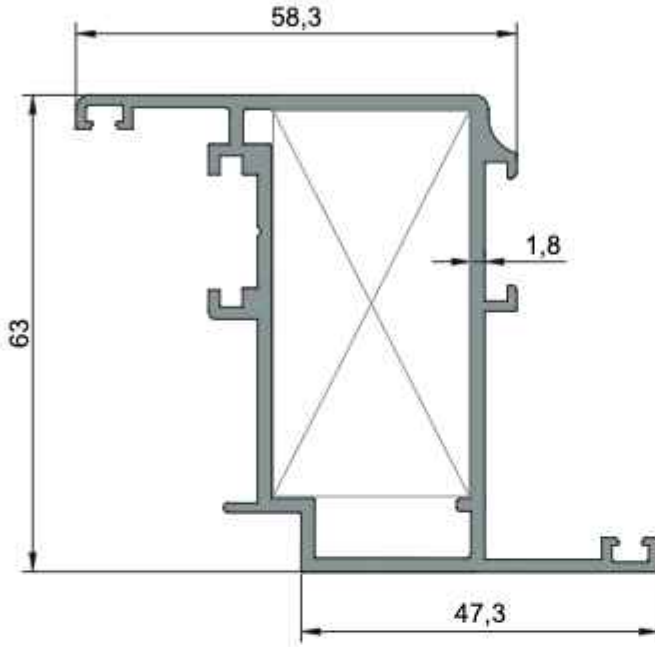

3033P
Kanat Profili
1,301 kg/m
$J_x=30,53 \text{ cm}^4$ $J_y=10,47 \text{ cm}^4$

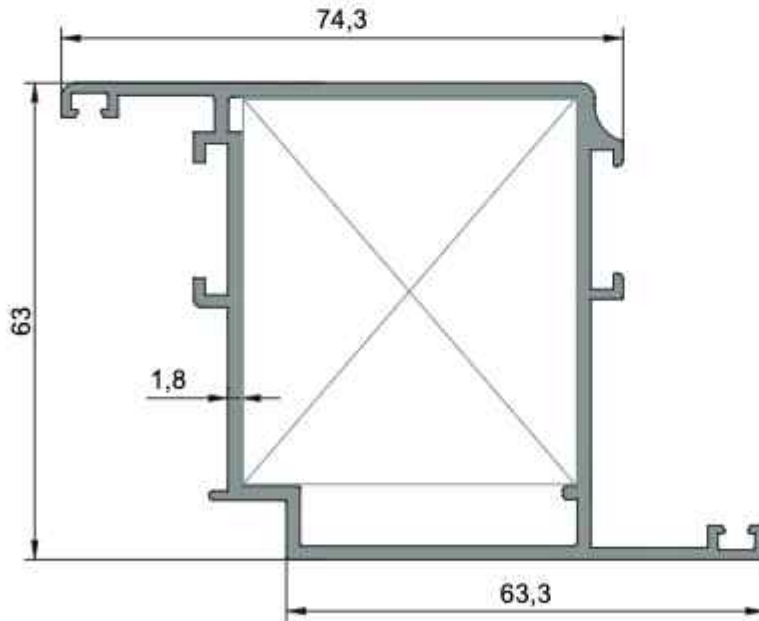

3033K
Kanat Profili
1,418 kg/m
$J_x=40,48 \text{ cm}^4$ $J_y=20,72 \text{ cm}^4$

★ Yandaki profil birim ağırlıkları, bilgisayarla hesaplanmış teorik ağırlıklardır.

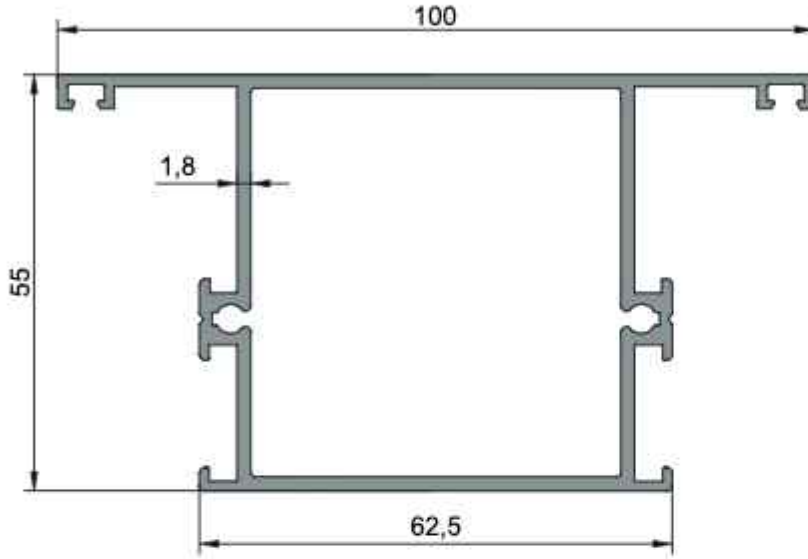

3036

Orta Baza Profili

1,433 kg/m

$J_x=36,64 \text{ cm}^4$ $J_y=24,47 \text{ cm}^4$

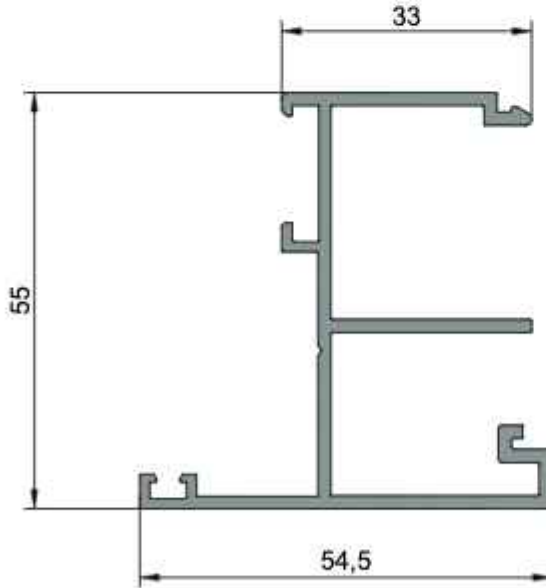

3039

Çift Kanat Adaptörü

0,887 kg/m

$J_x=13,55 \text{ cm}^4$ $J_y=5,69 \text{ cm}^4$

★ Yandaki profil birim ağırlıkları, bilgisayarda hesaplanmış teorik ağırlıklardır.

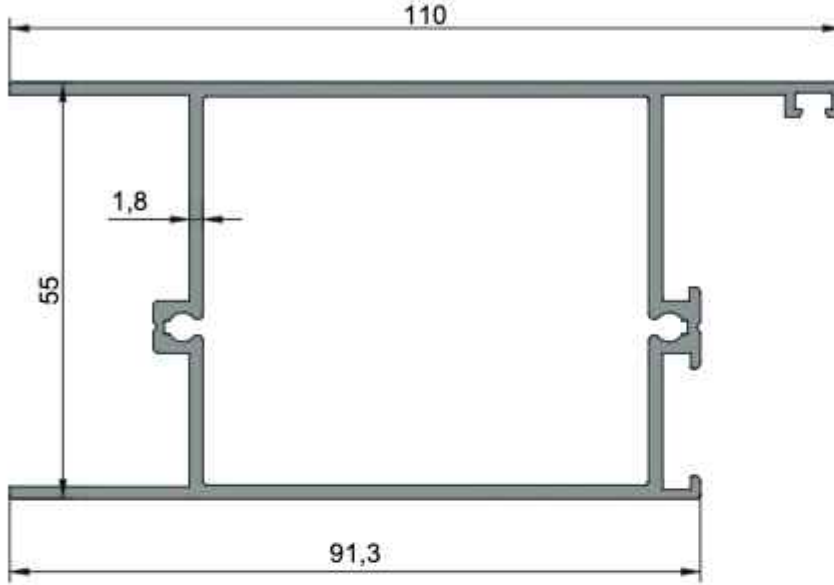

3035
Etek Profili
1,574 kg/m
Jx=54,85 cm ⁴ Jy=28,35 cm ⁴

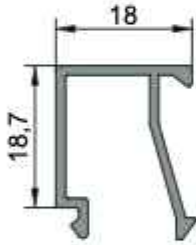

3038
Cam Çıtası
0,228 kg/m

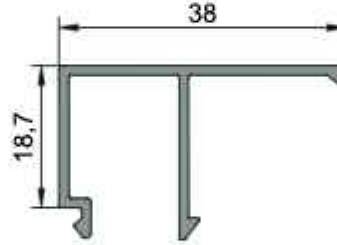

3037
Cam Çıtası
0,292 kg/m

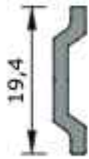

1210
İspanyolet Çubuğu
0,112 kg/m

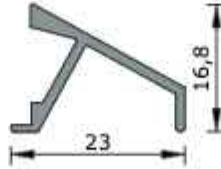

2181
Damlalık Profili
0,168 kg/m

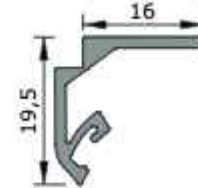

3230
Köşe Dönüş Adaptörü
0,180 kg/m

KÖŞE TAKOZU KESİM ÖLÇÜLERİ

★ Yandaki profil birim ağırlıkları, bilgisayararda hesaplanmış teorik ağırlıklardır.

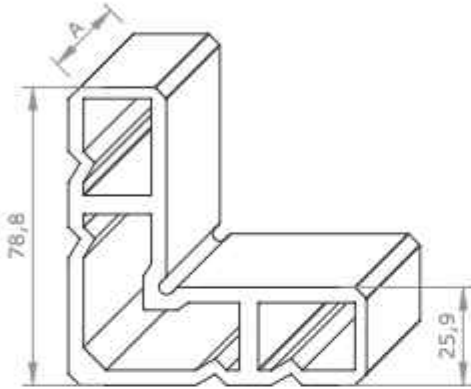

3040
H55 Kasa Köşe Takozu
3,697 kg/m

Aksesuar Kodu	Profil Kodu	Kesim Ölçüsü A(mm)
K3040 509	3032	50.9
K3040 510	3033P	51.0
K3040 509	3034	50.9

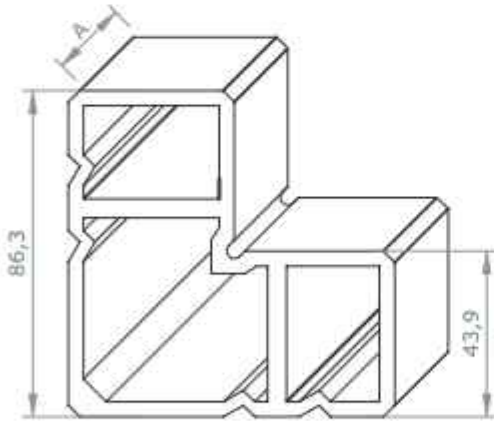

3041
H55 Kapı Köşe Takozu
4,604 kg/m

Aksesuar Kodu	Profil Kodu	Kesim Ölçüsü A(mm)
K3041 510	3033K	51.0

CAMLAMA SEÇENEK TABLOSU

ÖLÇEK:1/1

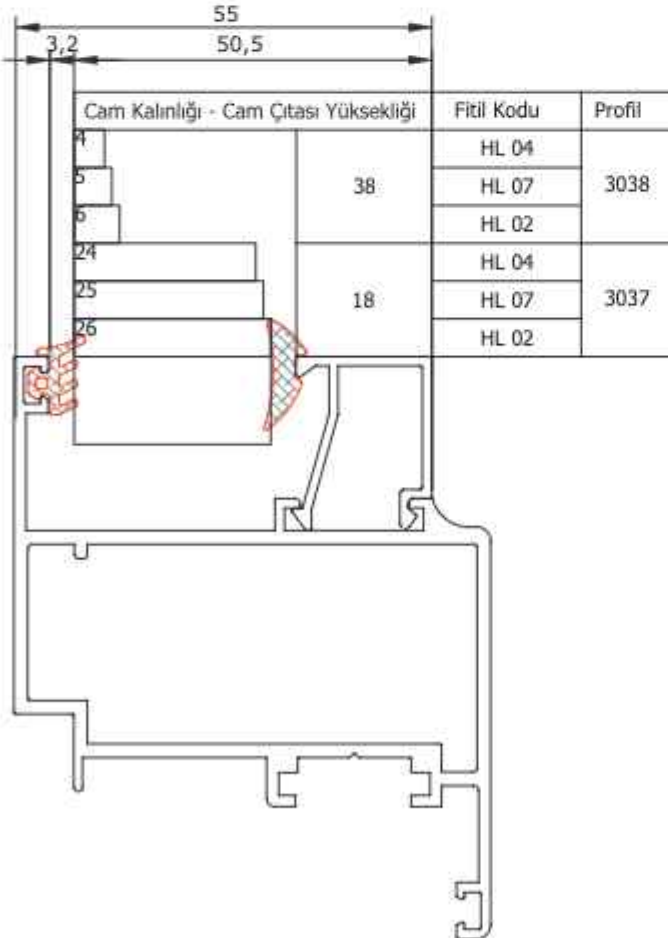
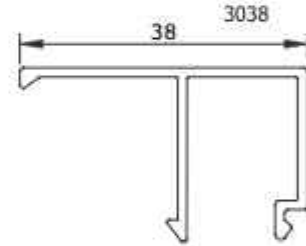
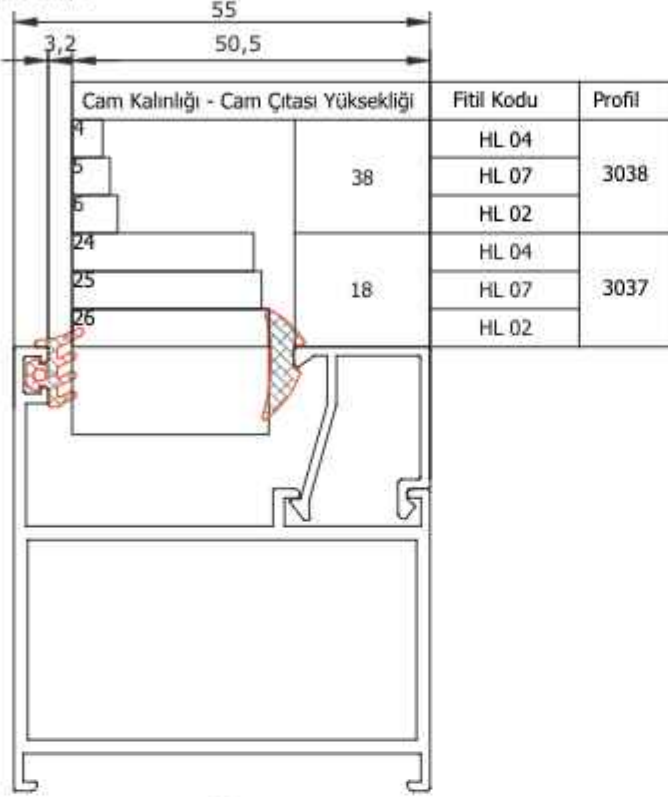

★ Yandaki profil birim ağırlıkları, bilgisayarla hesaplanmış teorik ağırlıklardır.

PENCERE UYGULAMA TİPLERİ

★ Yandaki profil birim ağırlıkları, bilgisayarla hesaplanmış teorik ağırlıklardır.

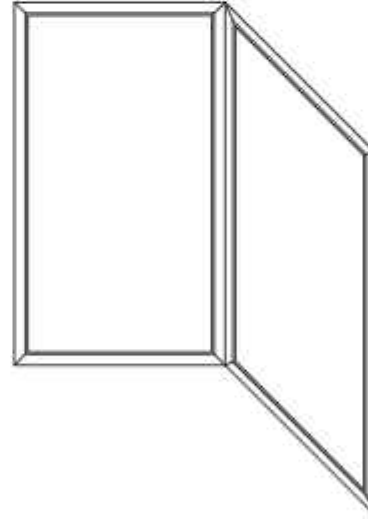
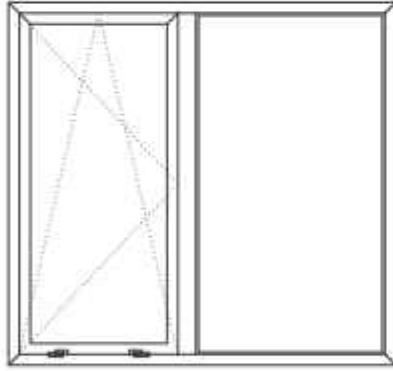
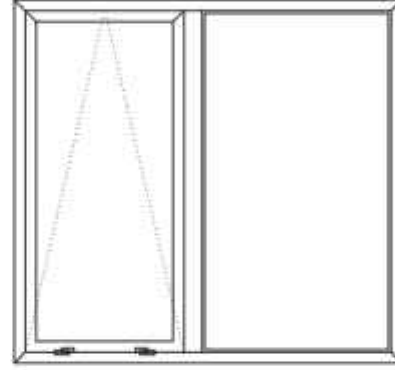
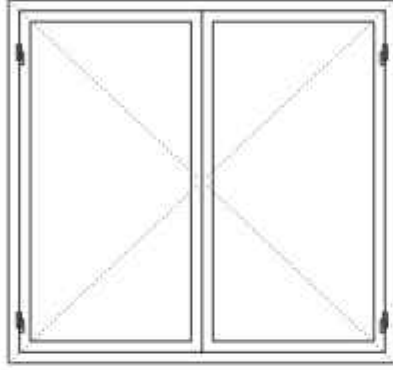

DETAY-1
ÖLÇEK:1/1

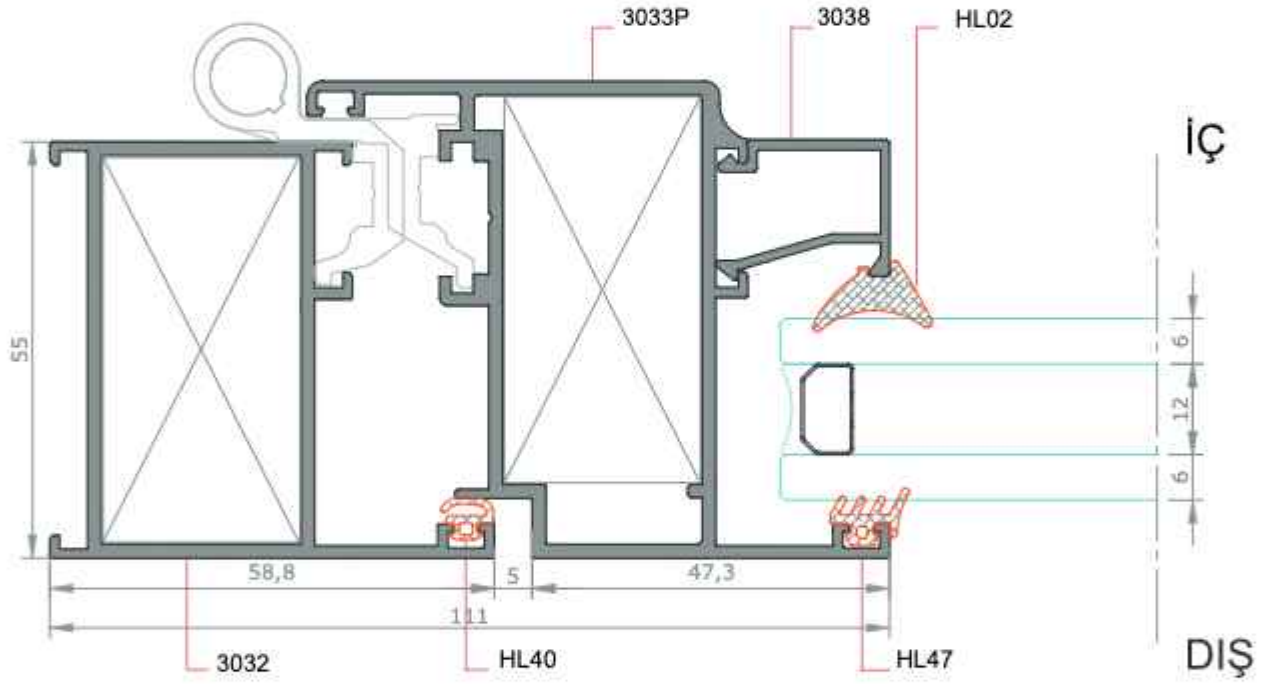
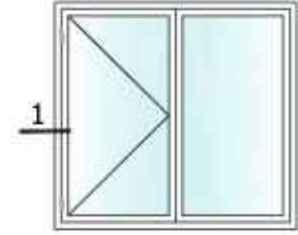

★ Yandaki profil birim ağırlıkları, bilgisayarda hesaplanmış teorik ağırlıklardır.

DETAY-2
ÖLÇEK:1/1

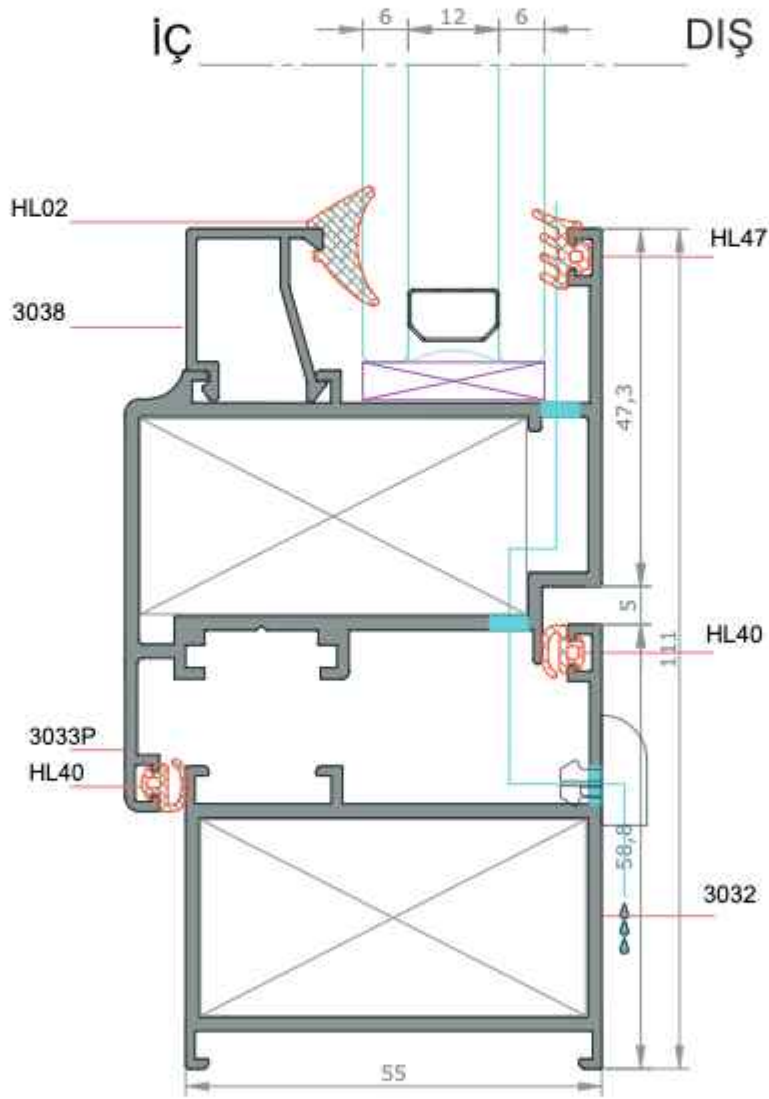
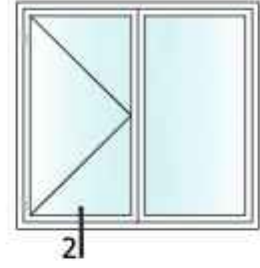

★ Yandaki profil birim ağırlıkları, bilgisayararda hesaplanmış teorik ağırlıklardır.

DETAY-3
ÖLÇEK:1/1

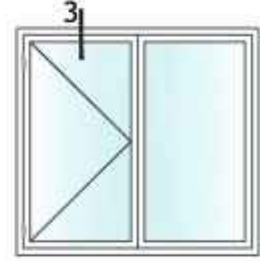

★ Yandaki profil birim ağırlıkları, bilgisayarla hesaplanmış teorik ağırlıklardır.

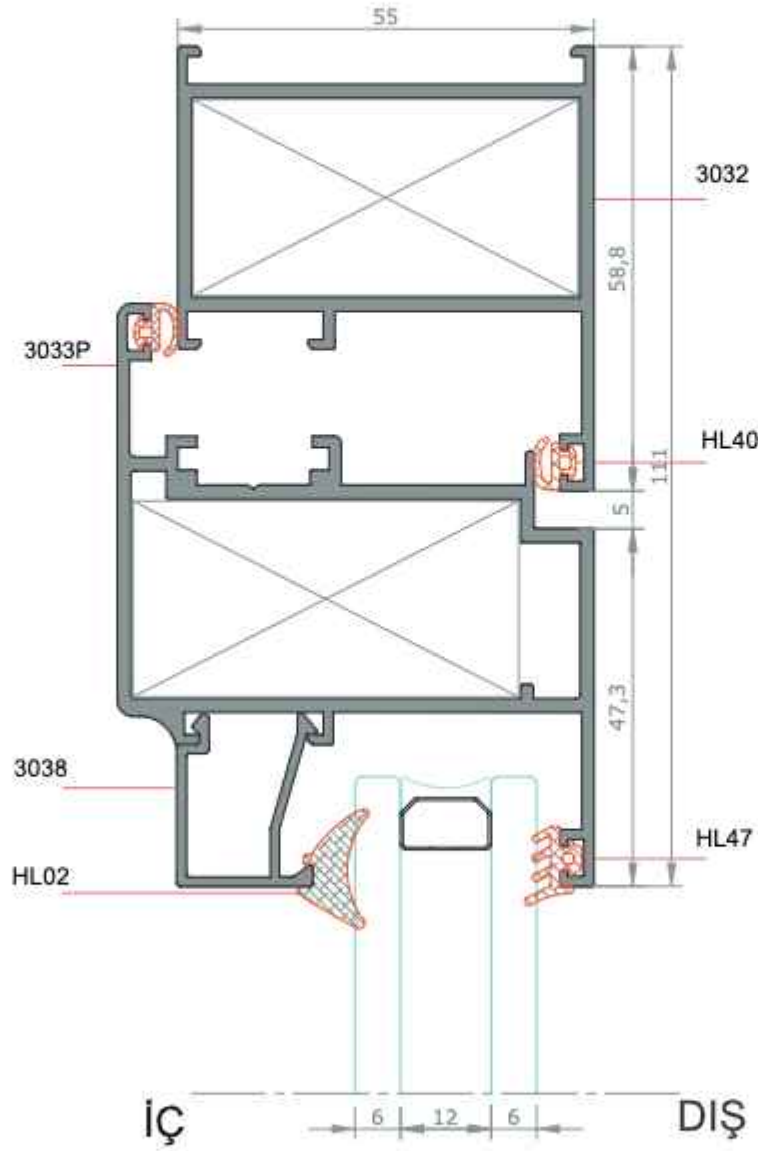

DETAY-4
ÖLÇEK:1/1

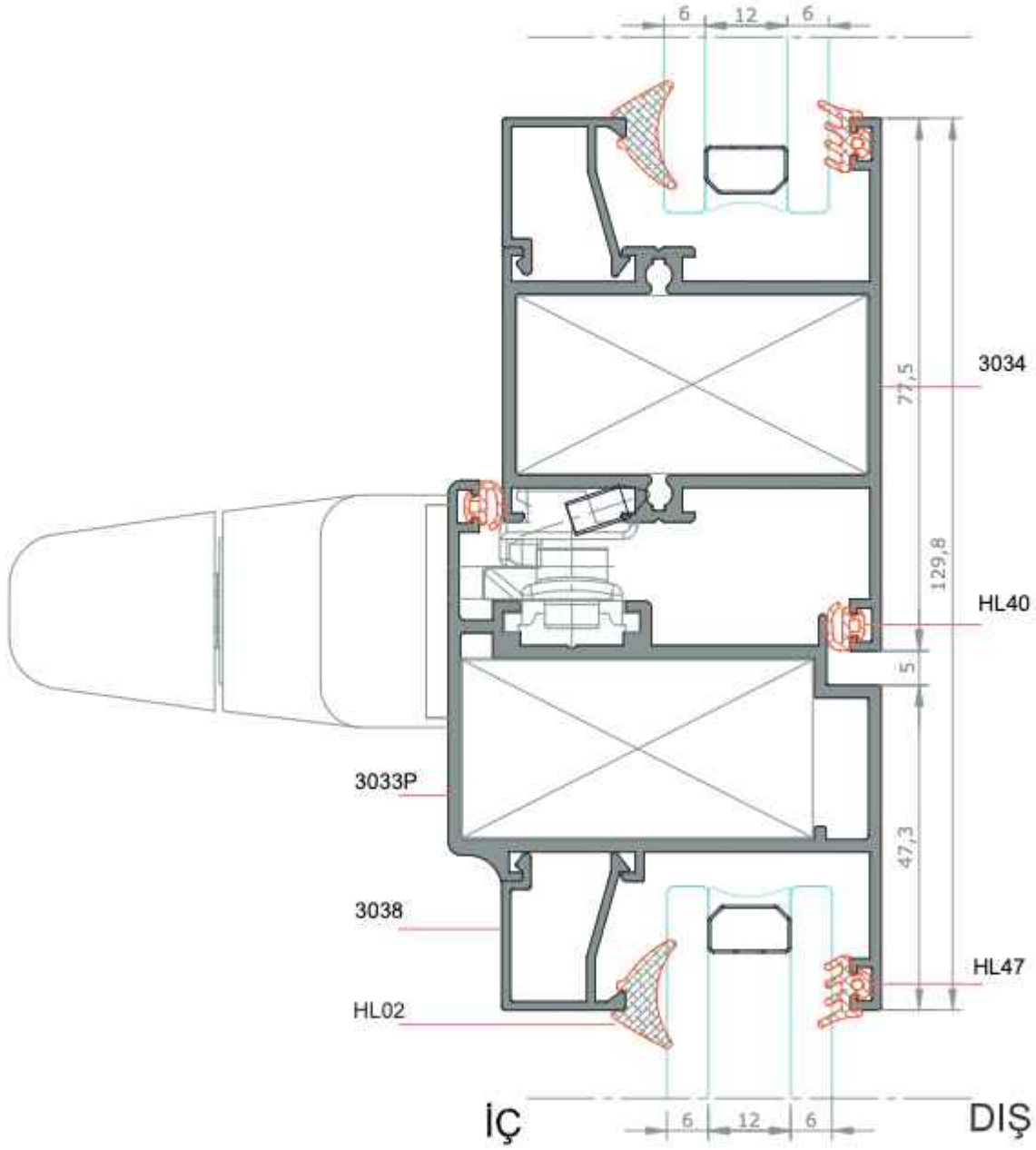
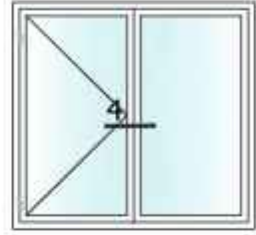

★ Yandaki profil birim ağırlıkları, bilgisayarla hesaplanmış teorik ağırlıklardır.

DETAY-5
ÖLÇEK:1/1

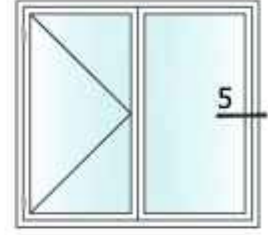

★ Yandaki profil birim ağırlıkları, bilgisayarla hesaplanmış teorik ağırlıklardır.

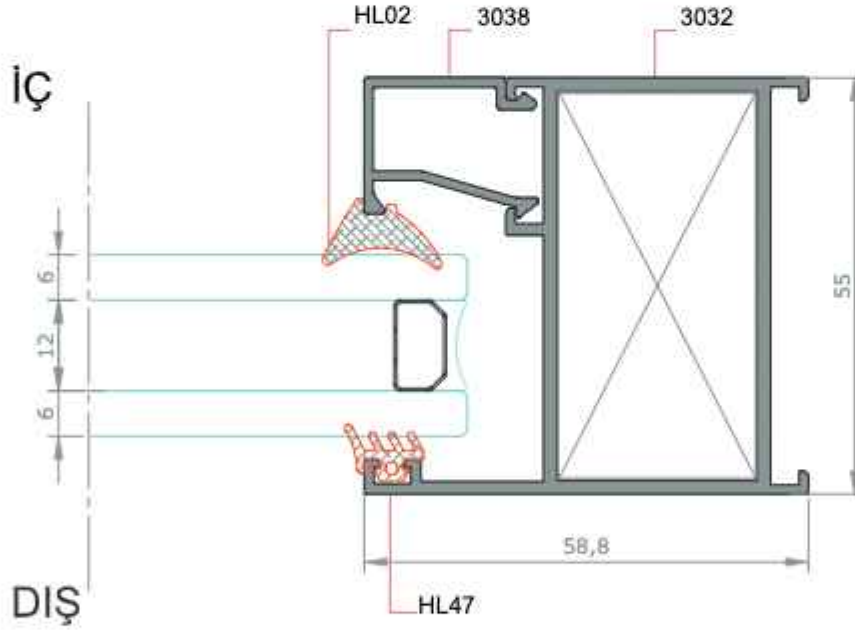

DETAY- 1
ÖLÇEK:1/1

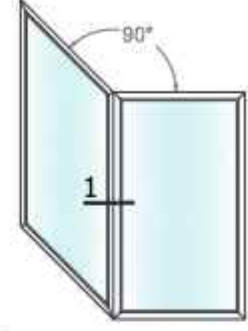

★ Yandaki profil birim ağırlıkları, bilgisayarla hesaplanmış teorik ağırlıklardır.

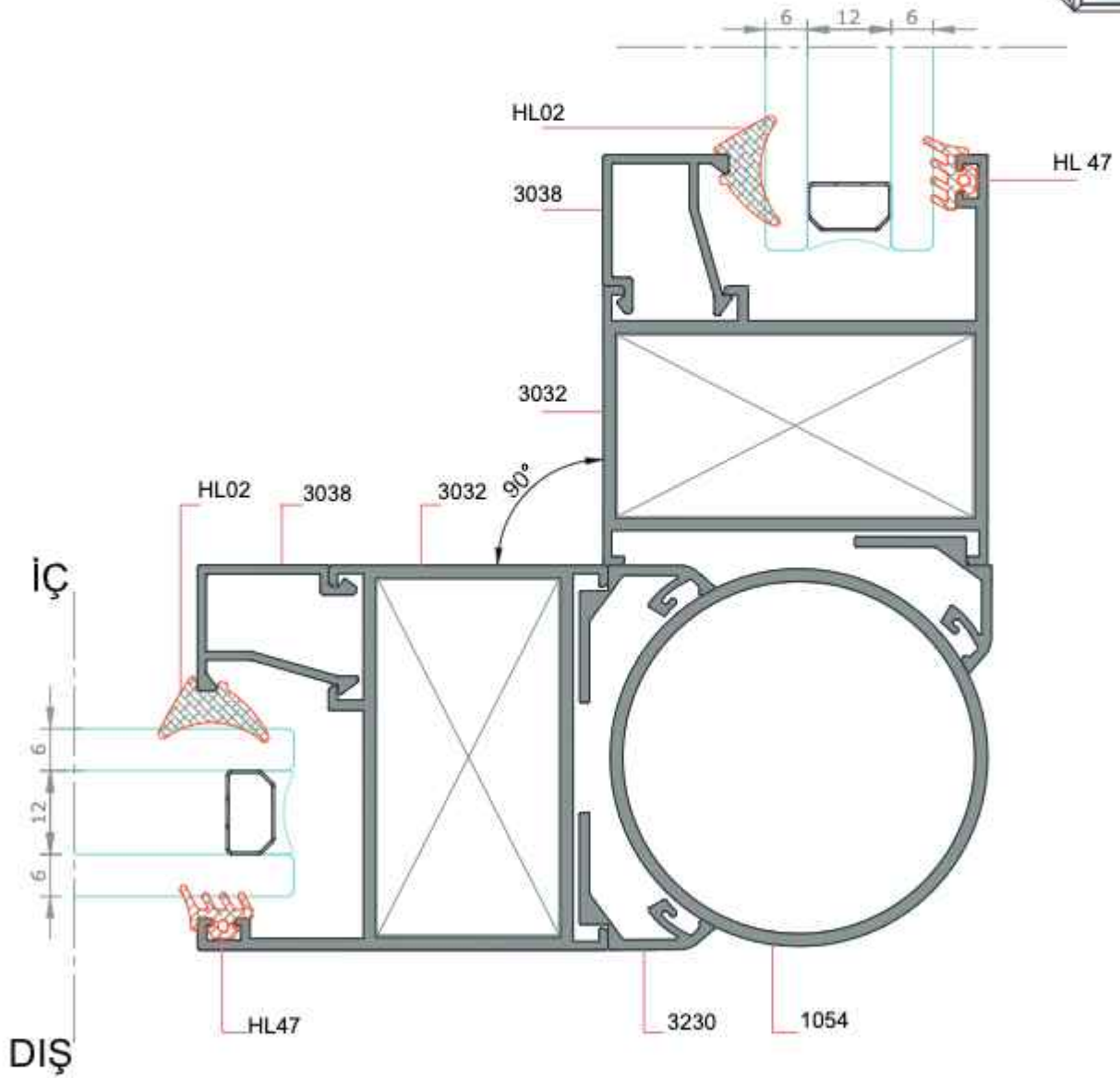

DETAY- 1
ÖLÇEK:1/1

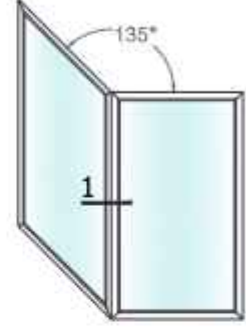

★ Yandaki profil birim ağırlıkları, bilgisayarda hesaplanmış teorik ağırlıklardır.

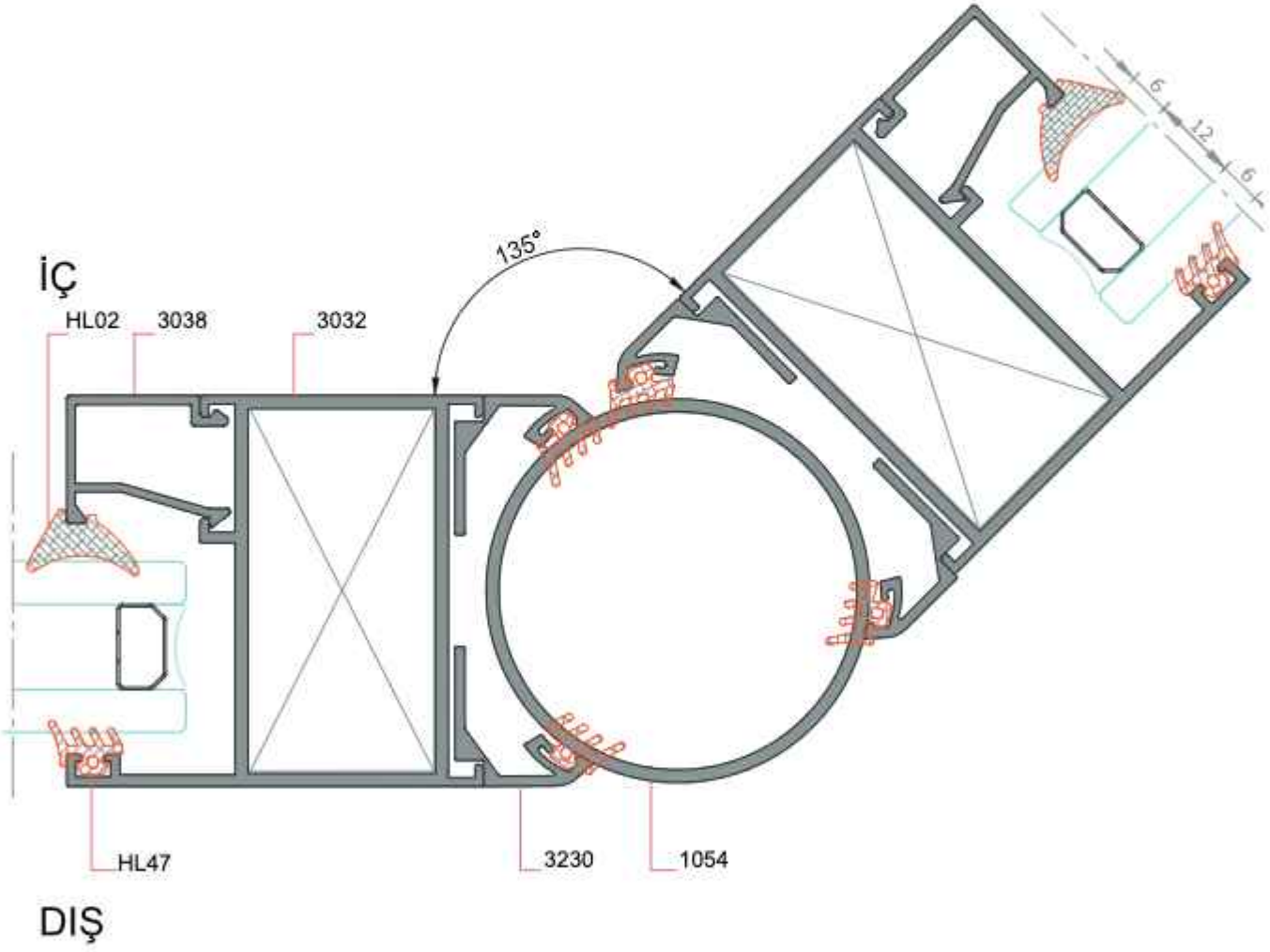

DETAY- 1a
ÖLÇEK:1/1

★ Yandaki profil birim ağırlıkları, bilgisayarla hesaplanmış teorik ağırlıklardır.

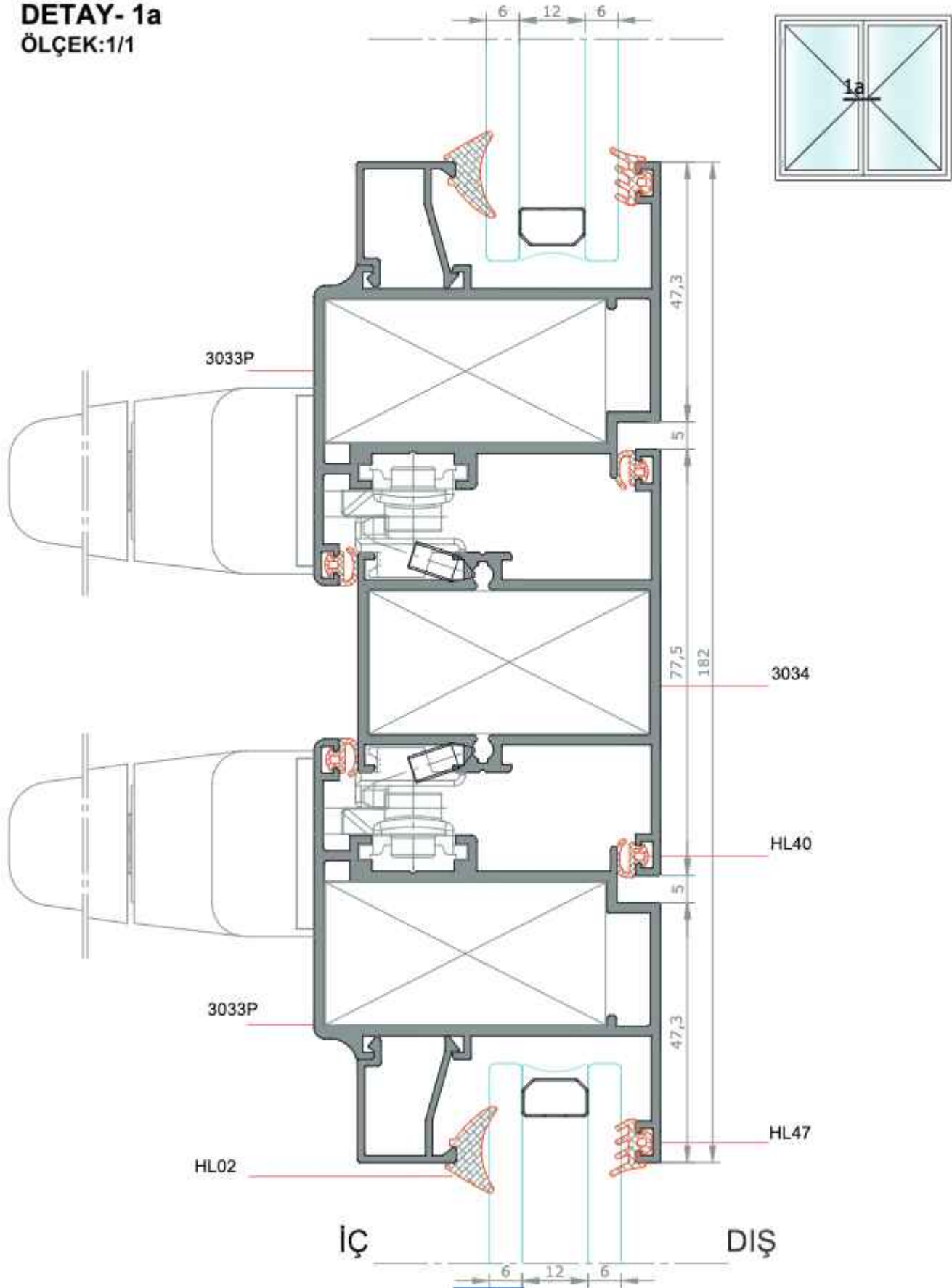

DETAY-1b
ÖLÇEK:1/1

★ Yandaki profil birim ağırlıkları, bilgisayararda hesaplanmış teorik ağırlıklardır.

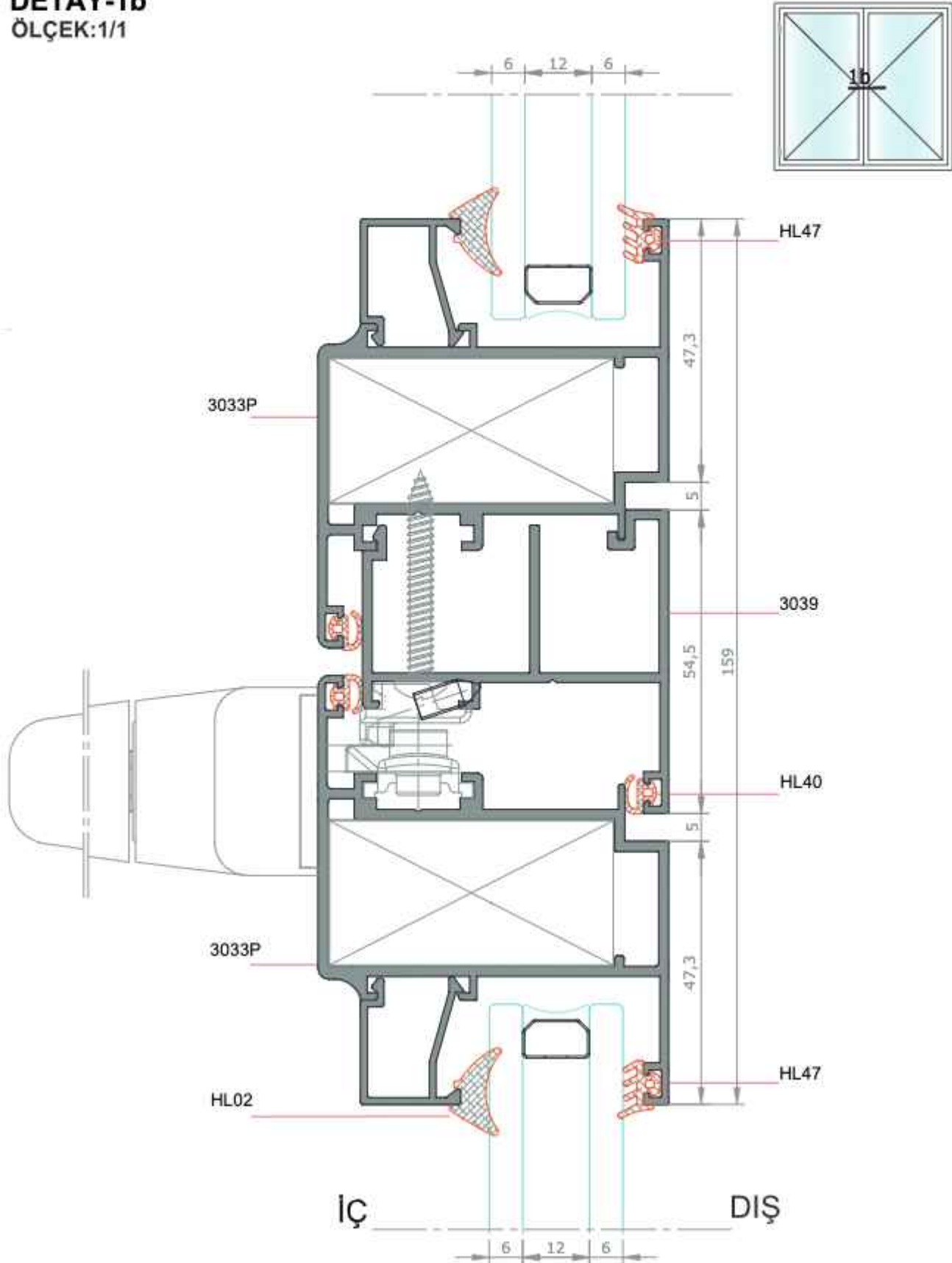

KAPI UYGULAMA TİPLERİ

★ Yandaki profil birim ağırlıkları, bilgisayarla hesaplanmış teorik ağırlıklardır.

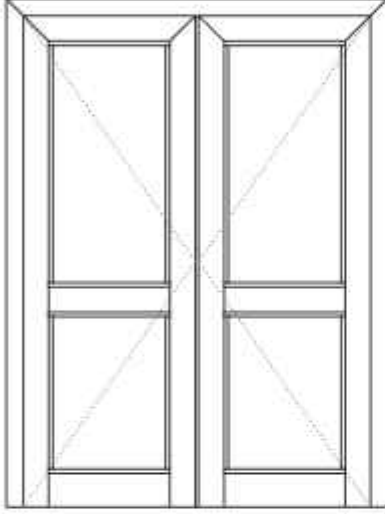

İçe Açılır Kapı

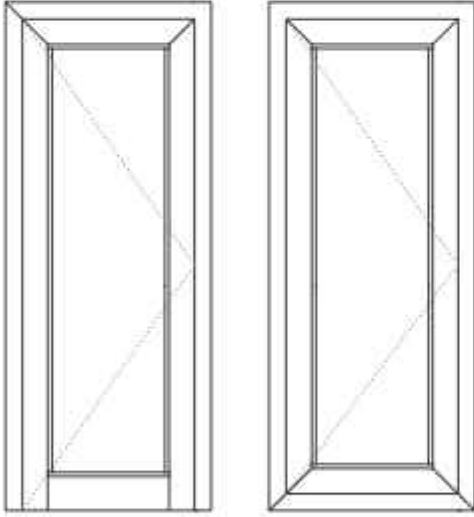

İçe Açılır Kapı

DETAY- 1
ÖLÇEK:1/1

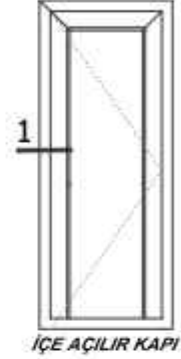

★ Yandaki profil birim ağırlıkları, bilgisayarda hesaplanmış teorik ağırlıklardır.

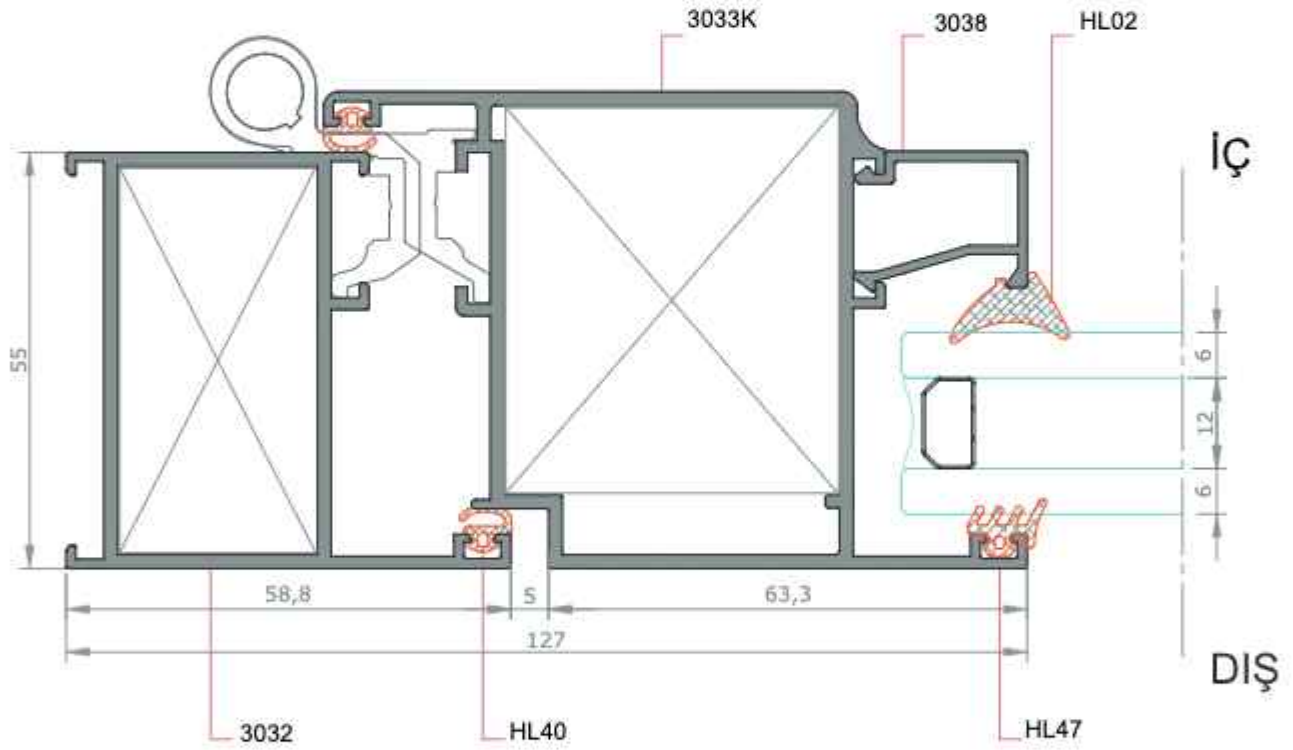

DETAY-2a
ÖLÇEK:1/1

★ Yandaki profil birim ağırlıkları, bilgisayarla hesaplanmış teorik ağırlıklardır.

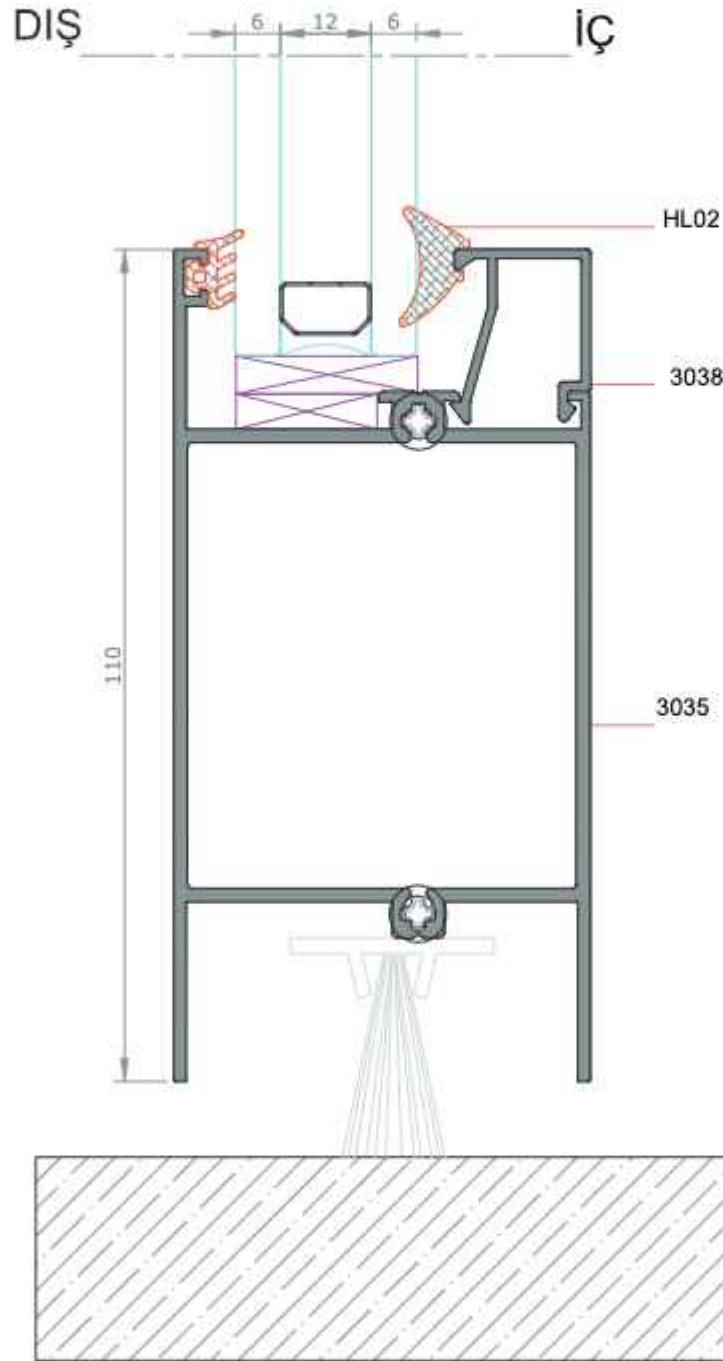

DETAY- 2b
ÖLÇEK:1/1

★ Yandaki profil birim ağırlıkları, bilgisayarla hesaplanmış teorik ağırlıklardır.

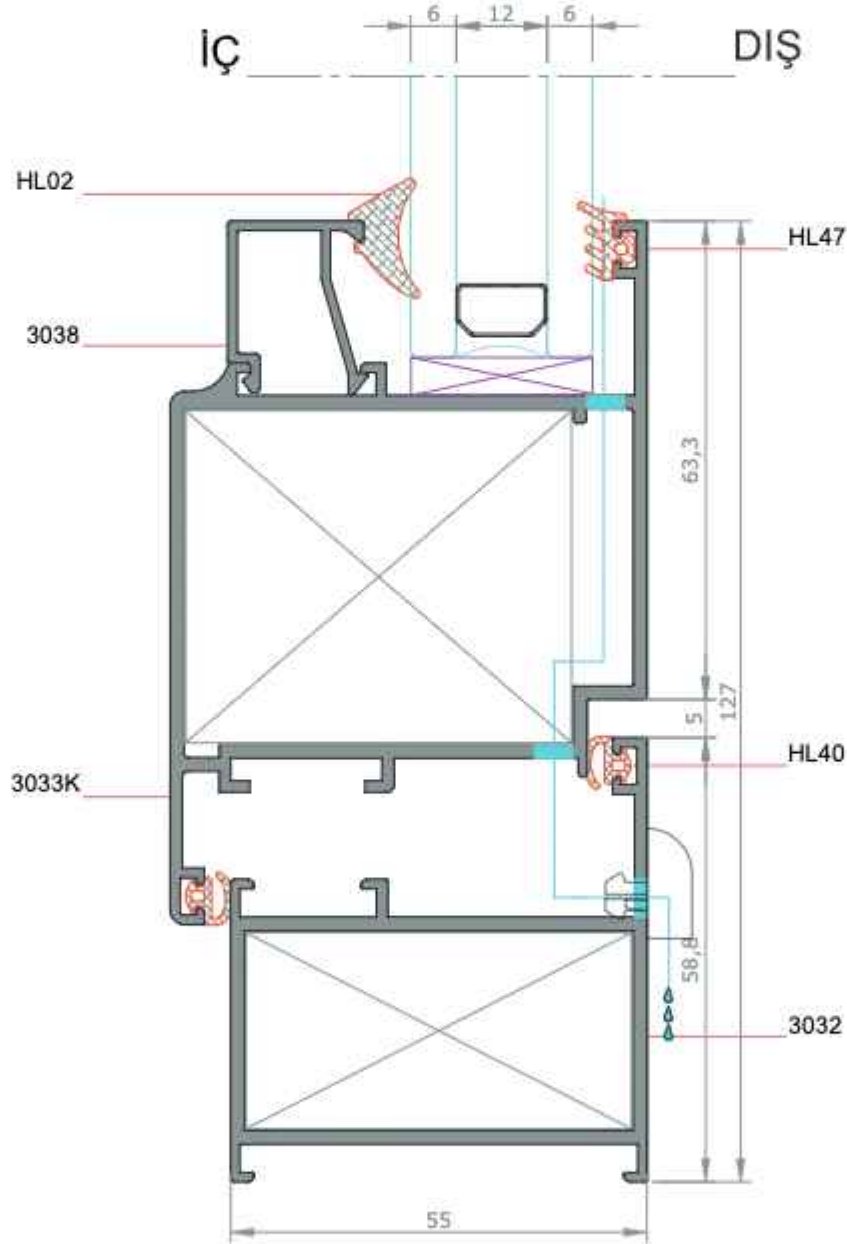

DETAY- 3
ÖLÇEK:1/1

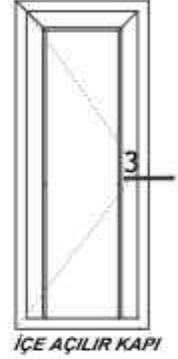

★ Yandaki profil birim ağırlıkları, bilgisayararda hesaplanmış teorik ağırlıklardır.

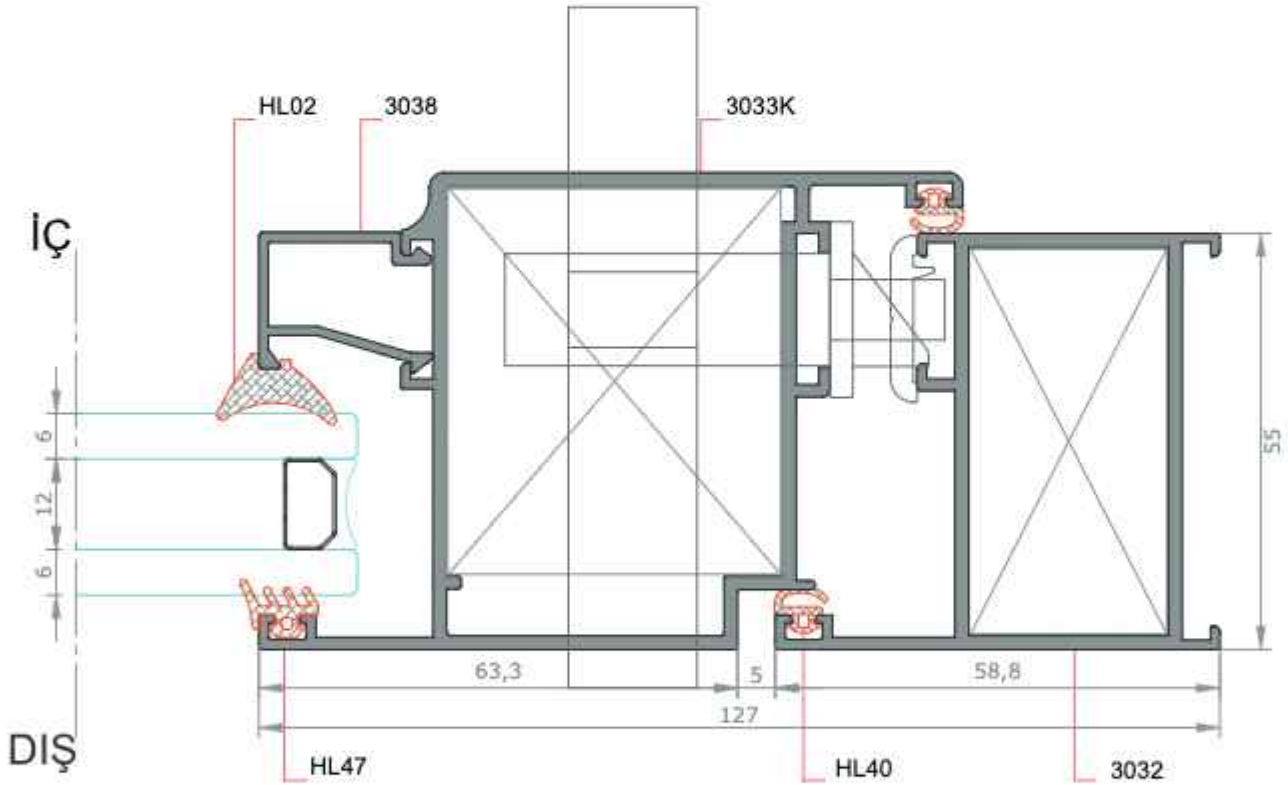

DETAY- 4

ÖLÇEK:1/1

★ Yandaki profil birim ağırlıkları, bilgisayarda hesaplanmış teorik ağırlıklardır.

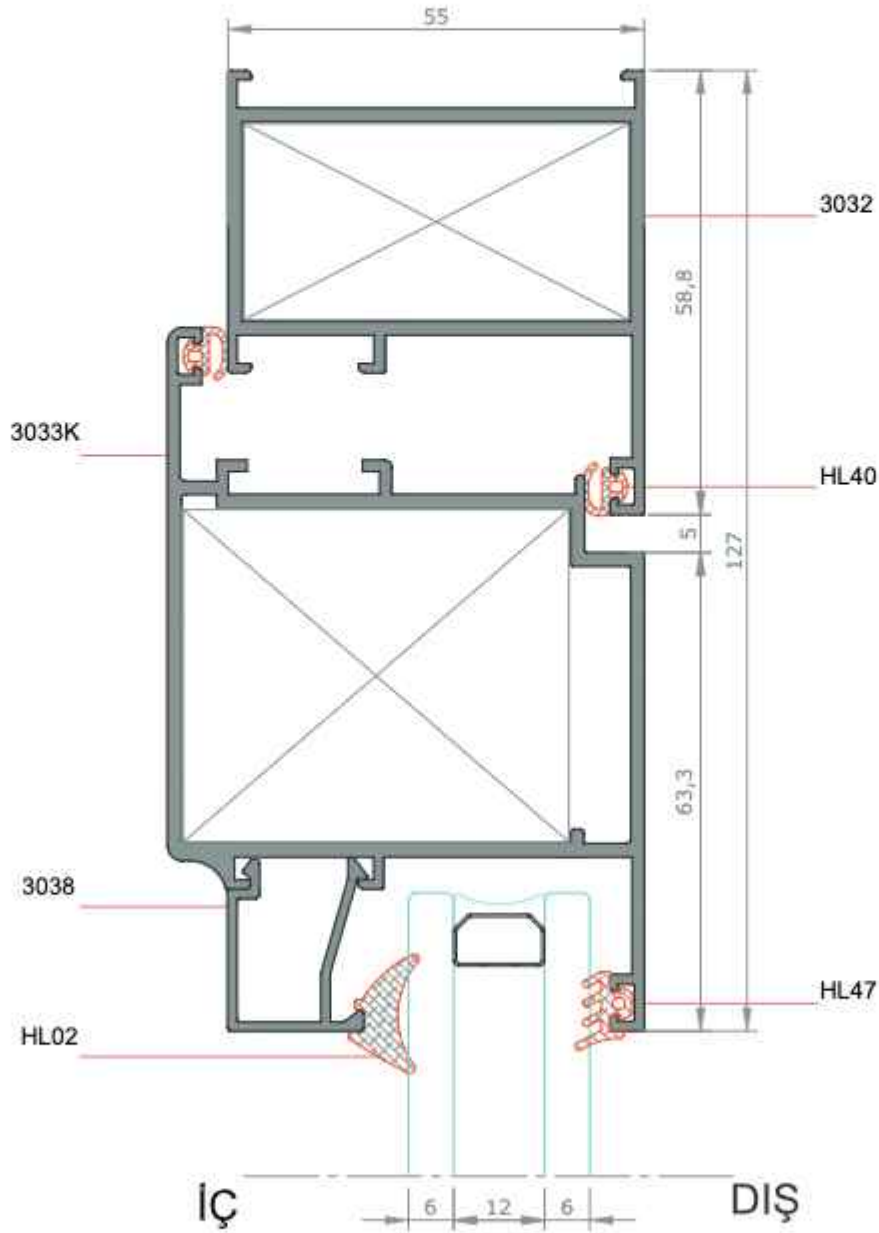

DETAY- 1
ÖLÇEK:1/1

★ Yandaki profil birim ağırlıkları, bilgisayarla hesaplanmış teorik ağırlıklardır.

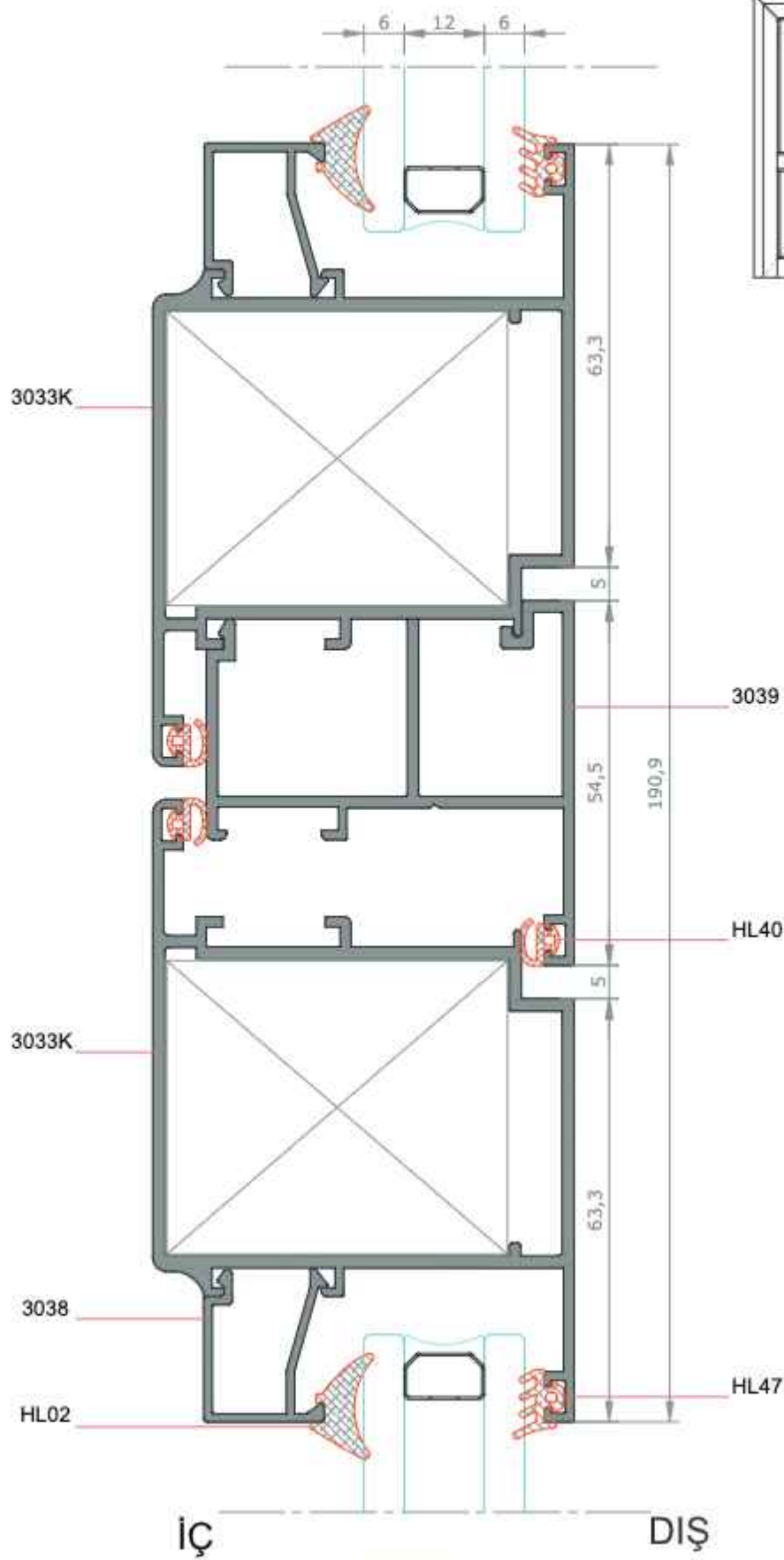

★ Yandaki profil birim ağırlıkları, bilgisayarla hesaplanmış teorik ağırlıklardır.

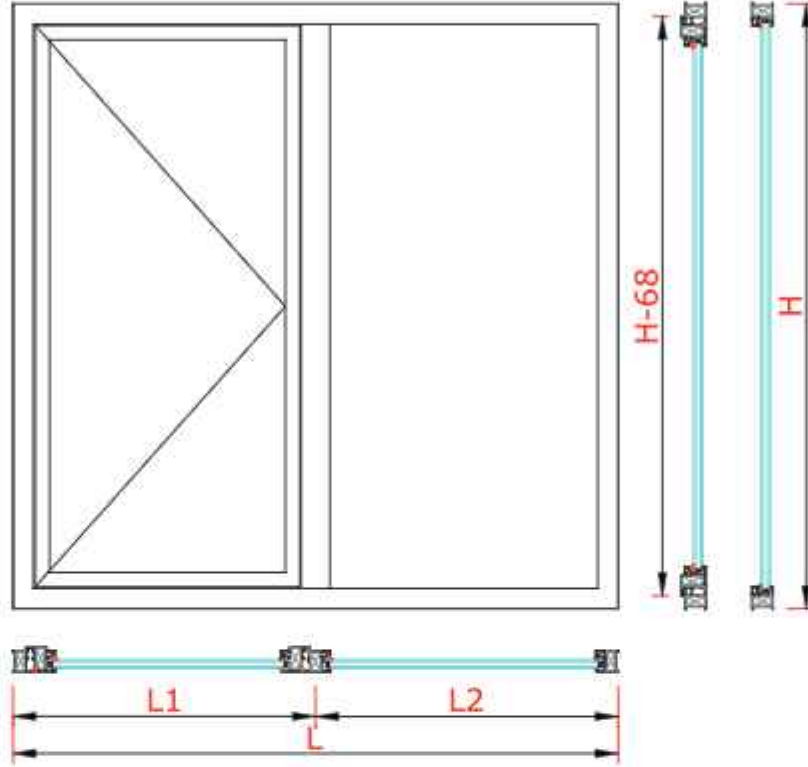

Profilin Adı	Profil Kesiti	Profil Kodu	Adet	Kesim Ölçüsü(mm)	Bağlantı Elemanları	Kod	Birim	Miktar
Kasa Profili		3032	2	L	Köşe Takozu (Kasa)	K3040 509	Adet	4
			2	H	Köşe Takozu (Kanat)	K3040 510	Adet	4
Kanat Profili		3033P	2	L1- 48	Cam (Açılır)		Adet	
			2	H-68	Dış Cam		1	
Orta Kayıt Profili		3034	1	H-70	İç Cam			
Cam Çıtası Profili	Kanat		2		Cam Detayı			
			2					
Cam Çıtası Profili	Kasa Orta Kayıt		3		Cam Detayı			
			1					

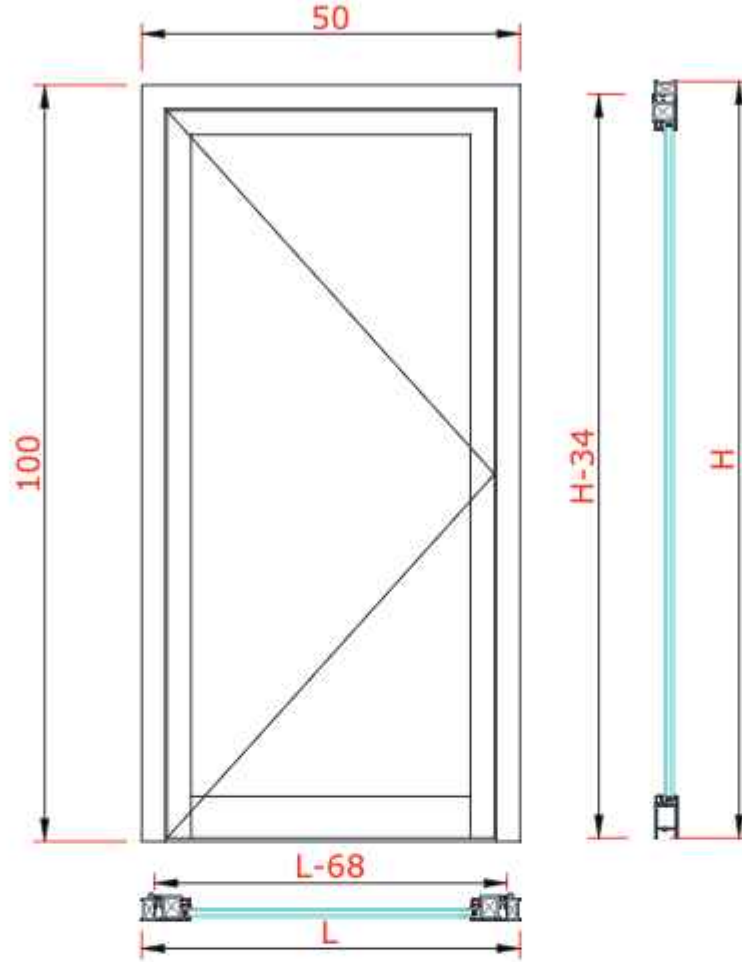

★ Yandaki profil birim ağırlıkları, bilgisayarla hesaplanmış teorik ağırlıklardır.

Profilin Adı	Profil Kesiti	Profil Kodu	Adet	Kesim Ölçüsü(mm)
Kasa Profili		3032	1	L
			2	H
Kanat Profili		3033K	1	L-68
			2	H-34
Etek Profili		3035	1	L-208
Cam Çıtası Profili	Kanat		2	
			2	

Bağlantı Elemanları	Kod	Birim	Miktar
Köşe Takozu (Kasa)	K3040 509	Adet	2
Köşe Takozu (Kanat)	K3041 510	Adet	2

Cam (Açılır)	Adet	Cam Detayı	Kesim Ölçüsü (mm)
Dış Cam	1		
İç Cam			



PROFİL KATALOĐU









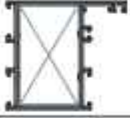
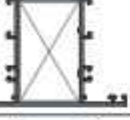

GXY H57 ISI YALITIMSIZ KAPI VE PENCERE SİSTEMLERİ

*GXY H57 THERMAL UNINSULATED DOOR &
WINDOW SYSTEMS*

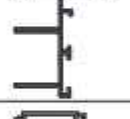
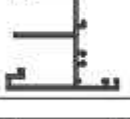
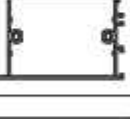
* Profil Ađırlıkları Teorik Olup Teslim Anındaki Ađırlık Geerlidir

* *Weight of profiles are theoretical, net weight will valid at the time of delivery.*

★ Yandaki profil birim ağırlıkları, bilgisayarda hesaplanmış teorik ağırlıklardır.

PROFİL KESİTİ	PROFİL KODU	PROFİL ADI	AĞIRLIK	ATALET MOMENTLERİ		SAYFA NO
				J_x (cm ⁴)	J_y (cm ⁴)	
	2363	Kasa Profili	1,125 kg/m	20,69	11,95	
	2362	Orta Kayıt Profili	1,253 kg/m	21,29	18,98	
	2327	Orta Kayıt Profili	1,140 kg/m	19,29	17,0	
	2364	Kanat Profili	1,313 kg/m	34,95	12,93	
	2365	Kanat Profili	1,490 kg/m	50,52	24,73	
	2791	Dışa Açılır Kanat Profili	1,444 kg/m	29,21	17,56	
	2790	Adaptör	0,787 kg/m	31,3	11,52	
	2493	Adaptör	1,054 kg/m	17,28	9,43	
	2494	Etek Profili	1,848 kg/m	85,0	34,13	
	2344	Etek Profili	1,513 kg/m	74,27	31,22	
	1093	Tahta Lambiri	0,572 kg/m	15,0	0,41	
	1256	Düz Lambiri	0,342 kg/m	9,73	0,4	
	1472	Düz Lambiri	0,397 kg/m	10,99	0,2	
	1225	Tır Lambirisi	1,191 kg/m	51,78	4,92	

★ Yandaki profil birim ağırlıkları, bilgisayarda hesaplanmış teorik ağırlıklardır.

PROFİL KESİTİ	PROFİL KODU	PROFİL ADI	AĞIRLIK	ATALET MOMENTLERİ		SAYFA NO
				J_x (cm ⁴)	J_y (cm ⁴)	
	50199	Düz Lambiri	0,759 kg/m	
	2792	Cam Çıtası	0,312 kg/m	
	2328	Cam Çıtası	0,250 kg/m	
	2793	Cam Çıtası	0,358 kg/m	
	2329	Cam Çıtası	0,286 kg/m	
	1210	İspanyolet Çubuğu	0,112 kg/m	
	2181	Damlalık Profili	0,168 kg/m	
	1538	Köşe Takoza	3,611 kg/m	
	1948	Köşe Takoza	1,240 kg/m	
	2342	Köşe Takoza	4,442 kg/m	
	2343	U Bağlantı Profili	0,544 kg/m	

★ Yandaki profil birim ağırlıkları, bilgisayarda hesaplanmış teorik ağırlıklardır.

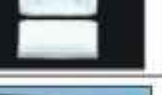
AKSESUAR KESİTİ	AKSESUAR KODU	AKSESUAR ADI	AĞIRLIK	PAKETLEME	SAYFA NO
	HL31	Kama Fiteli - 2 mm	39 gr/m	15 kg/ 375 m	
	HL04	Kama Fiteli - 3 mm	60 gr/m	15 kg/ 250 m	
	HL07	Kama Fiteli - 4 mm	63 gr/m	15 kg/ 238 m	
	HL06	Dış Cam Fiteli	51 gr/m	15 kg/ 294 m	
	HL32	Dış Cam Fiteli	43 gr/m	15 kg/ 326m	
	HL96	Kasa Kanat Basma Fiteli	25 gr/m	15 kg/ 600m	
	HL05	Bini Fiteli	46 gr/m	15 kg/ 319m	
	HL95	Orta Bini Fiteli	85 gr/m	15 kg/ 176m	
	MP-56-04/3-1	Köşe Gönye	...	200 Ad/ Paket	
	MP26-05	Su Tahliye Tapası	...	2000 Ad/ Paket	
	MP33-04/3	Y Kapı Alt Fırçası	...	100 Ad/ Paket	
	MP56-07/5H	Seri Sistem Mentеше	...	200 Ad/ Paket	
	MP31-02/09-1	Paslanmaz Tek Büküm Oval Yale Kol	...	30 Ad/ Paket	
	MP31-11	Boru Kol	...	10 Ad/ Paket	

★ Yandaki profil ağırlıkları, bilgisayarda hesaplanmış teorik ağırlıklardır.

AKSESUAR KESİTİ	AKSESUAR KODU	AKSESUAR ADI	AĞIRLIK	PAKETLEME	SAYFA NO
	MP31-01	Yaylı Sosis Kol	...	50 Ad/ Paket	
	MP31-09/13	Yaylı Dar Aynalı Sosis Kol	...	30 Ad/ Paket	
	MP31-07/2Y	Yaylı Düz Rozetli Sosis Kol	...	50 Ad/ Paket	
	MP31-24/2H	Akbank Havuzlu Kol Aparatı	...	30 Ad/ Paket	
	MP31-24/20	Akbank 40'lık Kol Aparatı	...	30 Ad/ Paket	
	MP34-01/4/9	90 mm Barel	...	24 Ad/ Paket	
	MP34-04/5	Dilli Kilit (153-35)	...	30 Ad/ Paket	
	MP34-02/7	Makaralı Kilit (155-35)	...	30 Ad/ Paket	
	MP33-12	Isı yalıtımlı Uzun Sürgü	...	100 Ad/ Paket	
	MP56-01/6/3-1	Dilli Kilit Karşılığı	...	50 Ad/ Paket	
	MP56-01/6/6	Makaralı Kilit Karşılığı	...	50 Ad/ Paket	
	MP32-34/3	İspanyolet Pim Takımı	...	100 Tk/ Paket	

★ Yandaki profil birim ağırlıkları, bilgisayarda hesaplanmış teorik ağırlıklardır.

AKSESUAR KESİTİ	AKSESUAR KODU	AKSESUAR ADI	AĞIRLIK	PAKETLEME	SAYFA NO
	MP33-09/4-3	Vasistas Makası	...	100 Ad/ Paket	
	MP33-15/5	Cico Avrupa Vasistas Çıtçıt	...	50 Ad/ Paket	
	MP32-33/1	Ayarlı Karşılık	...	500 Ad/ Paket	
	TS 71	Kapi Hidroliği	...	10 Ad/ Paket	
	MP33-04/2	Kapi Altı Fırçası	...	100 Ad/ Paket	
	HE-9991	Pvc Tij	...	200 m/ Paket	
	MP-9998	Kesme ve Delme Makinası	...	1 Ad/ Paket	

★ Yandaki profil birim ağırlıkları, bilgisayarla hesaplanmış teorik ağırlıklardır.

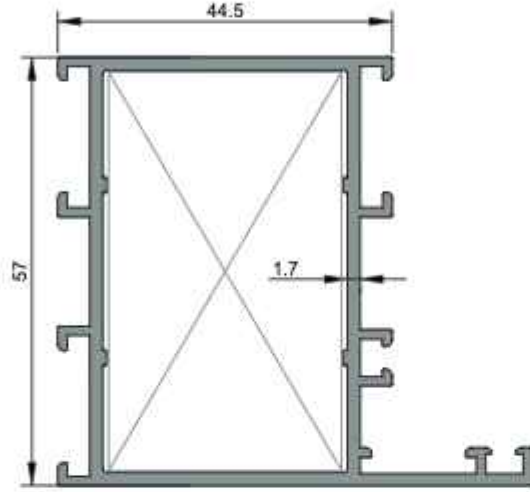

2363
Kasa Profili
1,125 kg/m
$J_x=20,69 \text{ cm}^4$ $J_y=11,95 \text{ cm}^4$

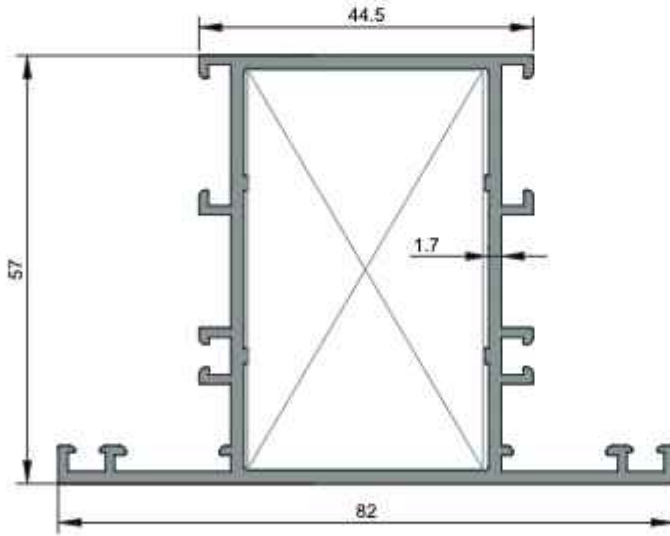

2362
Orta Kayıt Profili
1,253 kg/m
$J_x=21,29 \text{ cm}^4$ $J_y=18,98 \text{ cm}^4$

★ Yandaki profil birim ağırlıkları, bilgisayarla hesaplanmış teorik ağırlıklardır.

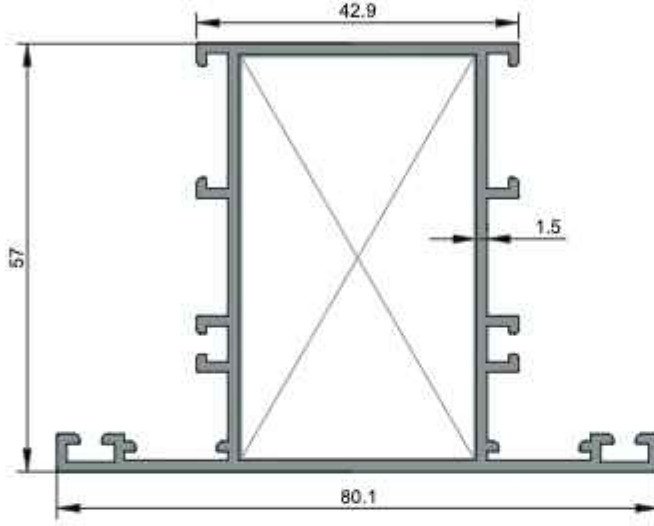

2327
Orta Kayıt Profili
1,140 kg/m
Jx=19,29 cm ⁴ Jy=17,0 cm ⁴

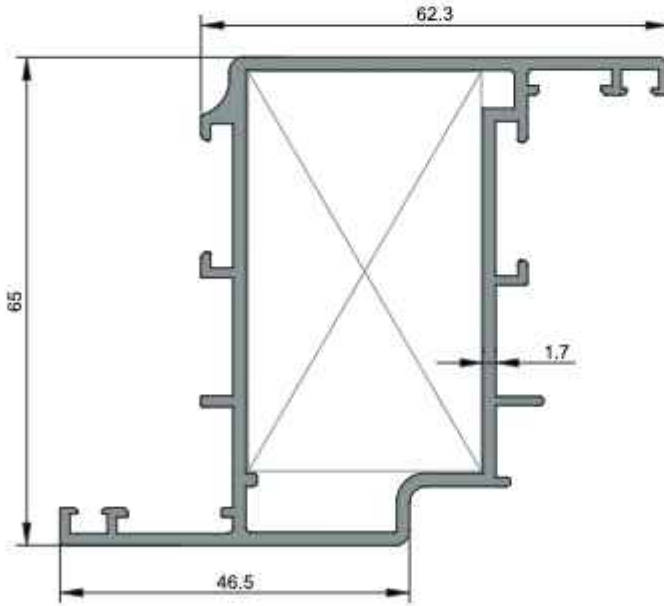

2364
Kanat Profili
1,308 kg/m
Jx=34,92 cm ⁴ Jy=12,77 cm ⁴

★ Yandaki profil birim ağırlıkları, bilgisayarda hesaplanmış teorik ağırlıklardır.

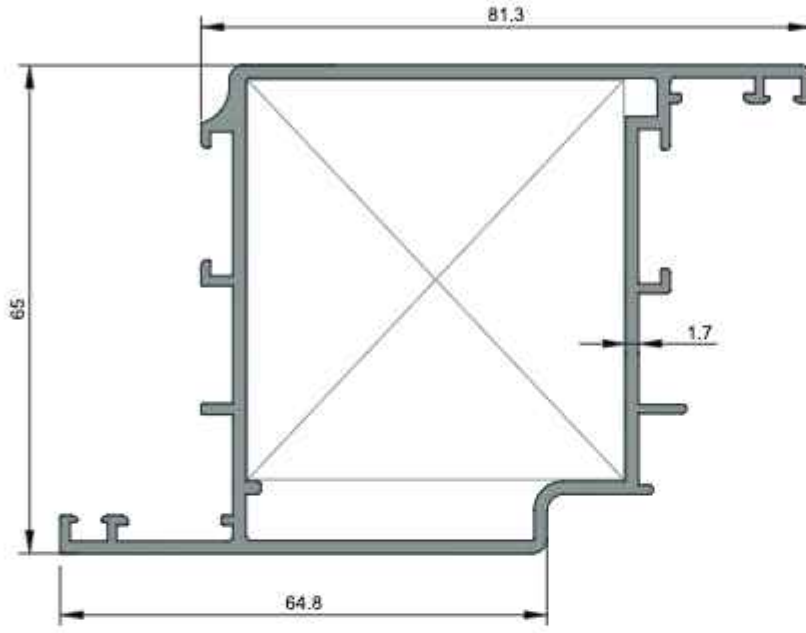

2365
Kanat Profili
1,485 kg/m
Jx=50,51 cm ⁴ Jy=24,47 cm ⁴

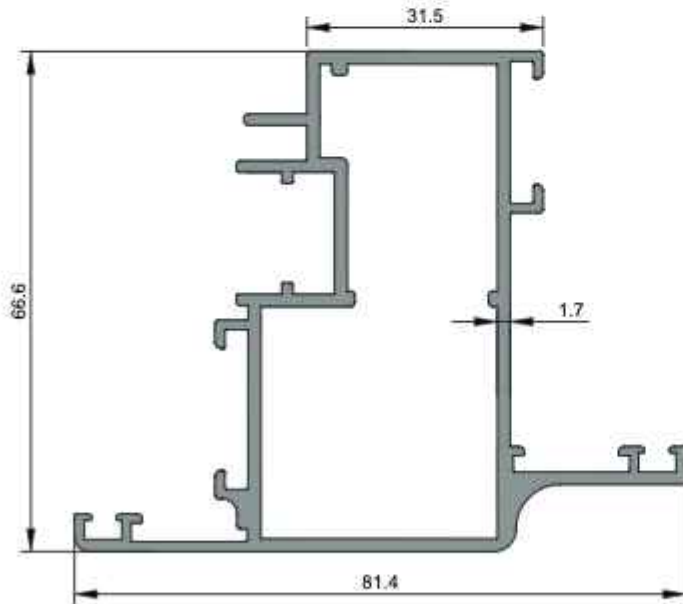

2791
Dışa Açılır Kanat Profili
1,444 kg/m
Jx=29,21 cm ⁴ Jy=17,56 cm ⁴

★ Yandaki profil birim ağırlıkları, bilgisayarda hesaplanmış teorik ağırlıklardır.

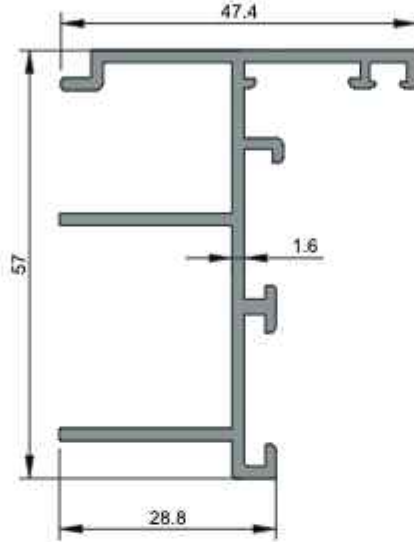

2790
Dışa Açılır Kanat Adaptör Profili
0,787 kg/m
Jx=31,3 cm ⁴ Jy=11,52 cm ⁴

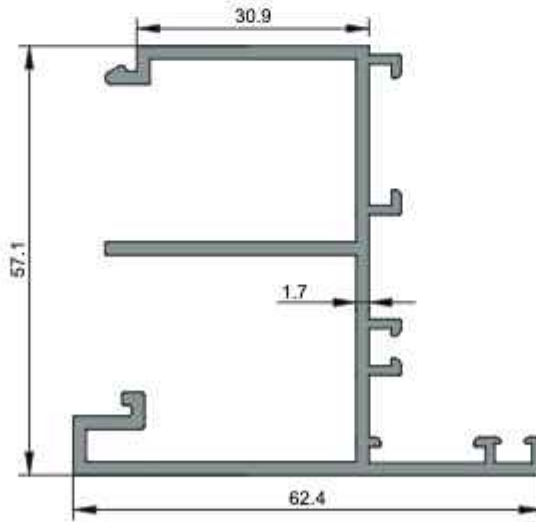

2493
Çift Kanat Adaptör Profili
1,054 kg/m
Jx=17,28 cm ⁴ Jy=9,43 cm ⁴

★ Yandaki profil birim ağırlıkları, bilgisayarda hesaplanmış teorik ağırlıklardır.

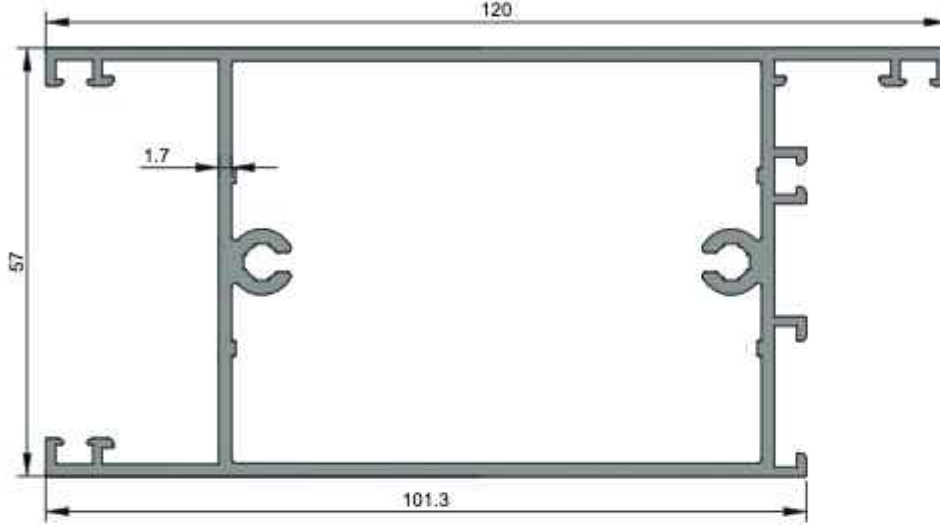

2494
Etek Profili
1,848 kg/m
Jx=85,0 cm ⁴ Jy=34,13 cm ⁴

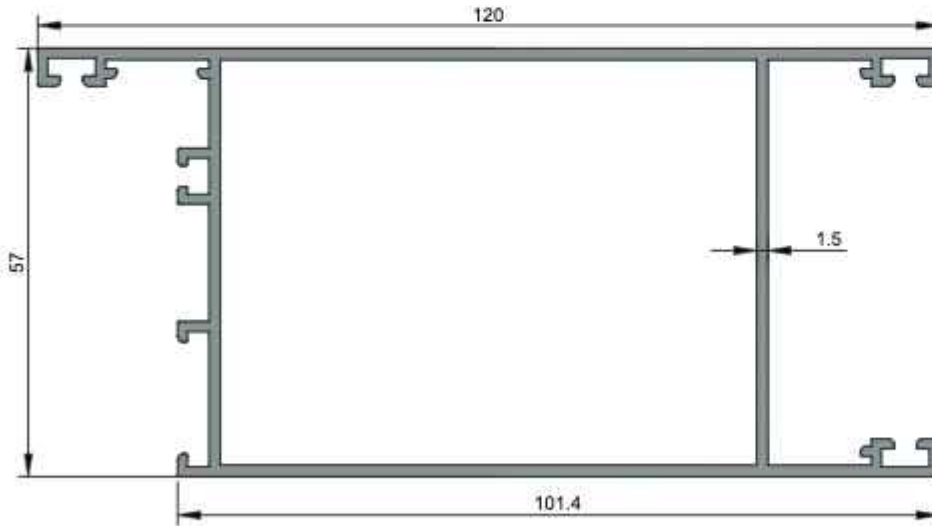

2344
Etek Profili
1,513 kg/m
Jx=74,27 cm ⁴ Jy=31,22 cm ⁴

★ Yandaki profil birim ağırlıkları, bilgisayarda hesaplanmış teorik ağırlıklardır.

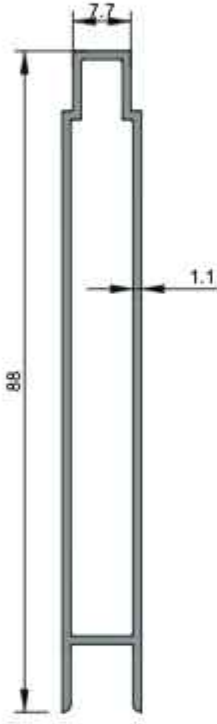

1093
Tahta Lambiri Profili
0,572 kg/m

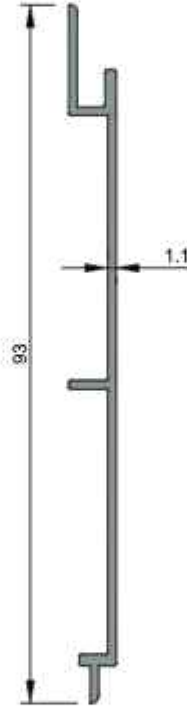

1256
Düz Lambiri Profili
0,342 kg/m



1472
Düz Lambiri Profili
0,397 kg/m

★ Yandaki profil birim ağırlıkları, bilgisayarda hesaplanmış teorik ağırlıklardır.

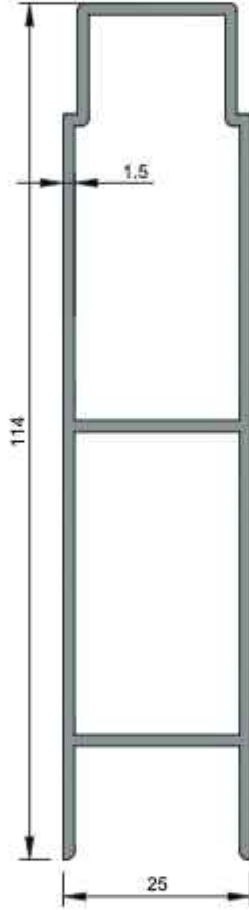

1225
Lambiri Profili
1,191 kg/m

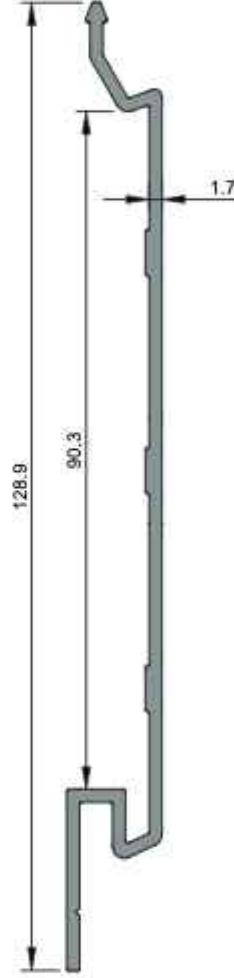

50199
Düz Lambiri Profili
0,759 kg/m

★ Yandaki profil birim ağırlıkları, bilgisayarda hesaplanmış teorik ağırlıklardır.

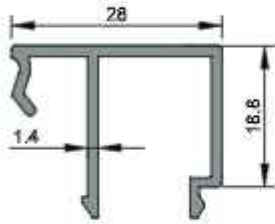

2792
Cam Çıtası
0,312 kg/m

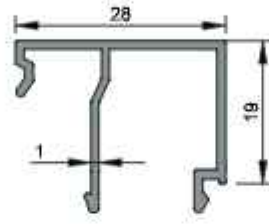

2328
Cam Çıtası
0,250 kg/m

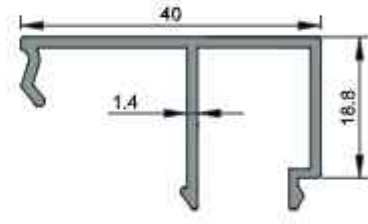

2793
Cam Çıtası
0,358 kg/m

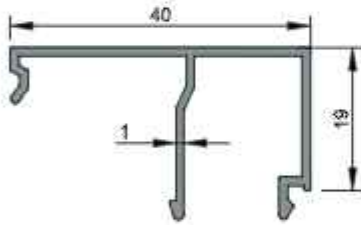

2329
Cam Çıtası
0,286 kg/m

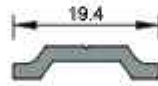

1210
İspanyolek Çubuğu
0,112 kg/m

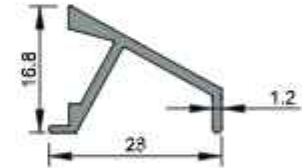

2181
Damlalık Profili
0,168 kg/m

KÖŞE TAKOZU KESİM ÖLÇÜLERİ

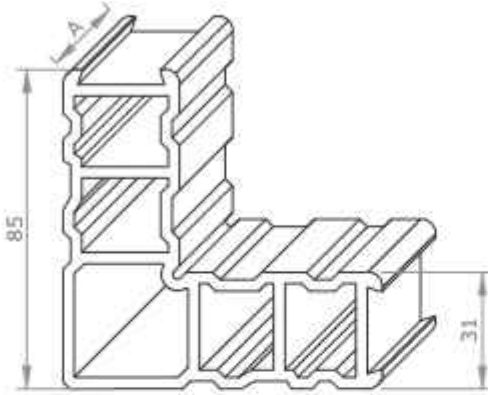

1538

Köşe Takozu

3,611 kg/m

Aksesuar Kodu	Profil Kodu	Kesim Ölçüsü A(mm)
K1538 531	2363	53.1
K1538 531	2362	53.1
K1538 535	2327	53.5
K1538 532	2364	53.2

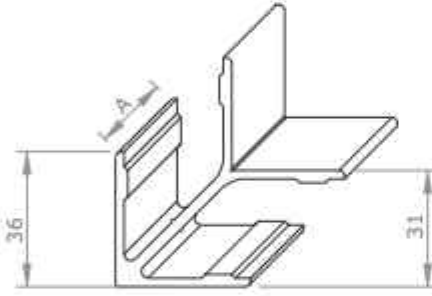

1948

Köşe Takozu

1,240 kg/m

Aksesuar Kodu	Profil Kodu	Kesim Ölçüsü A(mm)
K1948 531	2363	53.1
K1948 531	2362	53.1
K1948 535	2327	53.5
K1948 532	2364	53.2

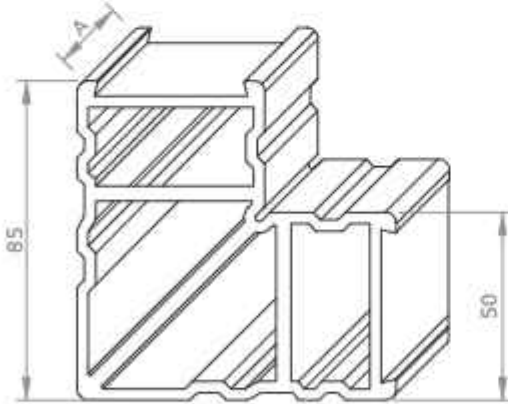

2342

Köşe Takozu

4,442 kg/m

Aksesuar Kodu	Profil Kodu	Kesim Ölçüsü A(mm)
K2342 532	2365	53.2

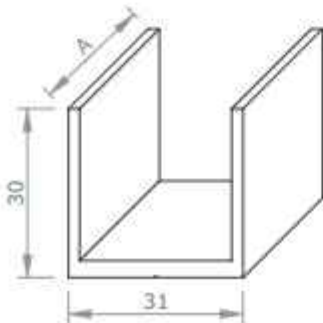

2343

U Bağlantı

0,544 kg/m

Aksesuar Kodu	Profil Kodu	Kesim Ölçüsü A(mm)
U2343 535	2327	53.5

★ Yandaki profil birim ağırlıkları, bilgisayarda hesaplanmış teorik ağırlıklardır.

★ Yandaki profil birim ağırlıkları, bilgisayarda hesaplanmış teorik ağırlıklardır.

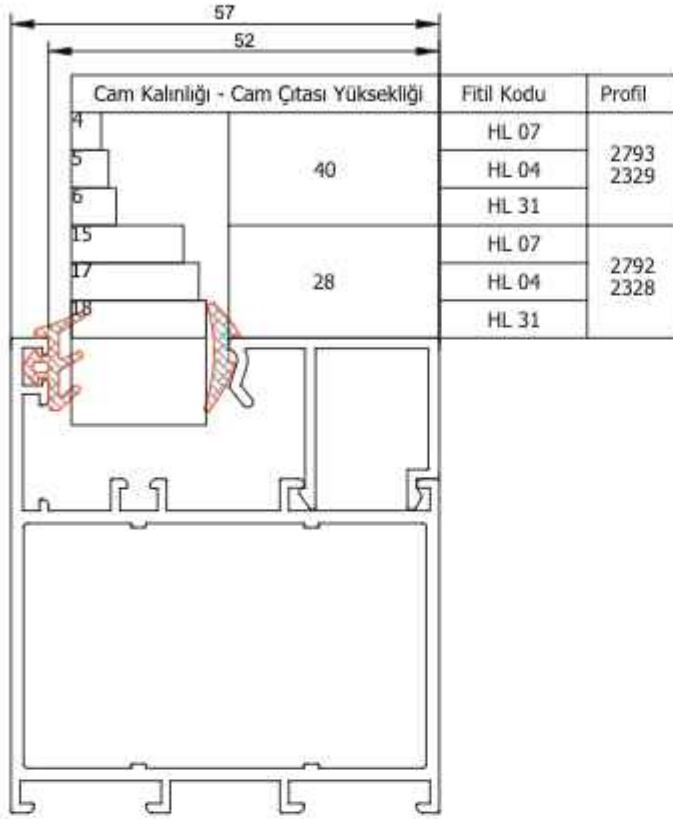

CAMLAMA SEÇENEK TABLOSU

ÖLÇEK:1/1

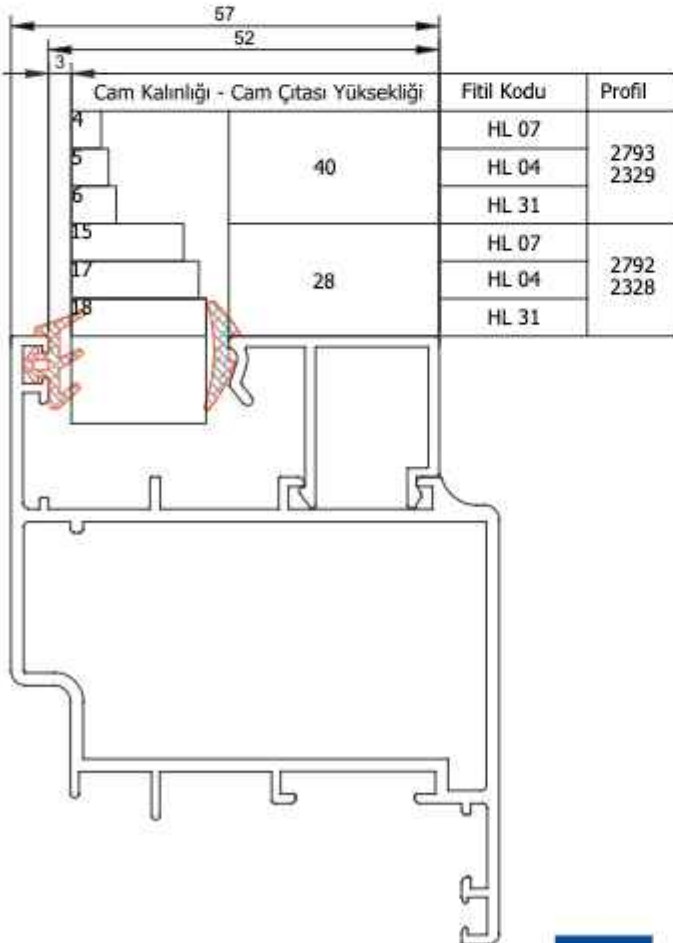
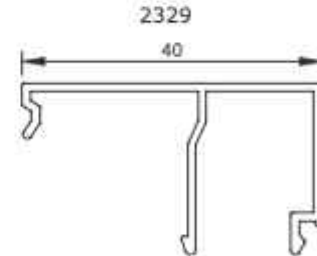
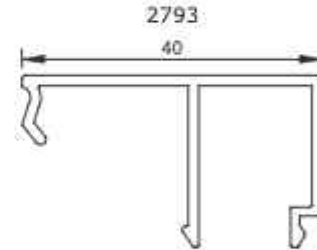
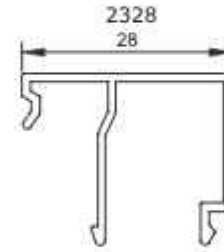
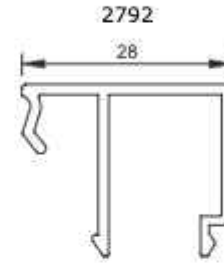

PENCERE UYGULAMA TİPLERİ

★ Yandaki profil birim ağırlıkları, bilgisayarda hesaplanmış teorik ağırlıklardır.

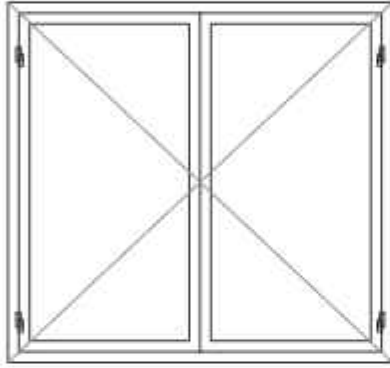

İçe Açılır Pencere

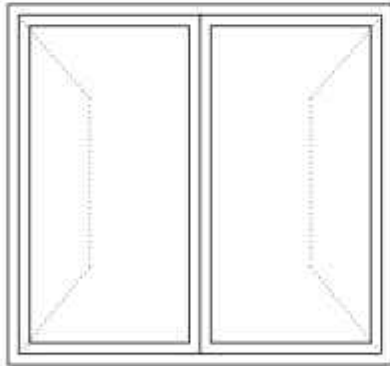
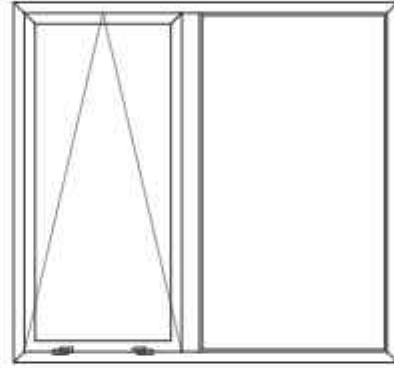

Dışa Açılır Pencere

DETAY-1
ÖLÇEK:1/1

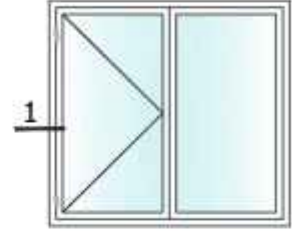

★ Yandaki profil birim ağırlıkları, bilgisayarla hesaplanmış teorik ağırlıklardır.

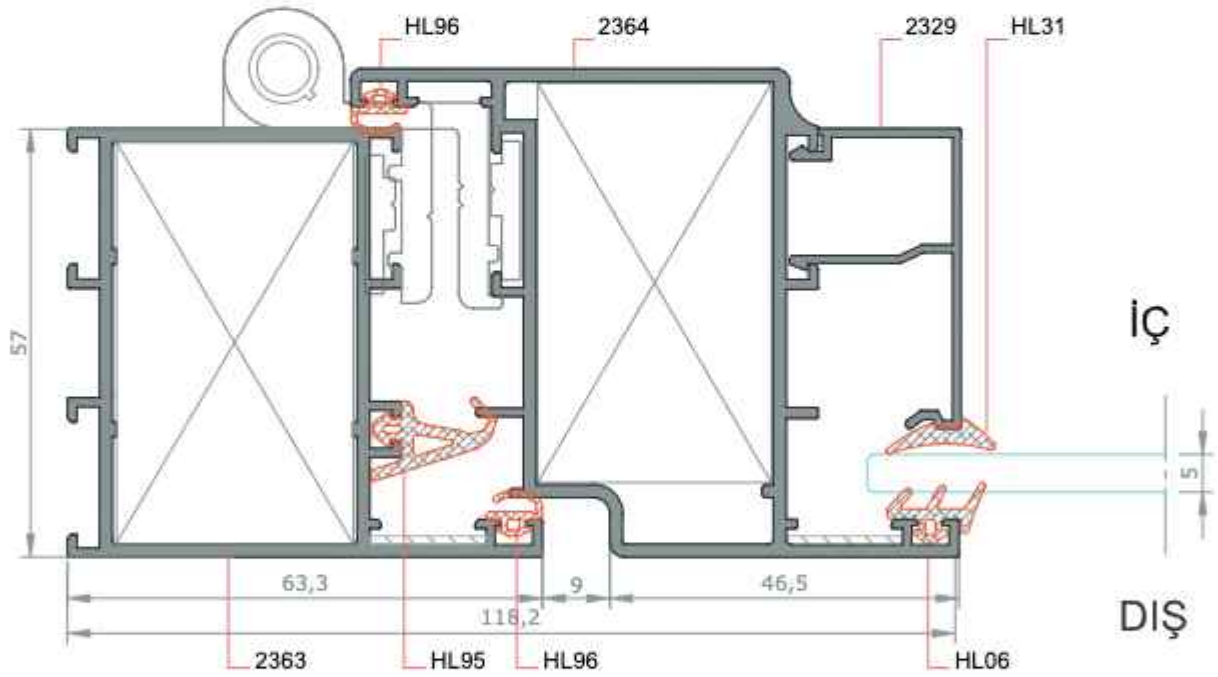

DETAY-2
ÖLÇEK:1/1

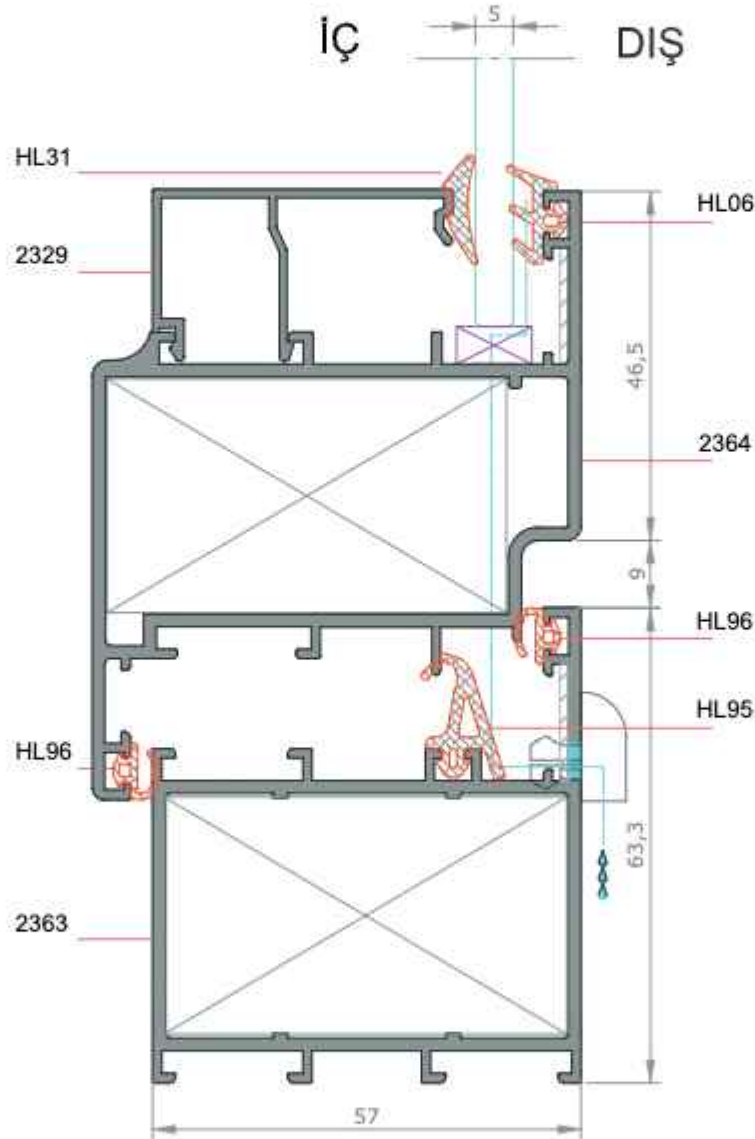
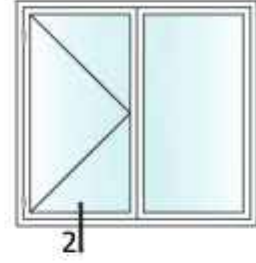

★ Yandaki profil birim ağırlıkları, bilgisayararda hesaplanmış teorik ağırlıklardır.

DETAY-3
ÖLÇEK:1/1

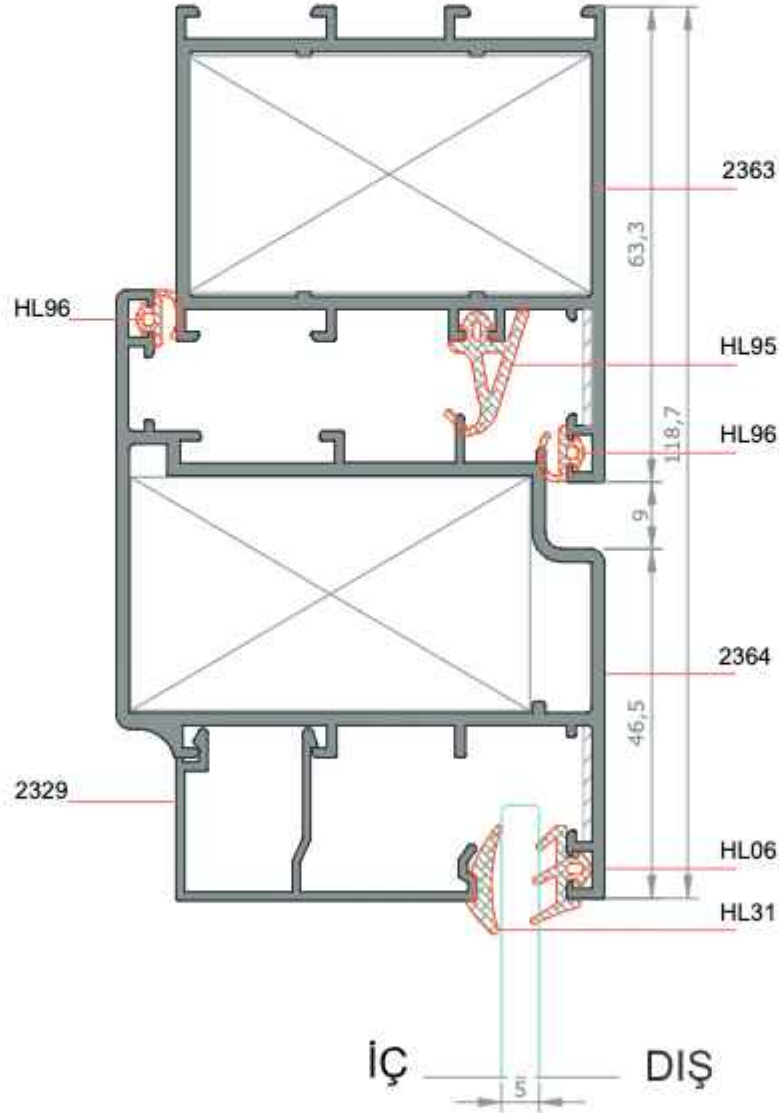
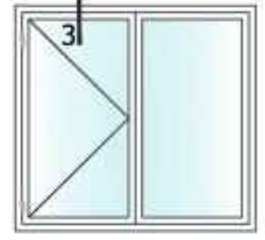

★ Yandaki profil birim ağırlıkları, bilgisayarda hesaplanmış teorik ağırlıklardır.

DETAY-4
ÖLÇEK:1/1

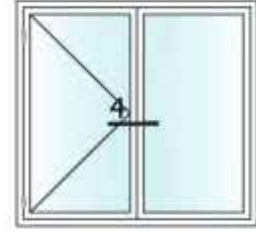

★ Yandaki profil birim ağırlıkları, bilgisayarda hesaplanmış teorik ağırlıklardır.

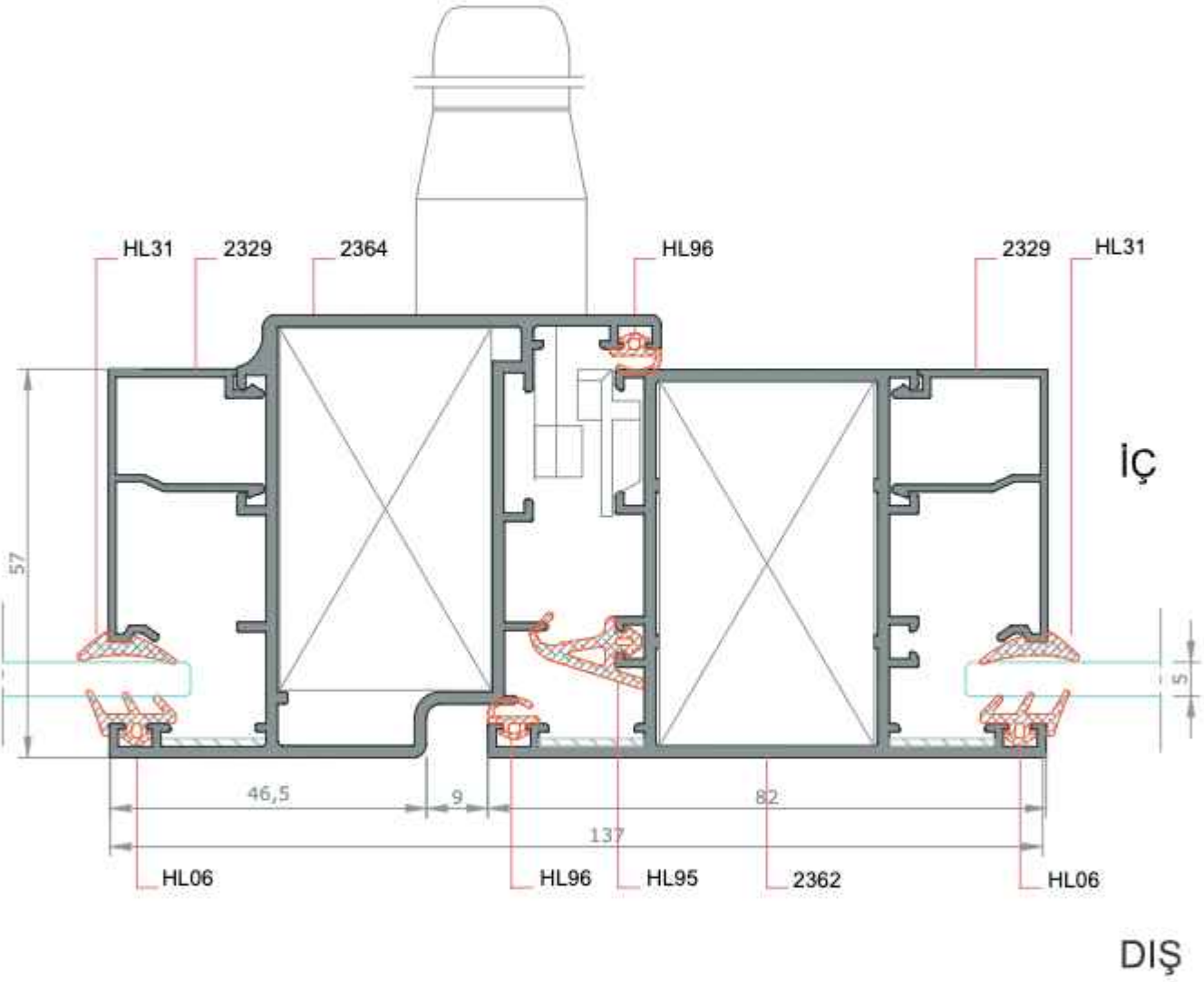

DETAY-5
ÖLÇEK:1/1

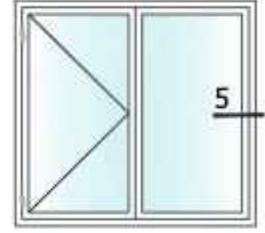

★ Yandaki profil birim ağırlıkları, bilgisayarla hesaplanmış teorik ağırlıklardır.

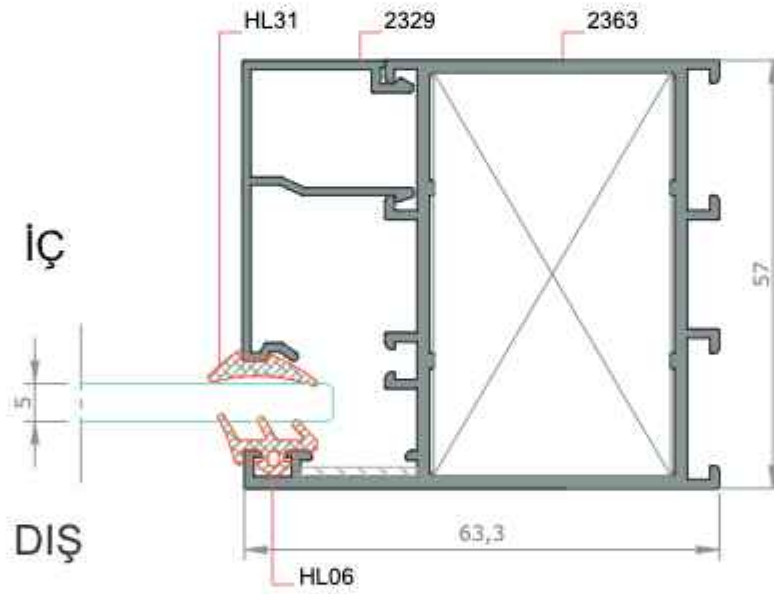

DETAY- 1a
ÖLÇEK:1/1

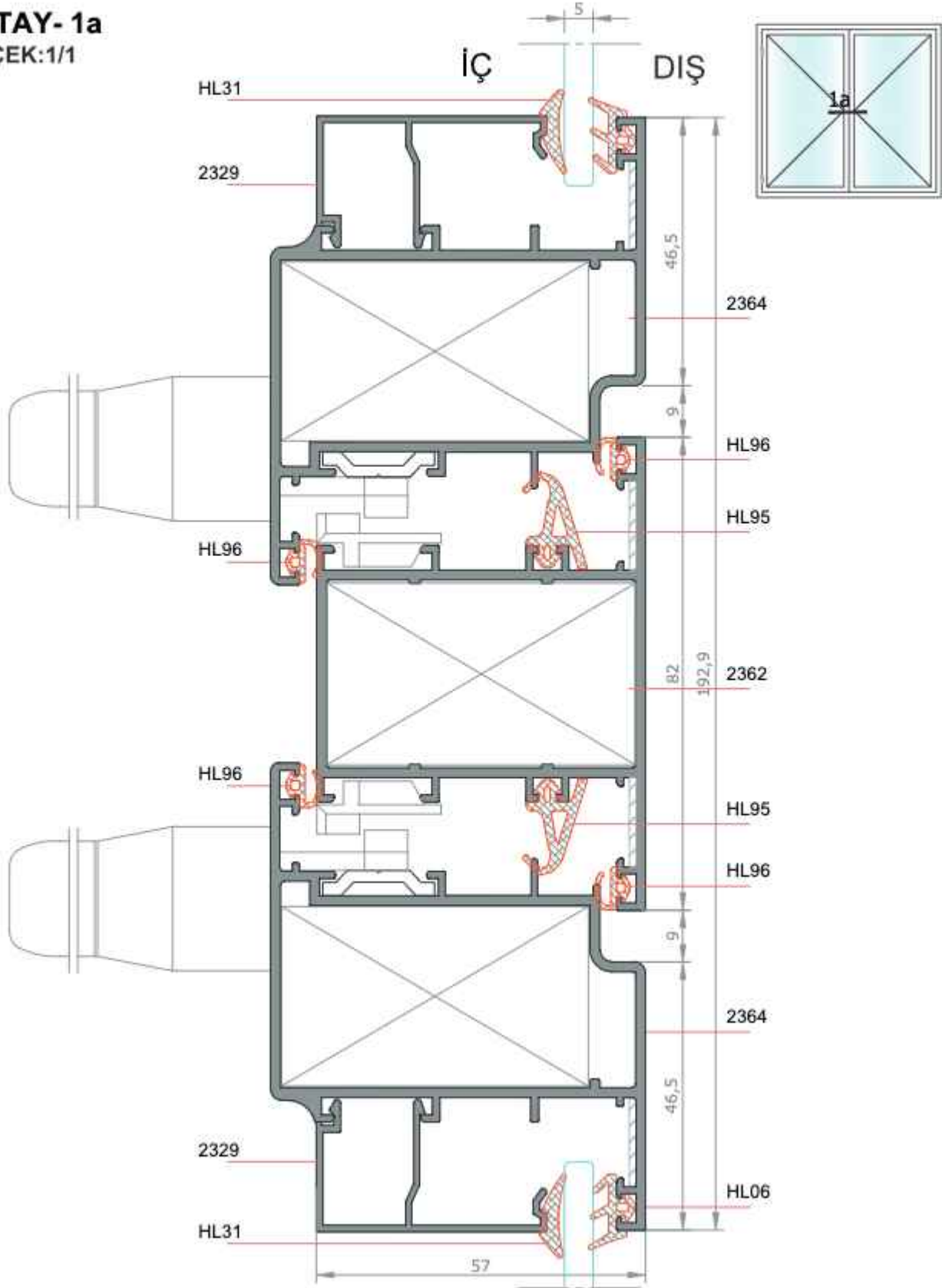

★ Yandaki profil birim ağırlıkları, bilgisayarda hesaplanmış teorik ağırlıklardır.

DETAY-1b
ÖLÇEK:1/1

★ Yandaki profil birim ağırlıkları, bilgisayarla hesaplanmış teorik ağırlıklardır.

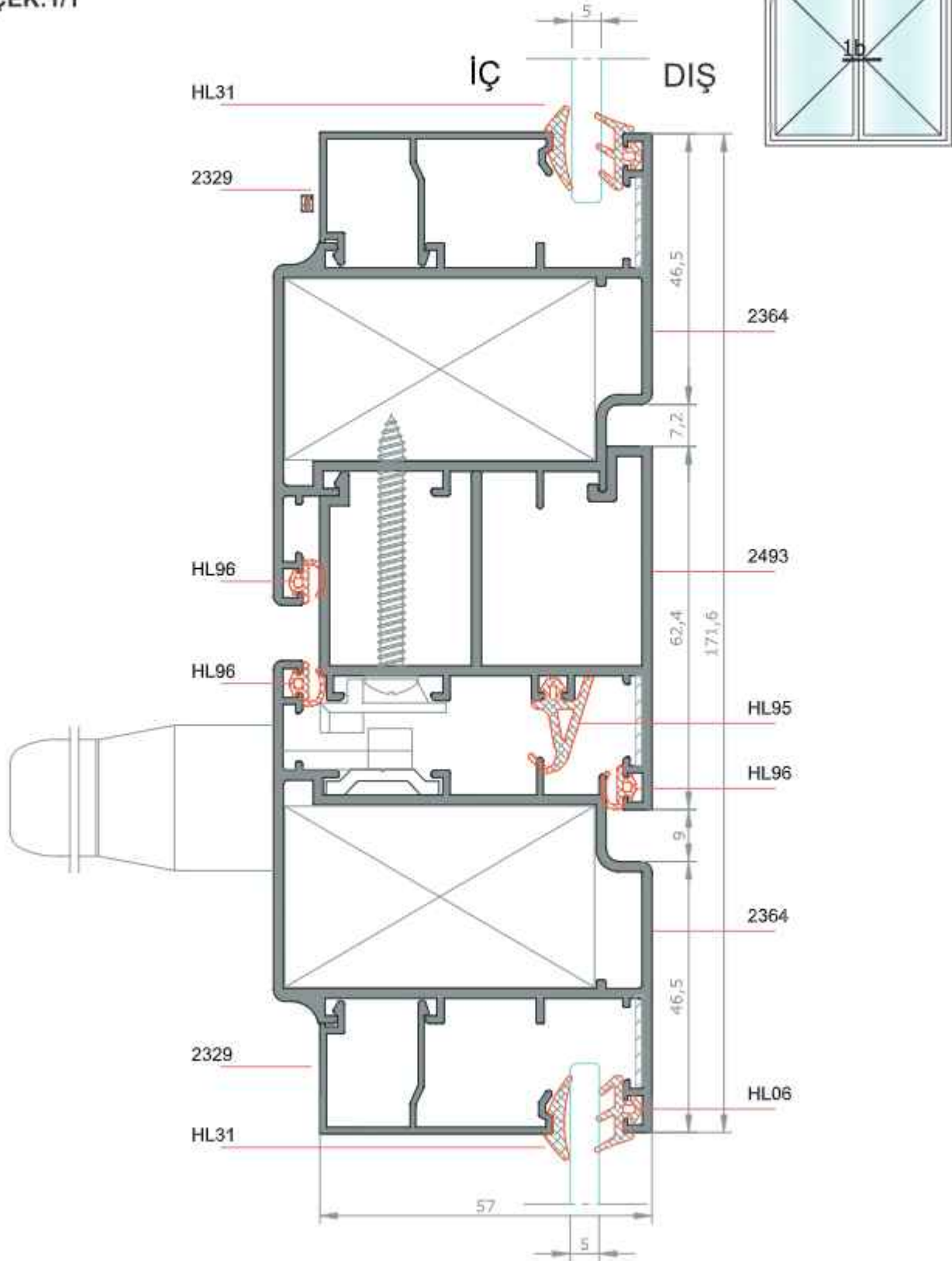

DETAY- 1
ÖLÇEK:1/1

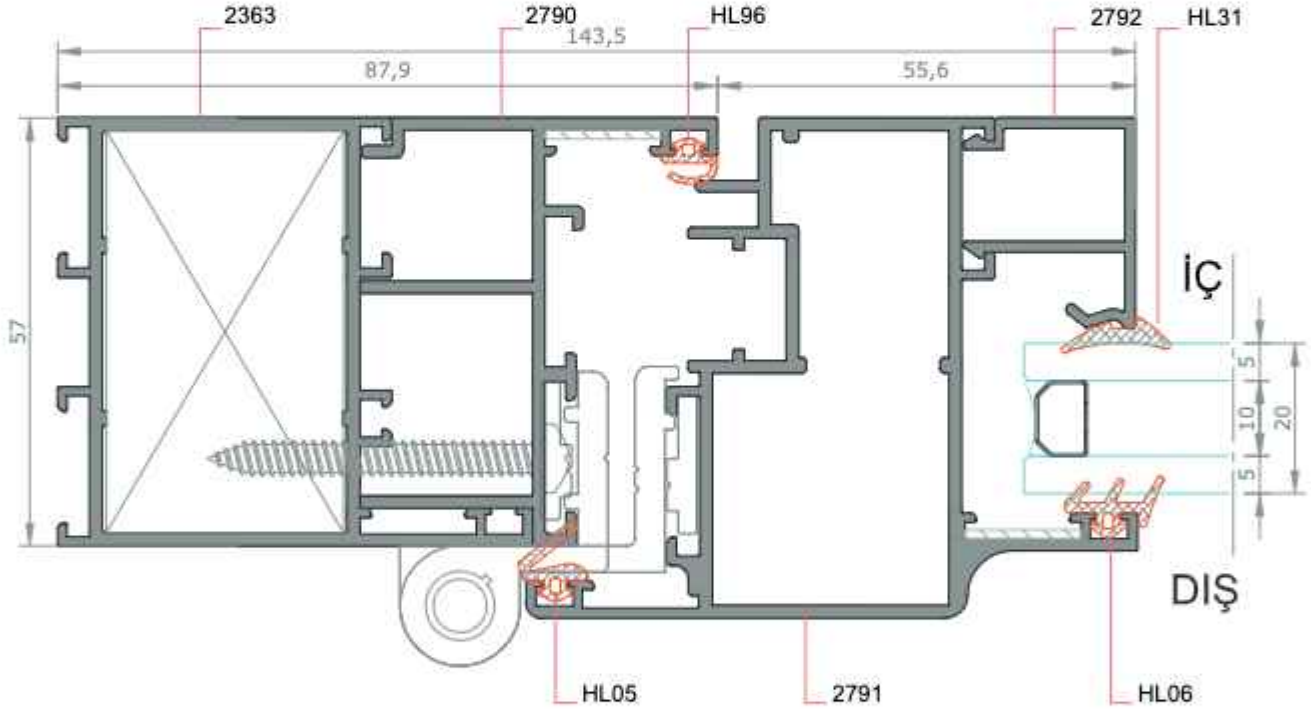
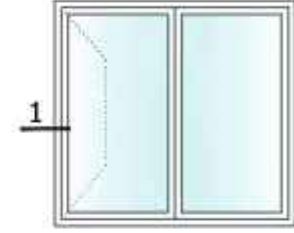

DETAY-2
ÖLÇEK:1/1

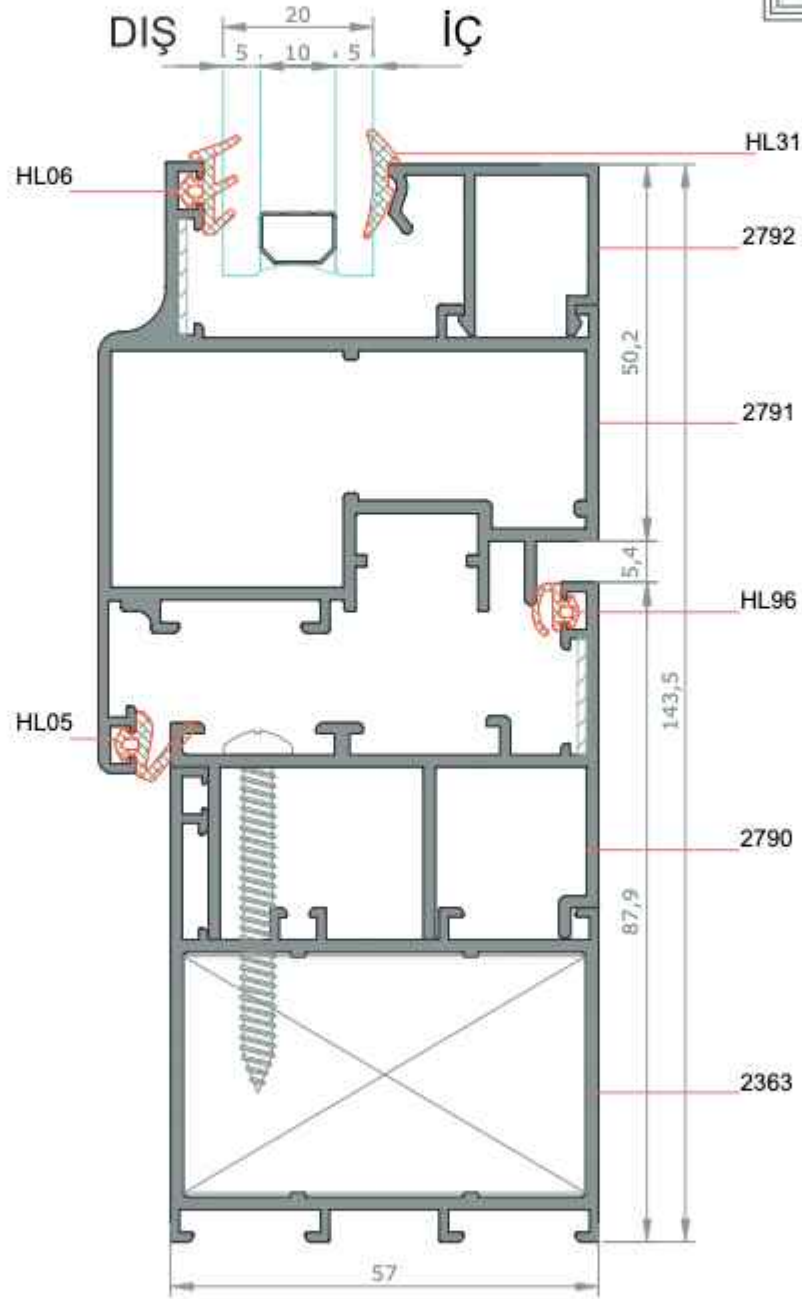
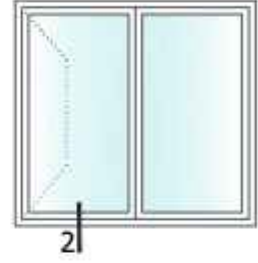

★ Yandaki profil birim ağırlıkları, bilgisayarla hesaplanmış teorik ağırlıklardır.

DETAY- 3
ÖLÇEK:1/1

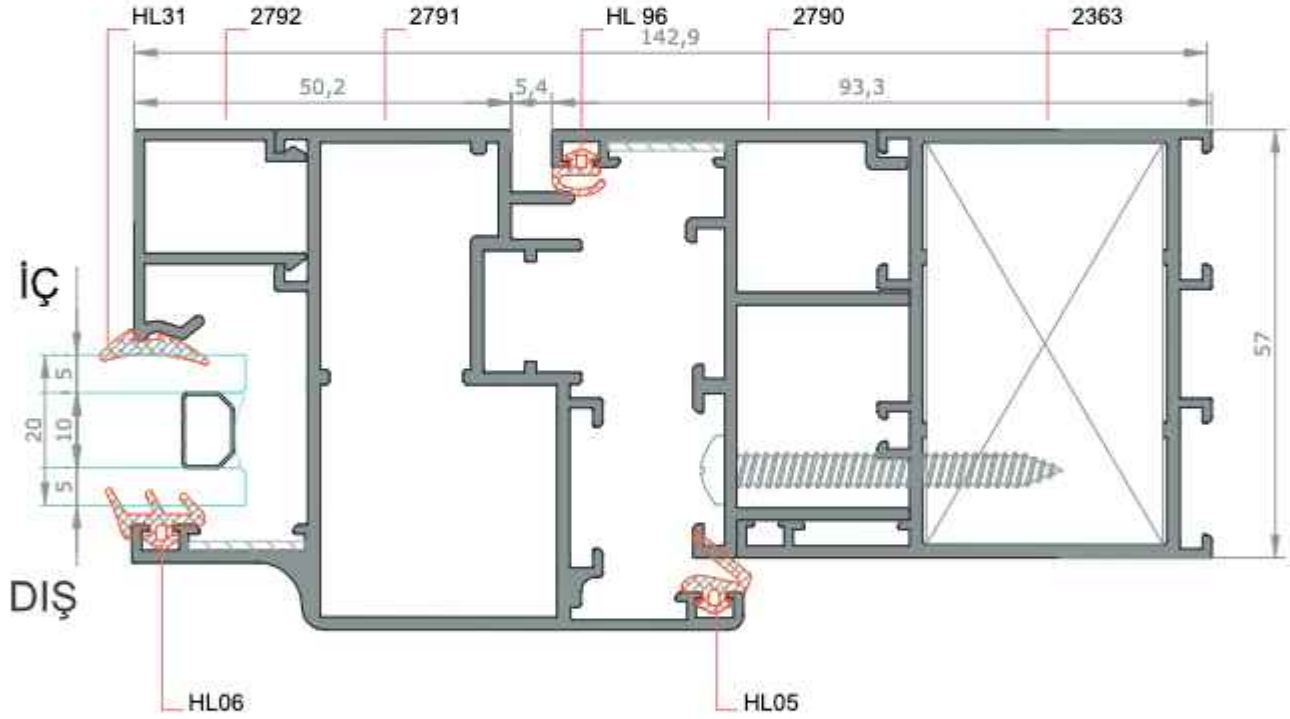
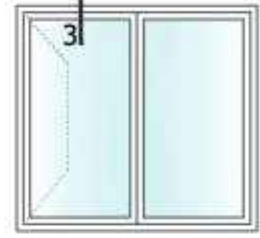

★ Yandaki profil birim ağırlıkları, bilgisayarda hesaplanmış teorik ağırlıklardır.

DETAY- 4
ÖLÇEK:1/1

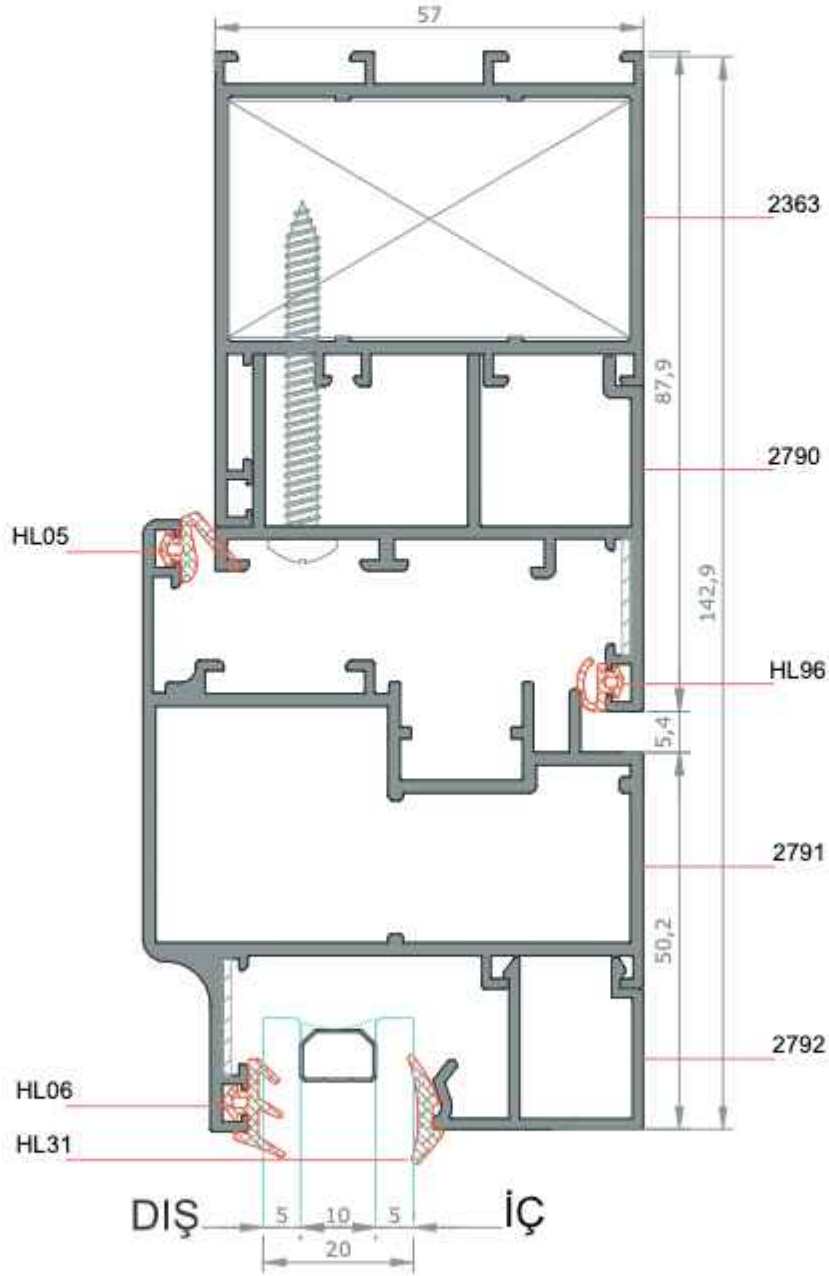
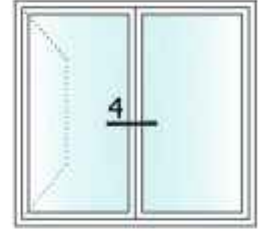

★ Yandaki profil birim ağırlıkları, bilgisayarla hesaplanmış teorik ağırlıklardır.

KAPI UYGULAMA TİPLERİ

★ Yandaki profil birim ağırlıkları, bilgisayarda hesaplanmış teorik ağırlıklardır.

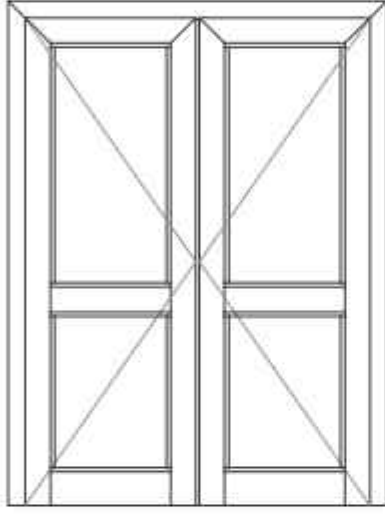

İçe Açılır Kapı

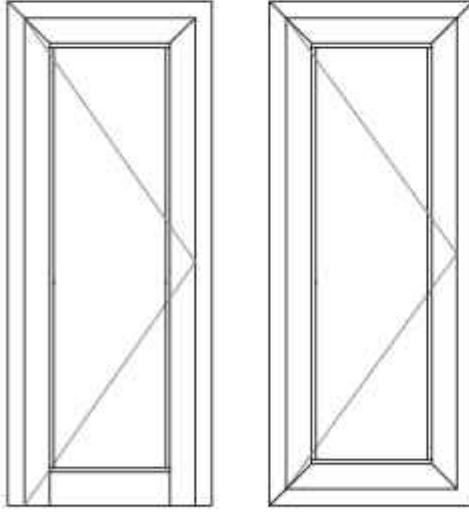

İçe Açılır Kapı

DETAY- 1
ÖLÇEK:1/1

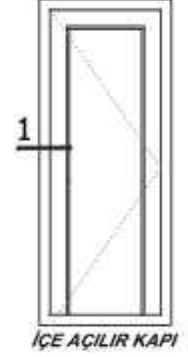

★ Yandaki profil birim ağırlıkları, bilgisayarla hesaplanmış teorik ağırlıklardır.

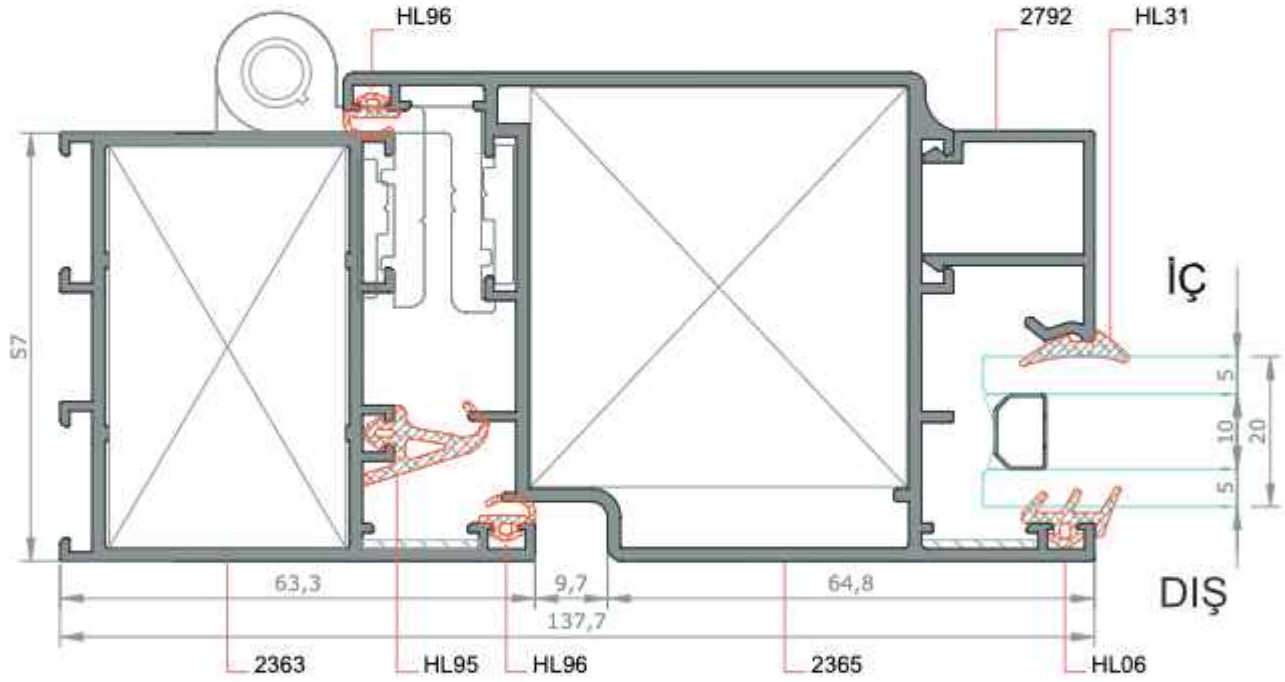

DETAY-2a
ÖLÇEK:1/1

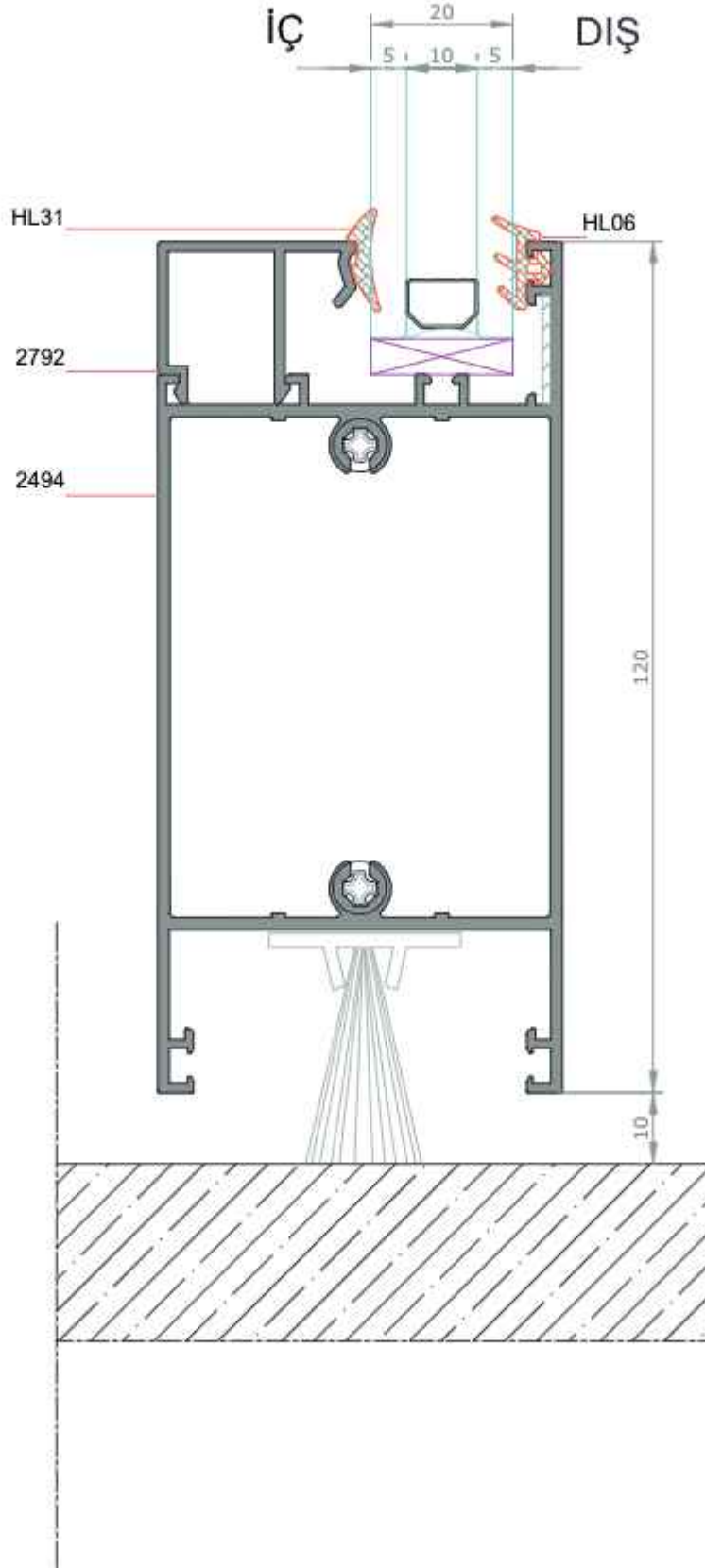

★ Yandaki profil birim ağırlıkları, bilgisayararda hesaplanmış teorik ağırlıklardır.

DETAY- 2b
ÖLÇEK:1/1

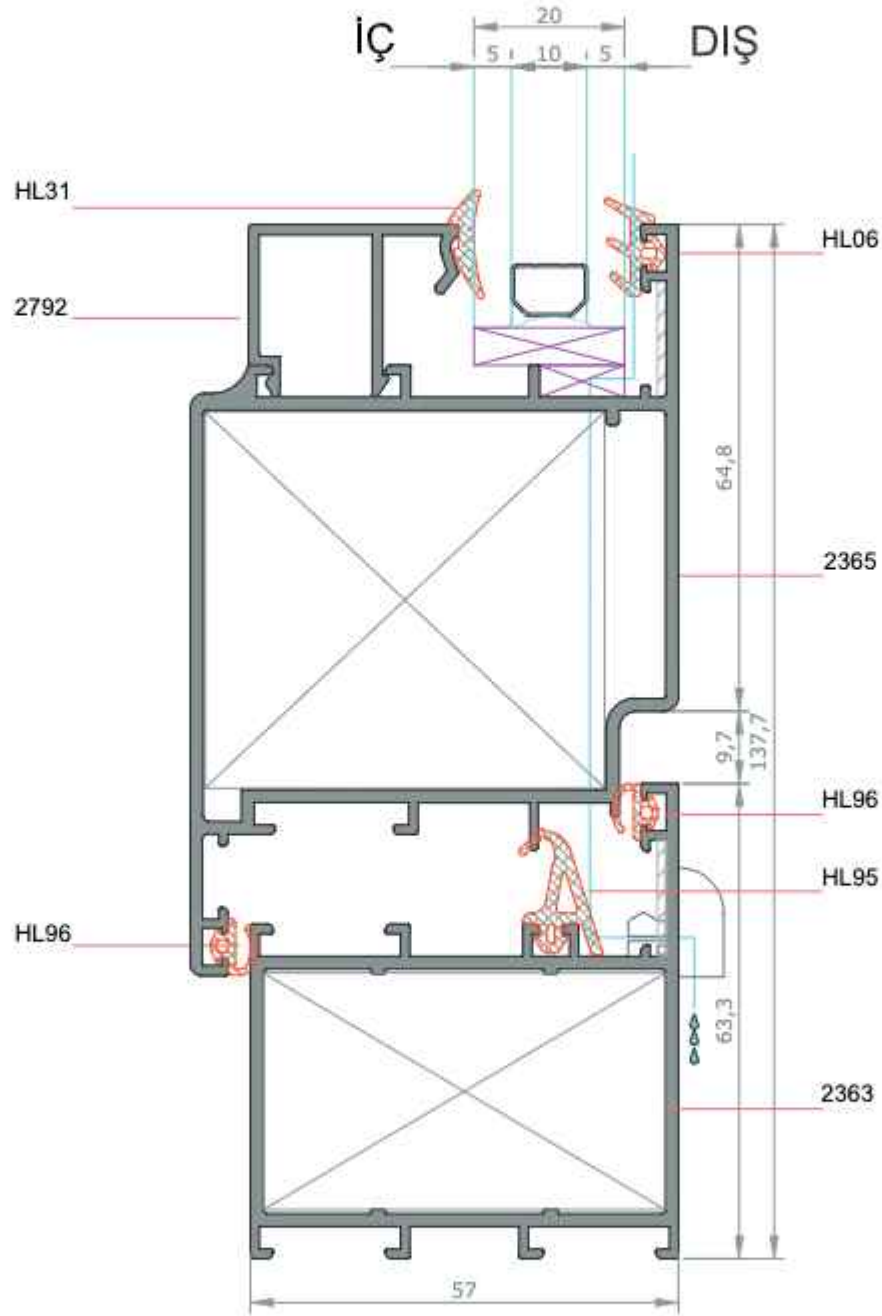

★ Yandaki profil birim ağırlıkları, bilgisayarla hesaplanmış teorik ağırlıklardır.

DETAY- 3
ÖLÇEK:1/1

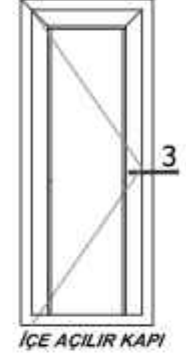

★ Yandaki profil birim ağırlıkları, bilgisayarda hesaplanmış teorik ağırlıklardır.

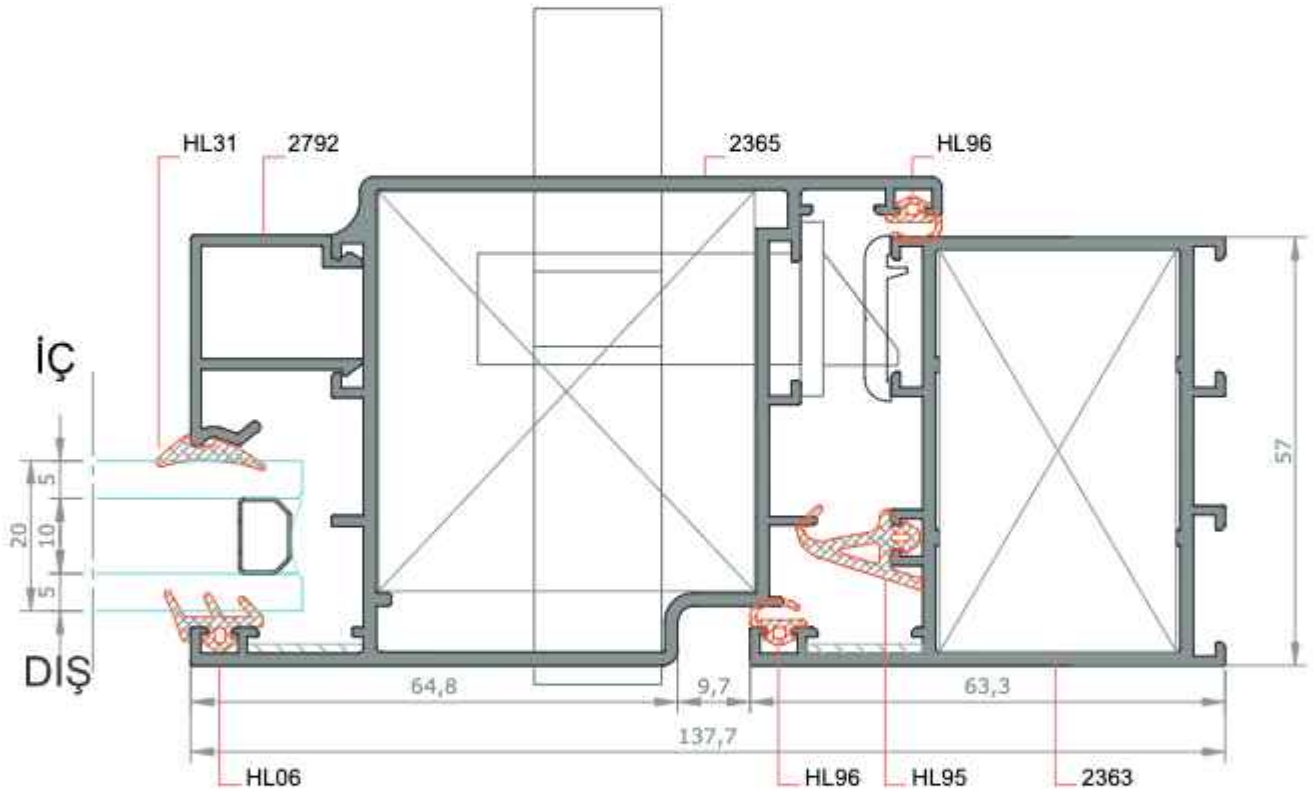

DETAY- 4
ÖLÇEK:1/1

★ Yandaki profil birim ağırlıkları, bilgisayarla hesaplanmış teorik ağırlıklardır.

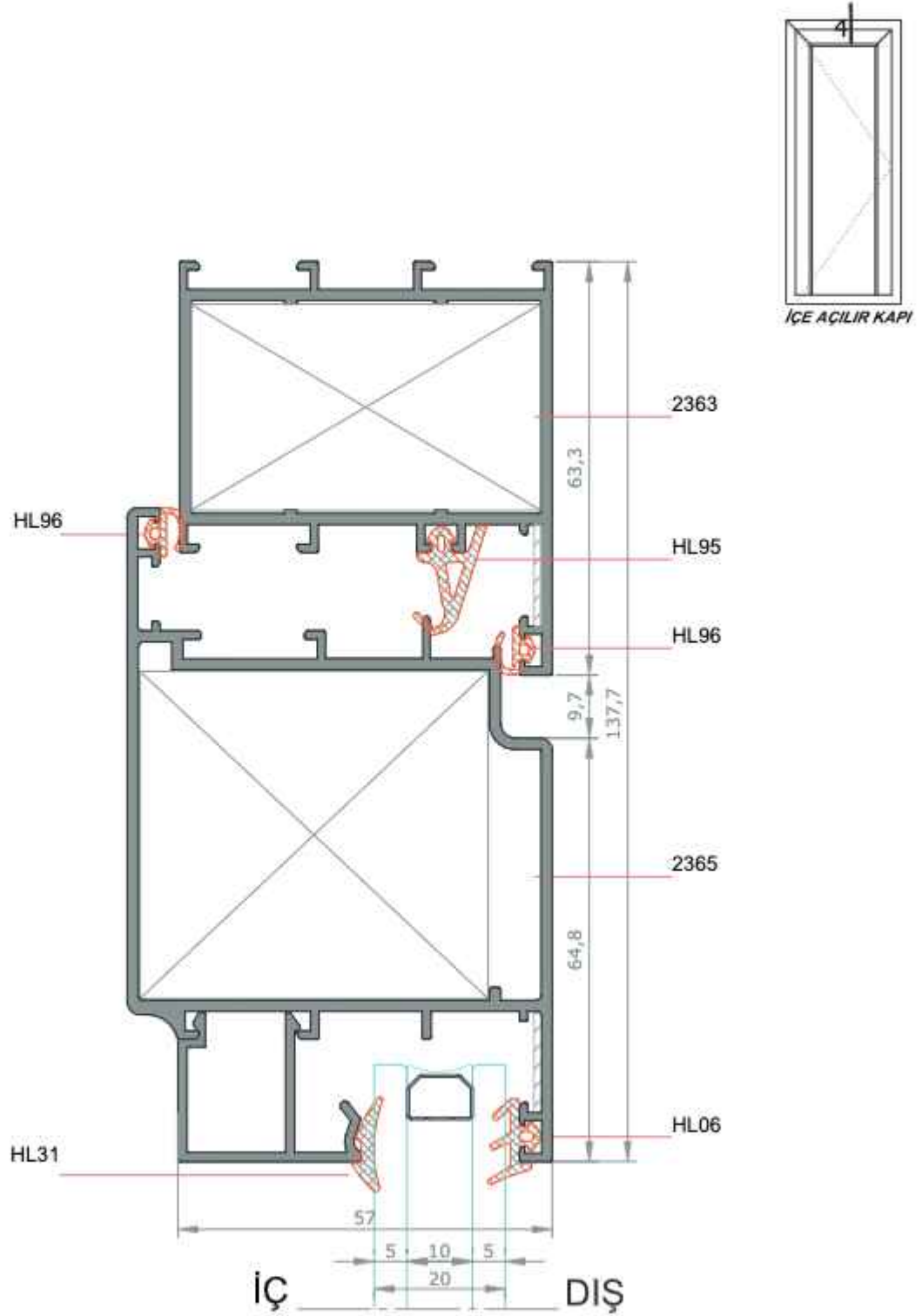

DETAY- 1
ÖLÇEK:1/1

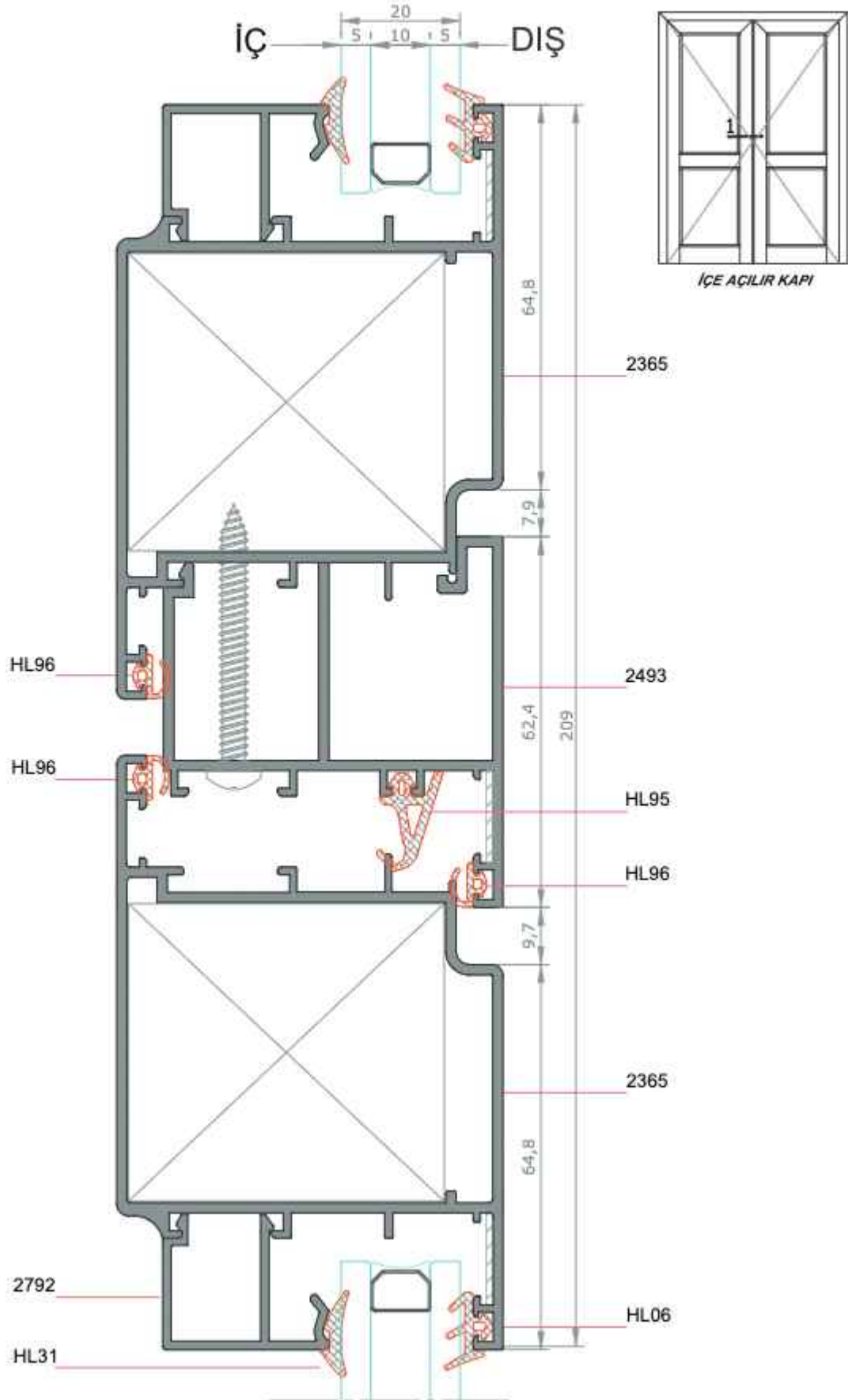

★ Yandaki profil birim ağırlıkları, bilgisayararda hesaplanmış teorik ağırlıklardır.

★ Yandaki profil birim ağırlıkları, bilgisayarla hesaplanmış teorik ağırlıklardır.

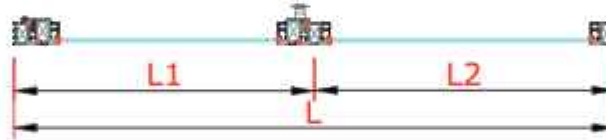
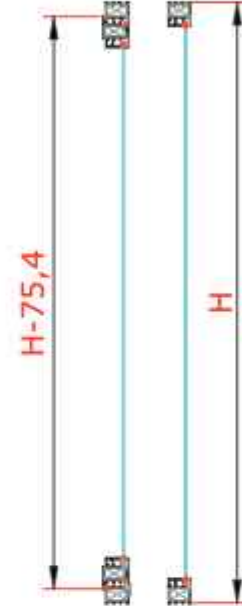
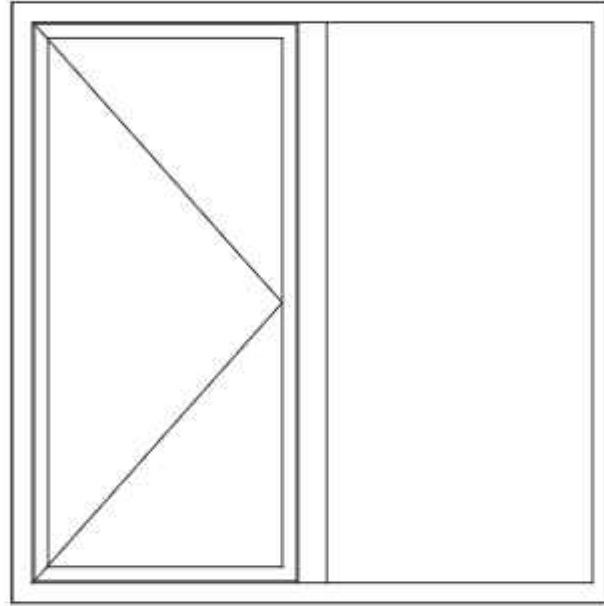

Profilin Adı	Profil Kesiti	Profil Kodu	Adet	Kesim Ölçüsü(mm)
Kasa Profili		2363	2	L
			2	H
Kanat Profili		2364	2	L1-53,15
			2	H-75,4
Orta Kayıt Profili		2362	1	H-80,5
Cam Çıtası Profili	Kanat	2329	2	
			2	
Cam Çıtası Profili	Kasa Orta Kayıt	2329	2	
			2	

Not: Üst Cam profiline 04 adet
profilye, alt cam profiline 04 adet
profilye takılmalıdır.

Not: Çerçeve profiline 04 adet
profilye, alt cam profiline 04 adet
profilye takılmalıdır.

Bağlantı Elemanları	Kod	Birim	Miktar
Köşe Takozu (Kasa)	K1538 531	Adet	4
Köşe Takozu (Kanat)	K1538 532	Adet	4
Köşe Gönye (Kasa)	MP56-04/3	Adet	4
Köşe Gönye (Kanat)	MP56-04/3	Adet	4
U Bağlantı(Orta Kayıt)	OK2343 535	Adet	2

Cam (Açılır)	Adet	Cam Detayı	Kesim Ölçüsü (mm)
Dış Cam	1		
İç Cam			

Cam (Sabit)	Adet	Cam Detayı	Kesim Ölçüsü (mm)
Dış Cam	1		
İç Cam			

★ Yandaki profil birim ağırlıkları, bilgisayararda hesaplanmış teorik ağırlıklardır.

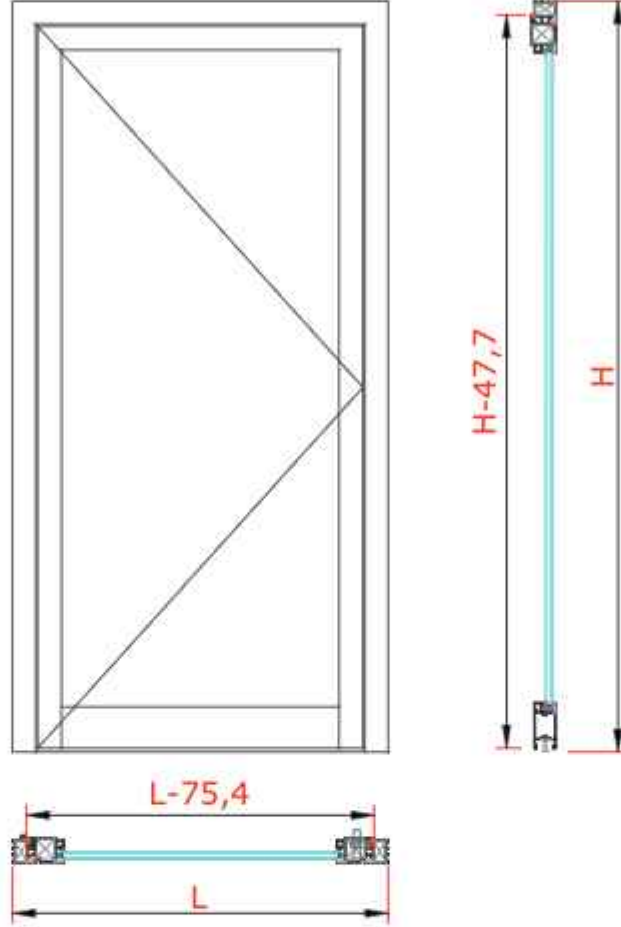

Profilin Adı	Profil Kesiti	Profil Kodu	Adet	Kesim Ölçüsü(mm)
Kasa Profili		2363	1	L
			2	H
Kanat Profili		2365	1	L-75.4
			2	H-47.7
Etek Profili		2494	1	L-229.4
Cam Çitası Profili	Kanat	2792	2	
			2	

Not: Cam L-47.7 mm profiline 10 mm kalınlığında cam veya keremden yapılabilir.

Bağlantı Elemanları	Kod	Birim	Miktar
Köşe Takozu (Kasa)	K1538 531	Adet	2
Köşe Takozu (Kanat)	K2342 532	Adet	2
Köşe Gönye (Kasa)	MP56-04/3	Adet	2
Köşe Gönye (Kanat)	MP56-04/3	Adet	2

CAM (Açılır)	Adet	Cam Deliyi	Kesim Ölçüsü (mm)
Dış Cam	1		
İç Cam			



PROFİL KATALOĐU















GXY HEKO DOĐRAMA SERİSİ



GXY HEKO DOOR & WINDOW SERIES

* Profil Ađırlıkları Teorik Olup Teslim Anındaki Ađırlık Geerlidir

* *Weight of profiles are theoretical, net weight will valid at the time of delivery.*

★ Yandaki profil birim ağırlıkları, bilgisayarda hesaplanmış teorik ağırlıklardır.

PROFİL KESİTİ	PROFİL KODU	PROFİL ADI	AĞIRLIK	ATALET MOMENTLERİ		SAYFA NO
				J_x (cm ⁴)	J_y (cm ⁴)	
	2829	Kasa Profili	0,949 kg/m	10,10	3,53	
	2831	Orta Kayıt Profili	1,058 kg/m	10,08	6,07	
	2830	Pencere Kanat Profili	1,129 kg/m	17,04	4,50	
	3373	Kapı Kanat Profili	1,445 kg/m	40,47	16,78	
	2838	Çift Kanat Adaptörü	1,199 kg/m	12,26	6,63	
	2839	Dışa Açılır Kanat Adaptörü	0,659 kg/m	5,66	2,50	
	2844	Etek Profili	2,378 kg/m	187,84	29,14	
	2843	Baza Orta Profili	2,163 kg/m	151,96	26,76	
	3575	Çift Cam Çıtası	0,301 kg/m	
	2842	Oval Çıta	0,316 kg/m	
	3374	Düz Çıta	0,327 kg/m	
	2835	Kanat Menteşesi	0,607kg/m	
	2836	Kanat Menteşesi	0,702 kg/m	
	2834	Orta Kayıt Bağlantı Profili	1,303 kg/m	

PROFİL KESİTİ	PROFİL KODU	PROFİL ADI	AĞIRLIK	ATALET MOMENTLERİ		SAYFA NO
				J_x (cm ⁴)	J_y (cm ⁴)	
	3041	Köşe Takozu	4,604 kg/m	
	2892	Köşe Takozu	2,810 kg/m	
	2957	Köşe Takozu	0,560 kg/m	

★ Yandaki profil birim ağırlıkları, bilgisayarda hesaplanmış teorik ağırlıklardır.

★ Yandaki profil birim ağırlıkları, bilgisayarda hesaplanmış teorik ağırlıklardır.

AKSESUAR KESİTİ	AKSESUAR KODU	AKSESUAR ADI	AĞIRLIK	PAKETLEME	SAYFA NO
	HL22	Tozluk Fiteli	90 gr/m	15kg/ 168m	
	HL23	Kanat Fiteli	38 gr/m	15kg/ 394m	
	HL32	Cam Fiteli	46 gr/m	15kg/326m	
	HL27(4mm)	Cam Fiteli	68 gr/m	15kg/ 220m	
	HL68(5mm)	Cam Fiteli	80 gr/m	15kg/ 187m	
	HL69(4mm)	Cam Fiteli	90 gr/m	15kg/166 m	
	HL04(3mm)	Kama Fiteli	60 gr/m	15kg/250 m	
	HL31(2mm)	Kama Fiteli	40 gr/m	15kg/375 m	
	HL24	Fırça Fiteli	92 gr/m	15kg/163 m	
	HE-7001	Pencere Kolu	...	50 Ad/ Paket	
	HA32-05/KIT	İspanyolet Kilit Takımı	...	250 Ad/ Paket	
	HE-7000	Dışa Açılır Mandallı Kol	...	100 Ad/ Paket	
	HE-9003	Double Metro-4218 2 pcs for each window	...	1 Ad/ Paket	
	HE-9400	Akses Kapı Kol	...	40 Ad/ Paket	

★ Yandaki profil birim ağırlıkları, bilgisayarda hesaplanmış teorik ağırlıklardır.

AKSESUAR KESİTİ	AKSESUAR KODU	AKSESUAR ADI	AĞIRLIK	PAKETLEME	SAYFA NO
	HE-8002	Bracket -1034 One for each top window	...	1 Ad/ Paket	
	HE-9404	Lock Reciver 06465.06 1 for each door	...	1 Ad/ Paket	
	HE-9402	Lock Cısa 44462 1 For Each Door	...	1 Ad/ Paket	
	HE-9701	Griyaj Tapası	...	1000 Ad/ Paket	
	HE-9700	Çıta Köşe Birleştirme Tapası	...	1000 Ad/ Paket	
	HE-9991	Pvc Tij	...	200 m/ Paket	
	MP-9998	Kesme ve Delme Makinası	...	1 Ad/ Paket	
	HE-9300	Menteşe	...	1 Ad/ Paket	
	HE-4601 (İthal)	Orta Çektirme 1445 T-Connector 1 Pc for every T connecting Parts	...	250 Ad/ Paket	
	HE-9403	Sylindir Cısa -08210-18-0 1 for each door	...	1 Ad/ Paket	
	HE-8001	5 Kademeli Makas	...	50 Ad/ Paket	

★ Yandaki profil birim ağırlıkları, bilgisayarda hesaplanmış teorik ağırlıklardır.

AKSESUAR KESİTİ	AKSESUAR KODU	AKSESUAR ADI	AĞIRLIK	PAKETLEME	SAYFA NO
	HE-8000	Ayarlı Makas	...	50 Ad/ Paket	
	HE-4600	Orta Bağlantı-485	...	100 Ad/ Paket	
	HE-9200	Çıt Çıt	...	50 Ad/ Paket	
	HE-9401	Kilit Karşılığı	...	100 Ad/ Paket	
	HE-9900	Giesse Pim Takımı	...	100 Ad/ Paket	
	HE-9800	Ayarlı Karşılık	...	100 Ad/ Paket	
	HE-9004	Cup For 1481-4077 1 pc for double leaf door 2 pcs for double leaf windows	...	1 Ad/ Paket	

★ Yandaki profil birim ağırlıkları, bilgisayarda hesaplanmış teorik ağırlıklardır.

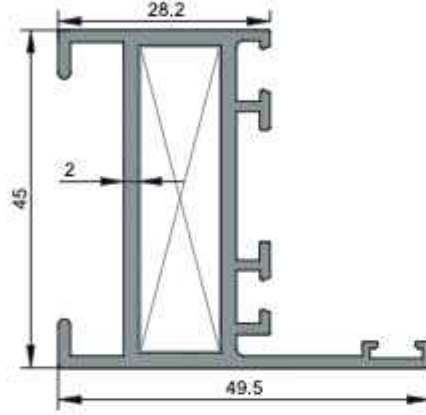

2829
Kasa Profili
0,949 kg/m
$J_x=10,10 \text{ cm}^4$ $J_y=3,53 \text{ cm}^4$

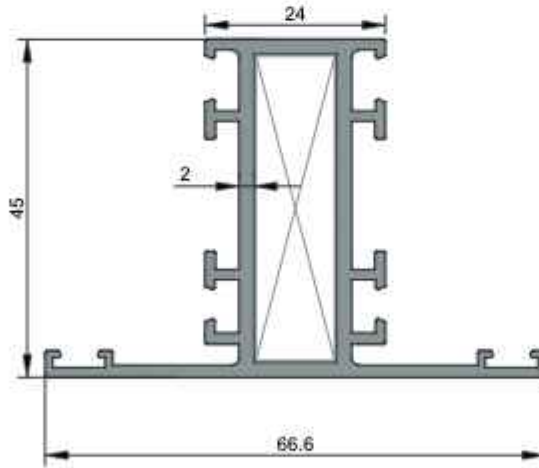

2831
Orta Kayıt Profili
1,058 kg/m
$J_x=10,08 \text{ cm}^4$ $J_y=6,07 \text{ cm}^4$

★ Yandaki profil birim ağırlıkları, bilgisayarda hesaplanmış teorik ağırlıklardır.

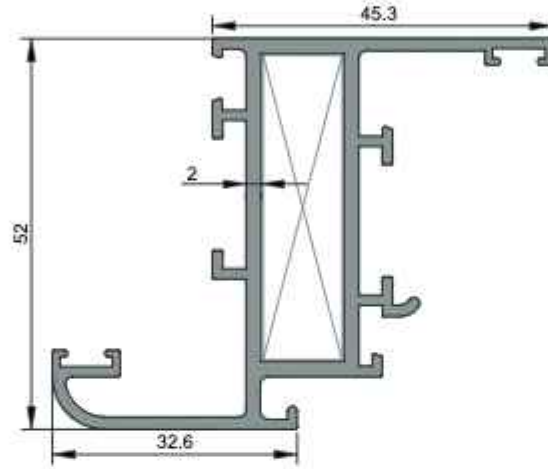

2830
Pencere Kanat Profili
1,129 kg/m
$J_x=17,04 \text{ cm}^4$ $J_y=4,50 \text{ cm}^4$

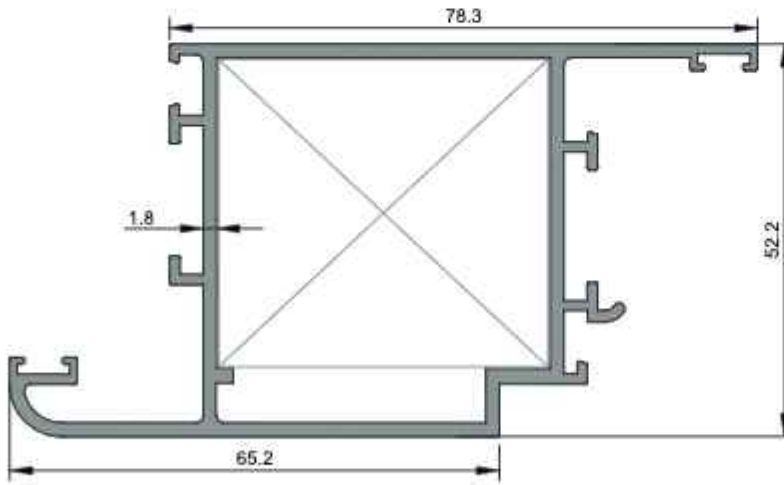

3373
Kapı Kanat Profili
1,445 kg/m
$J_x=40,47 \text{ cm}^4$ $J_y=16,78 \text{ cm}^4$

★ Yandaki profil birim ağırlıkları, bilgisayararda hesaplanmış teorik ağırlıklardır.

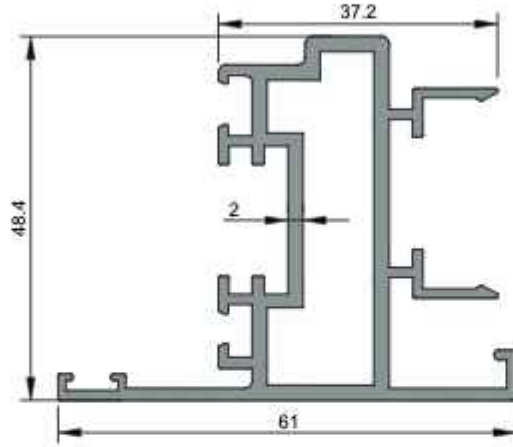

2838
Çift Kanat Adaptörü
1,199 kg/m
$J_x=12,26 \text{ cm}^4$ · $J_y=6,63 \text{ cm}^4$

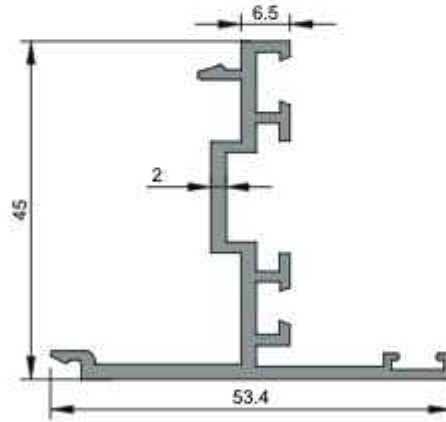

2839
Dışa Açılır Kanat Adaptörü
0,659 kg/m
$J_x=5,66 \text{ cm}^4$ · $J_y=2,50 \text{ cm}^4$

★ Yandaki profil birim ağırlıkları, bilgisayarla hesaplanmış teorik ağırlıklardır.

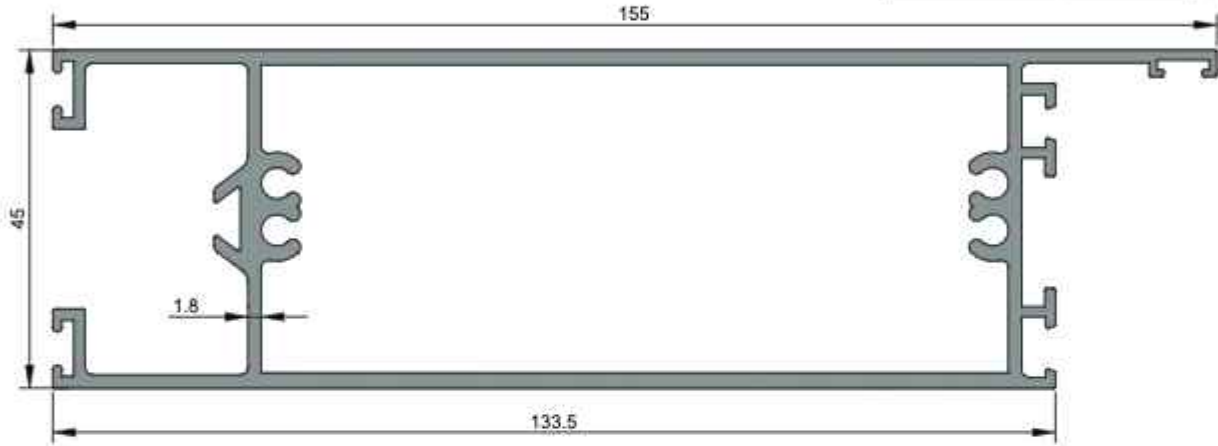

★ Yandaki profil birim ağırlıkları, bilgisayarda hesaplanmış teorik ağırlıklardır.

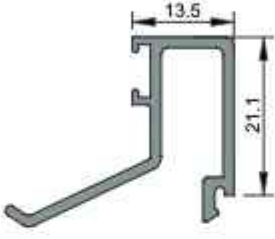

3575
Cam Çıtası
0,301 kg/m

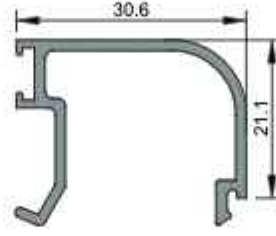

2842
Cam Çıtası
0,316 kg/m

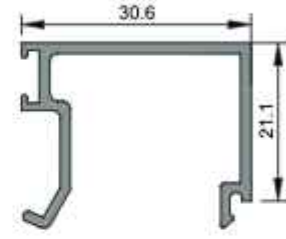

3374
Cam Çıtası
0,327 kg/m

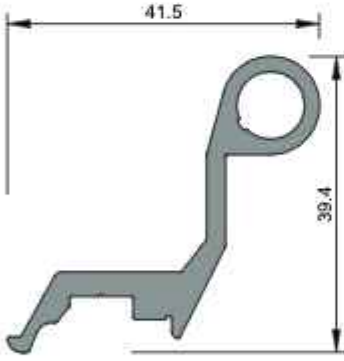

2835
Kanat Menteşesi
0,670 kg/m

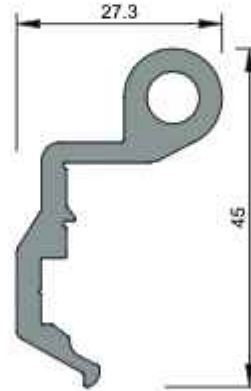

2836
Kasa Menteşesi
0,702 kg/m

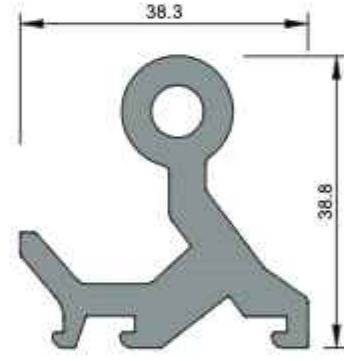

2834
Orta Kayıt Bağlantısı
1,303 kg/m

★ Yandaki profil birim ağırlıkları, bilgisayarda hesaplanmış teorik ağırlıklardır.

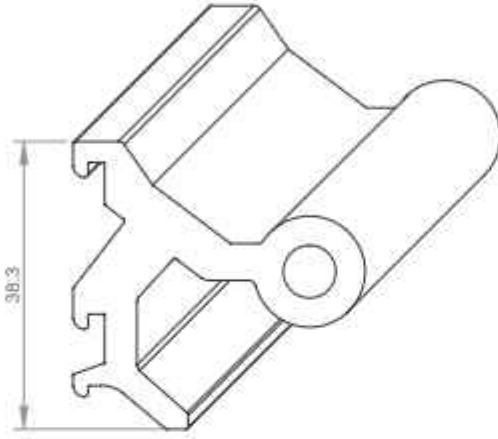

2834
Orta Kayıt Bağlantısı
1,303 kg/m

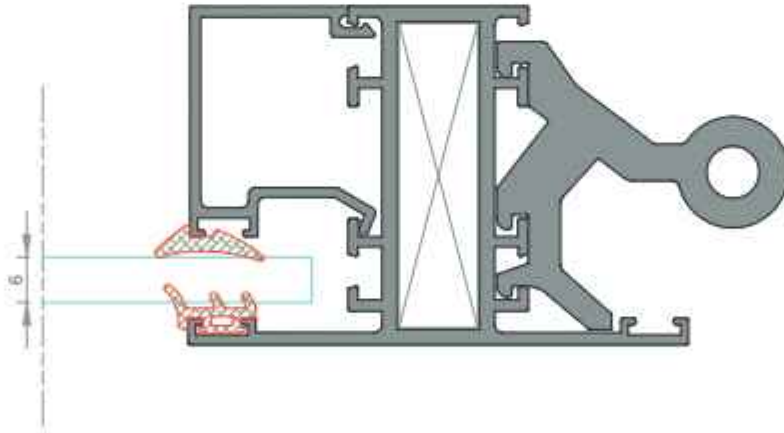

KÖŞE TAKOZU KESİM ÖLÇÜLERİ

★ Yandaki profil birim ağırlıkları, bilgisayararda hesaplanmış teorik ağırlıklardır.

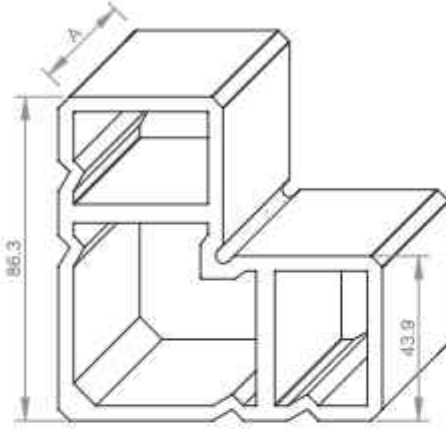

3041
Köşe Takozu
4,604 kg/m

Aksesuar Kodu	Profil Kodu	Kesim Ölçüsü A(mm)
K3041 409	3373	40.9

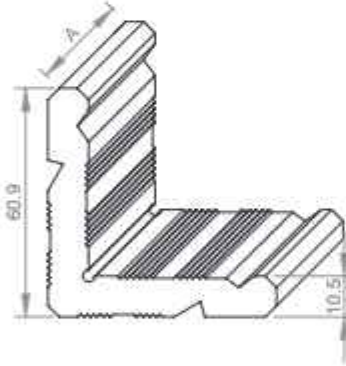

2892
Köşe Takozu
2,925 kg/m

Aksesuar Kodu	Profil Kodu	Kesim Ölçüsü A(mm)
K2892 405	2829	40.5
K2892 405	2831	40.5
K2892 405	2830	40.5

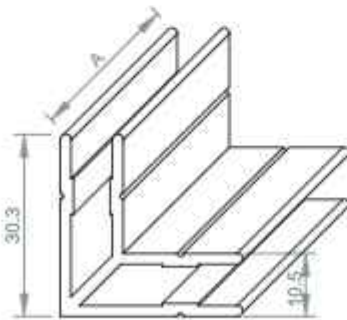

2957
Köşe Takozu
2,925 kg/m

Aksesuar Kodu	Profil Kodu	Kesim Ölçüsü A(mm)
K2957 405	2829	40.5
K2957 405	2831	40.5
K2957 405	2830	40.5

ÖLÇEK:1/1

CAMLAMA SEÇENEK TABLOSU

★ Yandaki profil birim ağırlıkları, bilgisayarla hesaplanmış teorik ağırlıklardır.

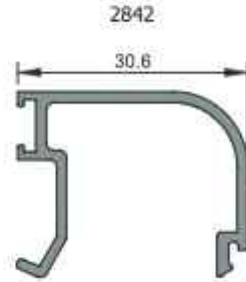
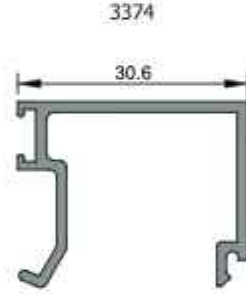
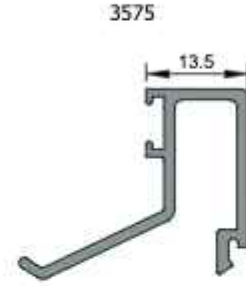
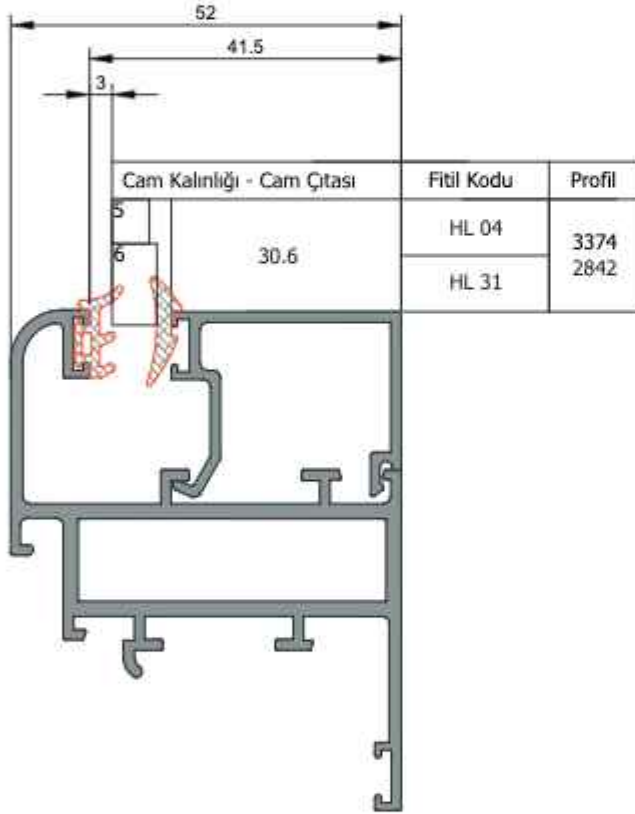

PENCERE UYGULAMA TİPLERİ

★ Yandaki profil birim ağırlıkları, bilgisayarda hesaplanmış teorik ağırlıklardır.

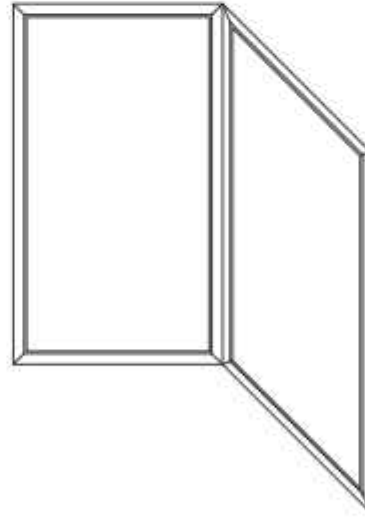
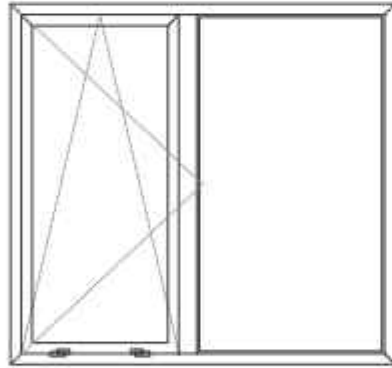
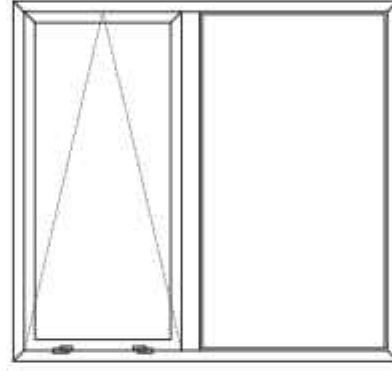
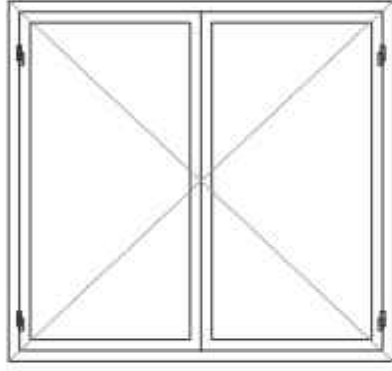

DETAY- 1
ÖLÇEK:1/1

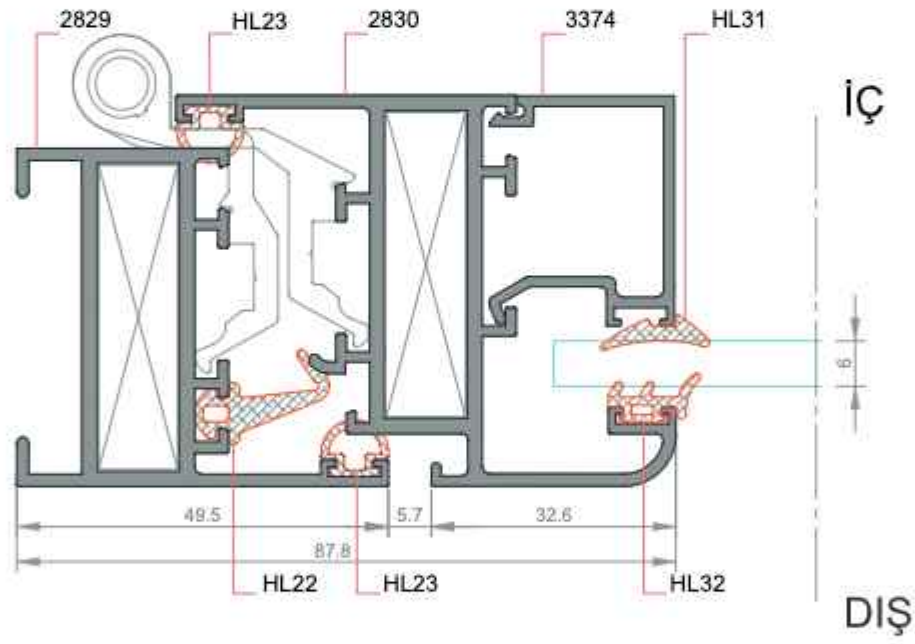
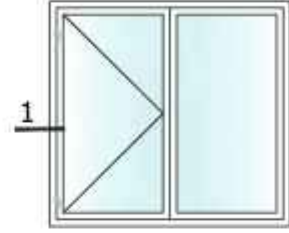

★ Yandaki profil birim ağırlıkları, bilgisayarla hesaplanmış teorik ağırlıklardır.

DETAY- 2
ÖLÇEK:1/1

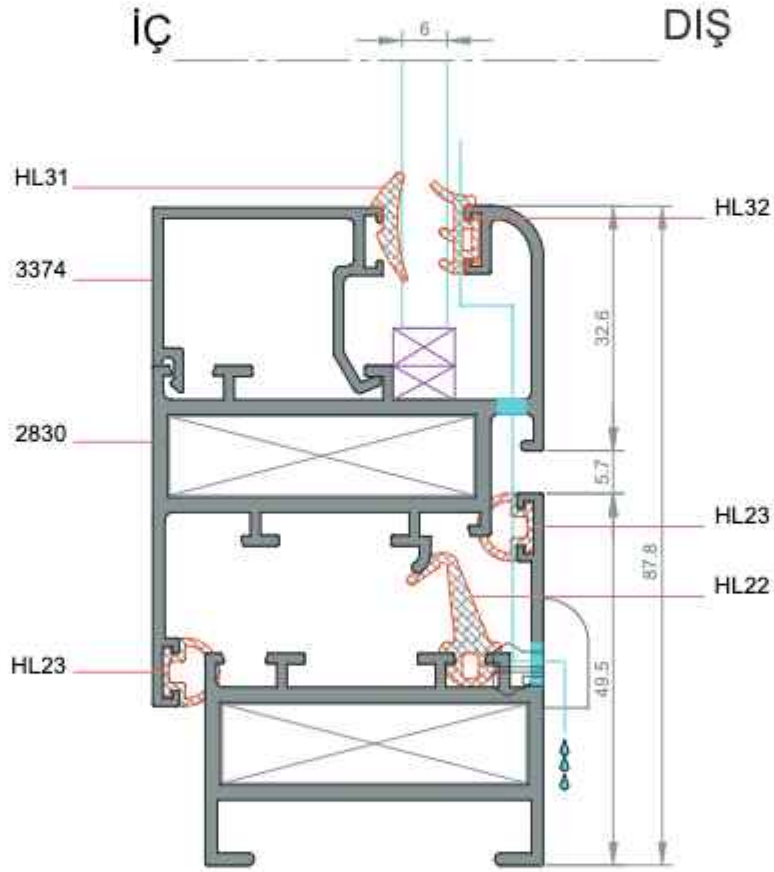
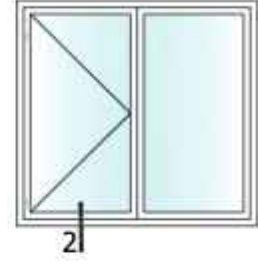

★ Yandaki profil birim ağırlıkları, bilgisayarda hesaplanmış teorik ağırlıklardır.

DETAY- 3
ÖLÇEK:1/1

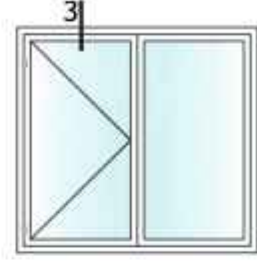

★ Yandaki profil birim ağırlıkları, bilgisayarda hesaplanmış teorik ağırlıklardır.

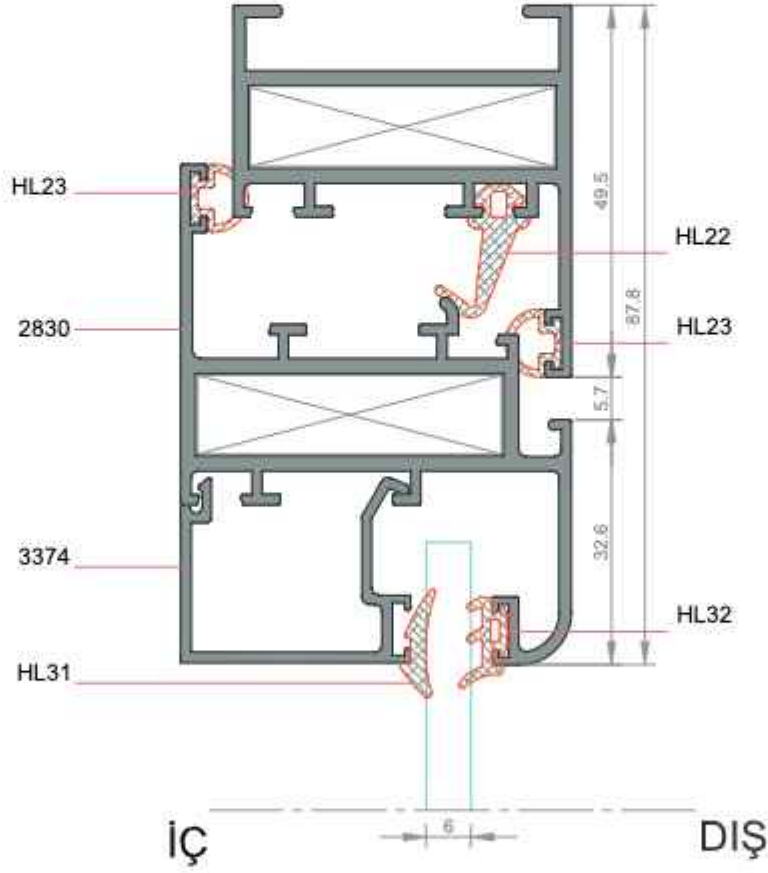

DETAY- 4
ÖLÇEK:1/1

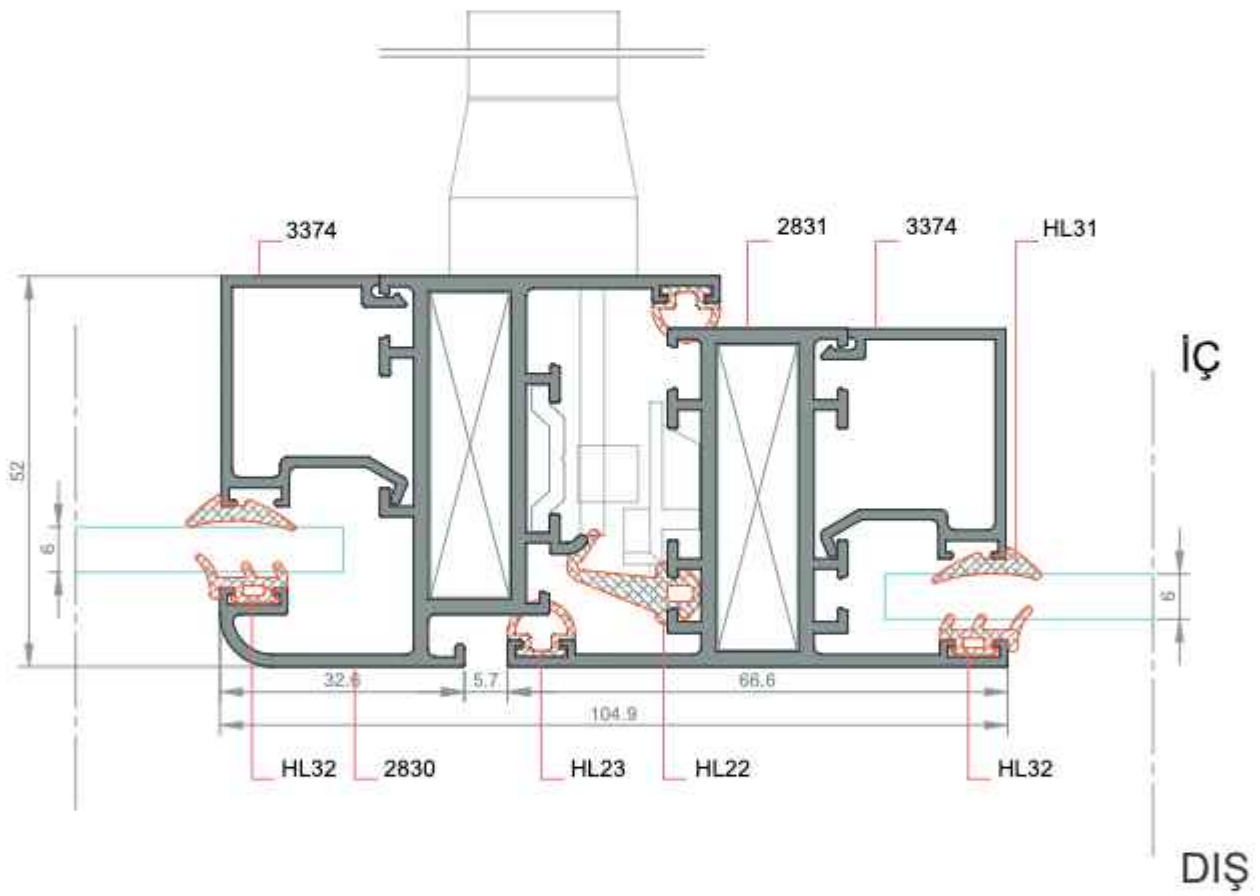
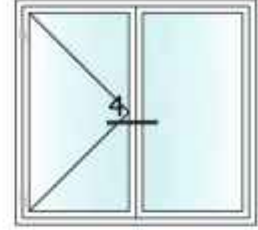

DETAY- 5
ÖLÇEK:1/1

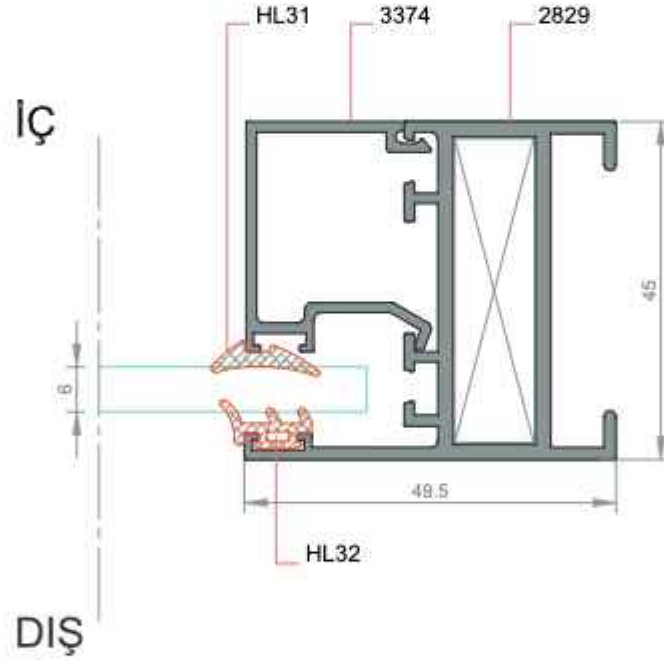
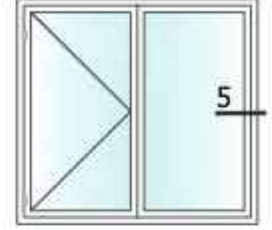

★ Yandaki profil birim ağırlıkları, bilgisayararda hesaplanmış teorik ağırlıklardır.

DETAY- 1a
ÖLÇEK:1/1

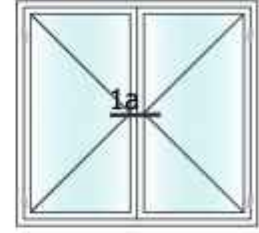

★ Yandaki profil birim ağırlıkları, bilgisayarda hesaplanmış teorik ağırlıklardır.

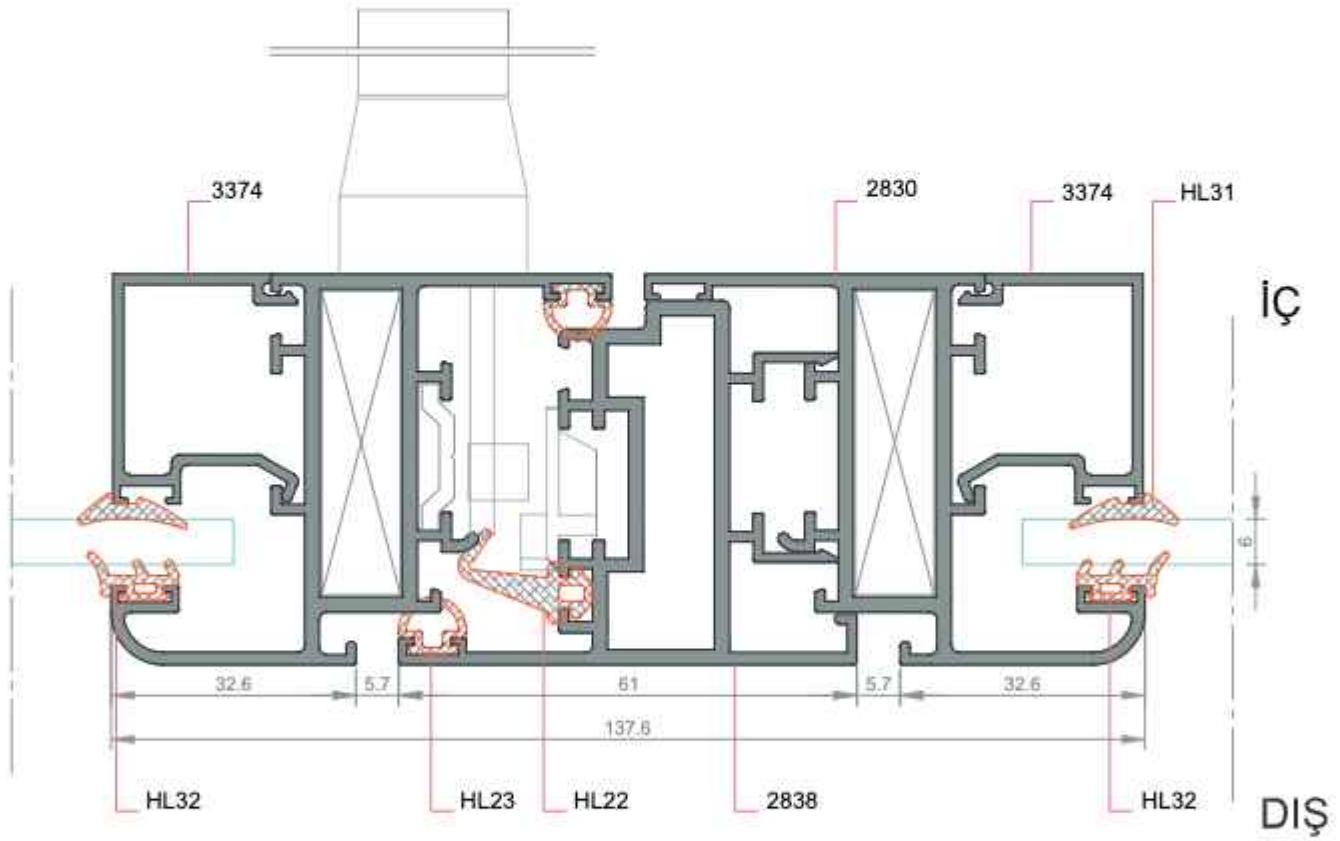

DETAY- 1b

ÖLÇEK:1/1

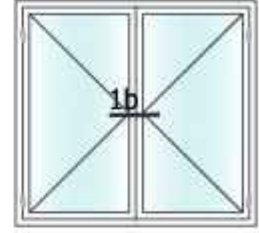

★ Yandaki profil birim ağırlıkları, bilgisayarla hesaplanmış teorik ağırlıklardır.

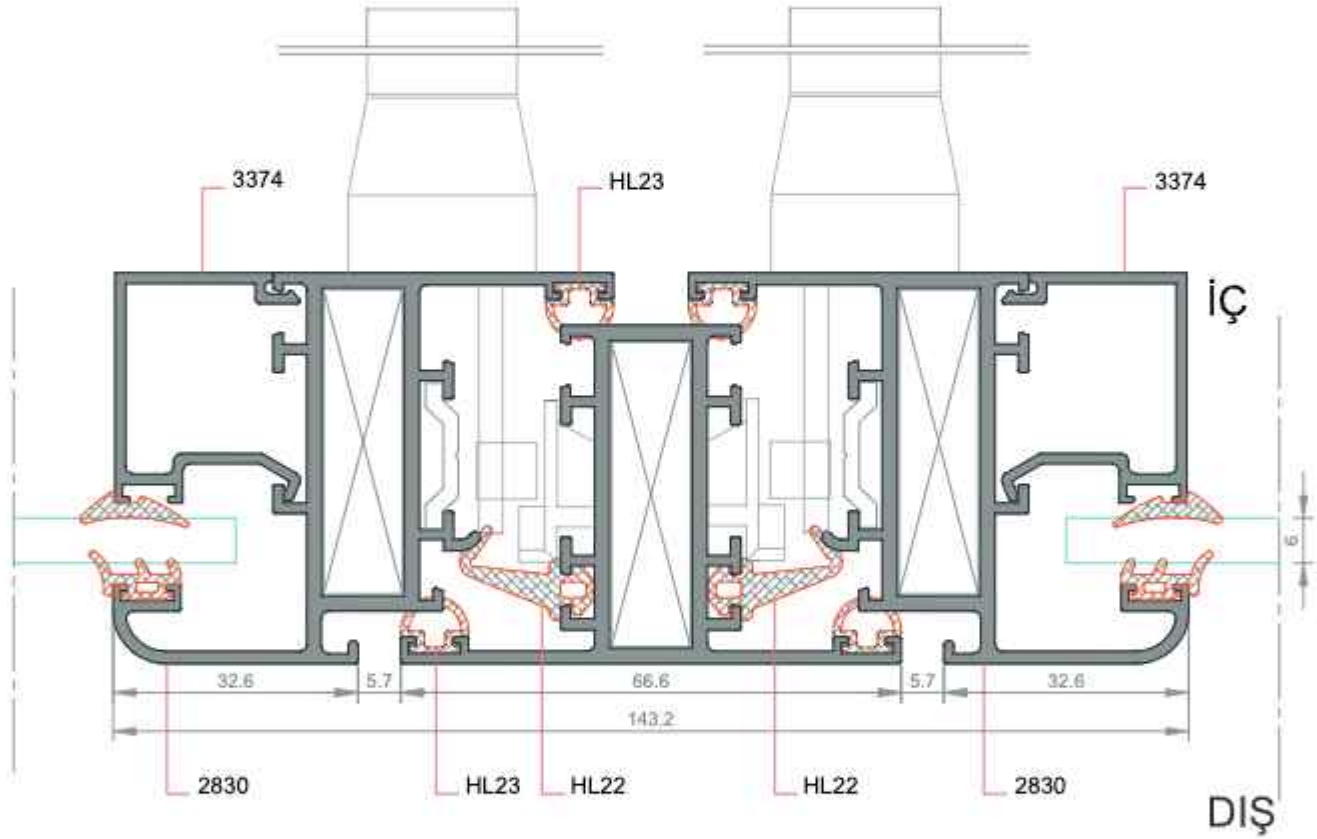

DETAY- 1
ÖLÇEK:1/1

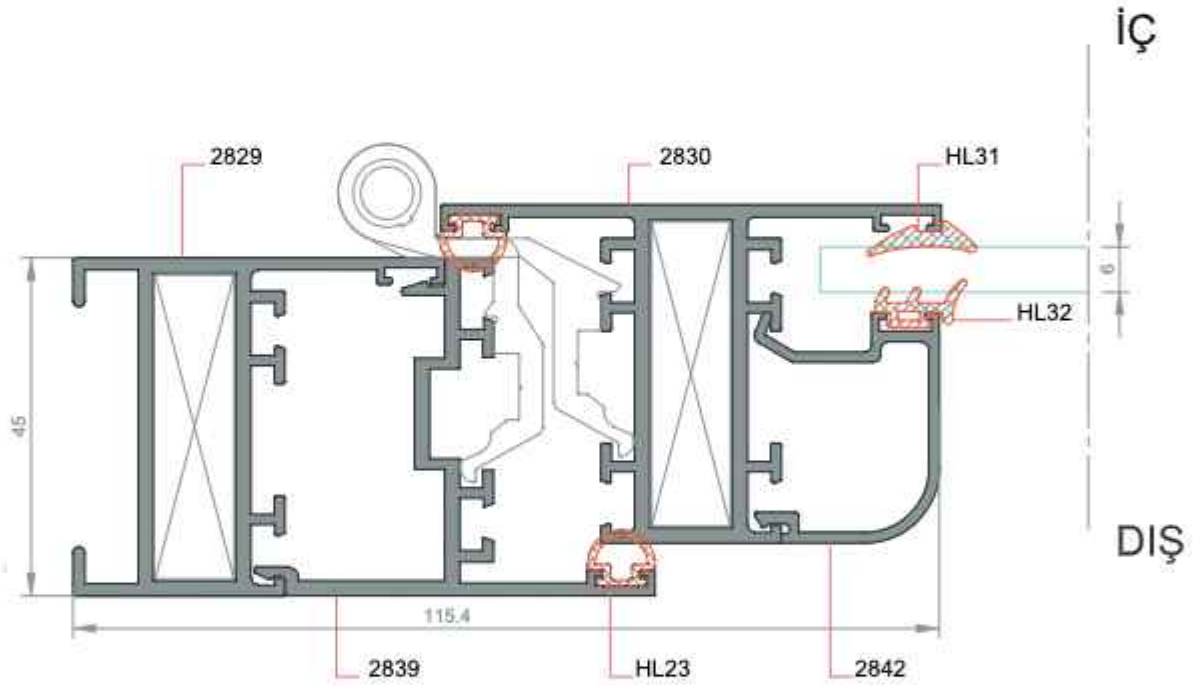
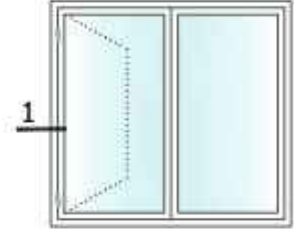

★ Yandaki profil birim ağırlıkları, bilgisayarda hesaplanmış teorik ağırlıklardır.

DETAY- 2
ÖLÇEK:1/1

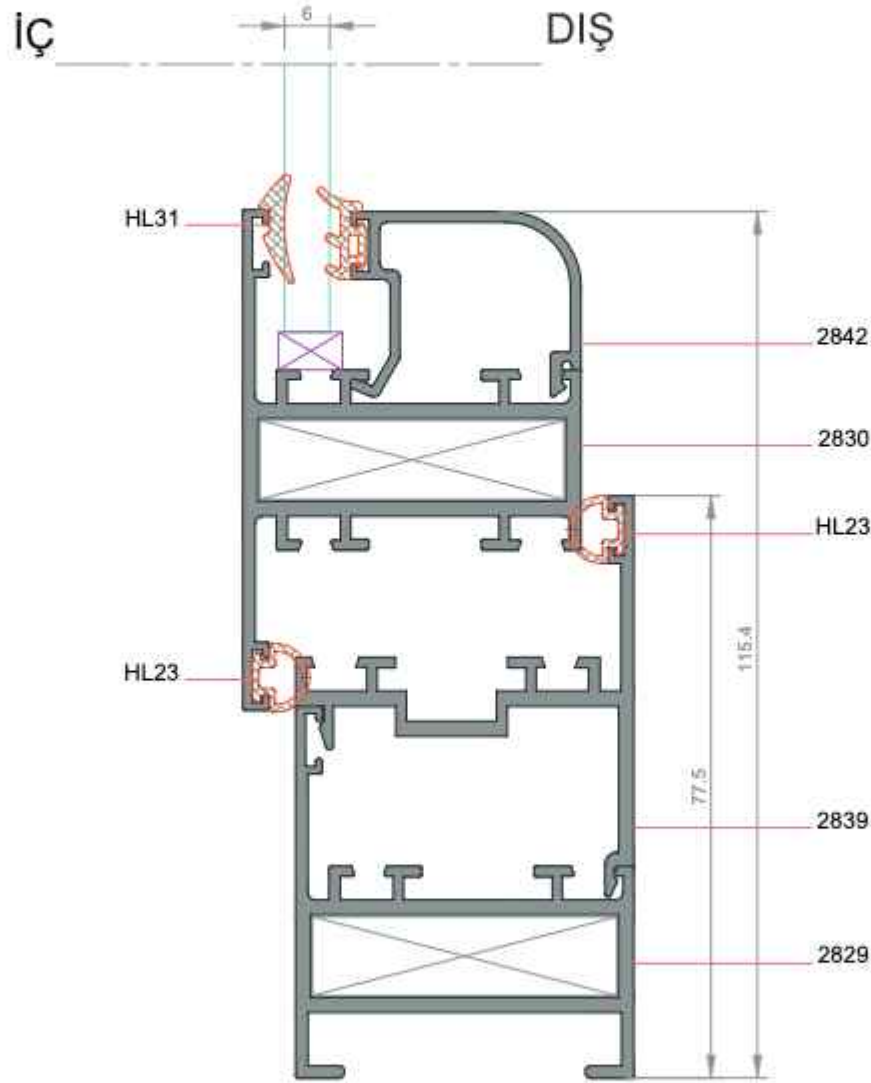
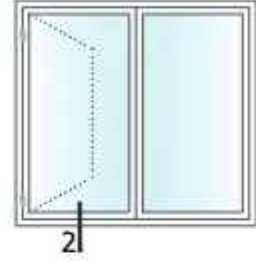

★ Yandaki profil birim ağırlıkları, bilgisayarla hesaplanmış teorik ağırlıklardır.

DETAY- 3
ÖLÇEK:1/1

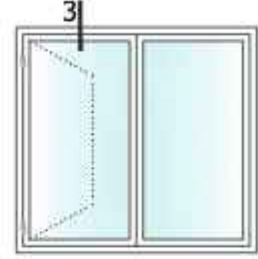

★ Yandaki profil birim ağırlıkları, bilgisayarda hesaplanmış teorik ağırlıklardır.

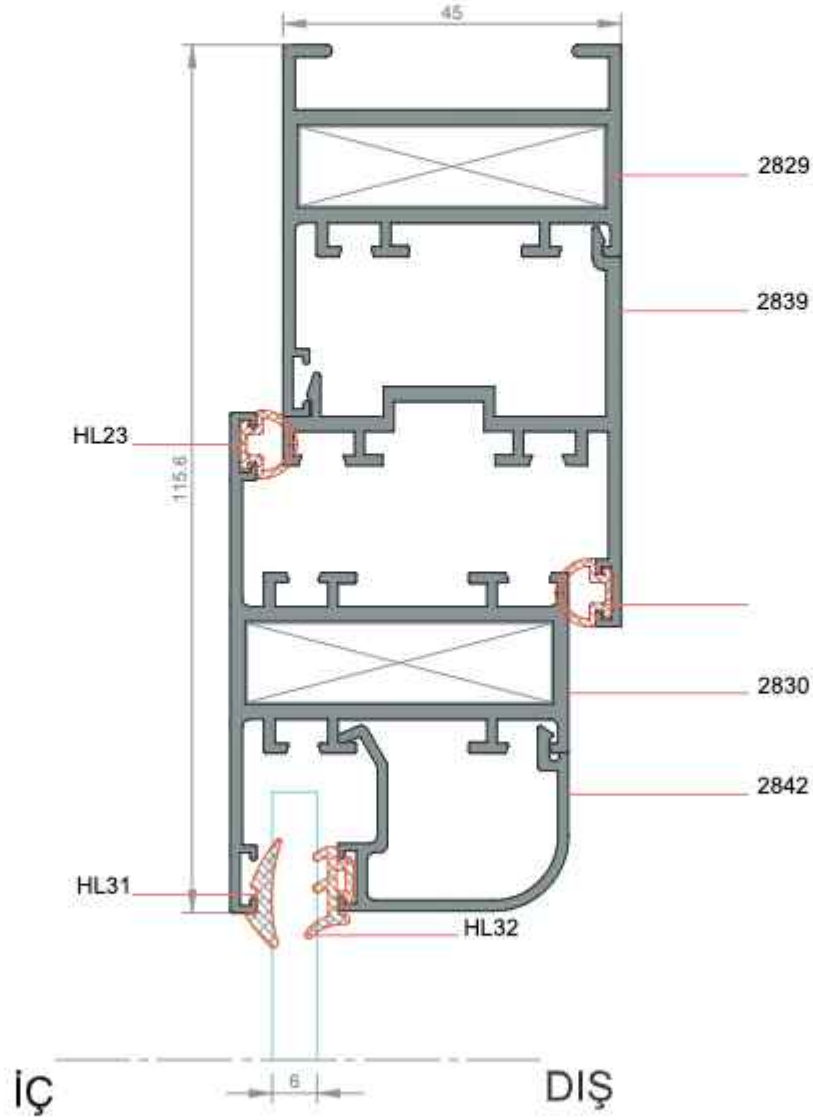

DETAY- 4
ÖLÇEK:1/1

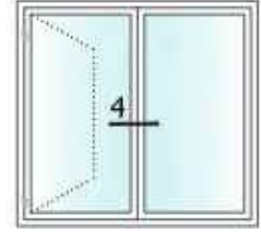

★ Yandaki profil birim ağırlıkları, bilgisayarla hesaplanmış teorik ağırlıklardır.

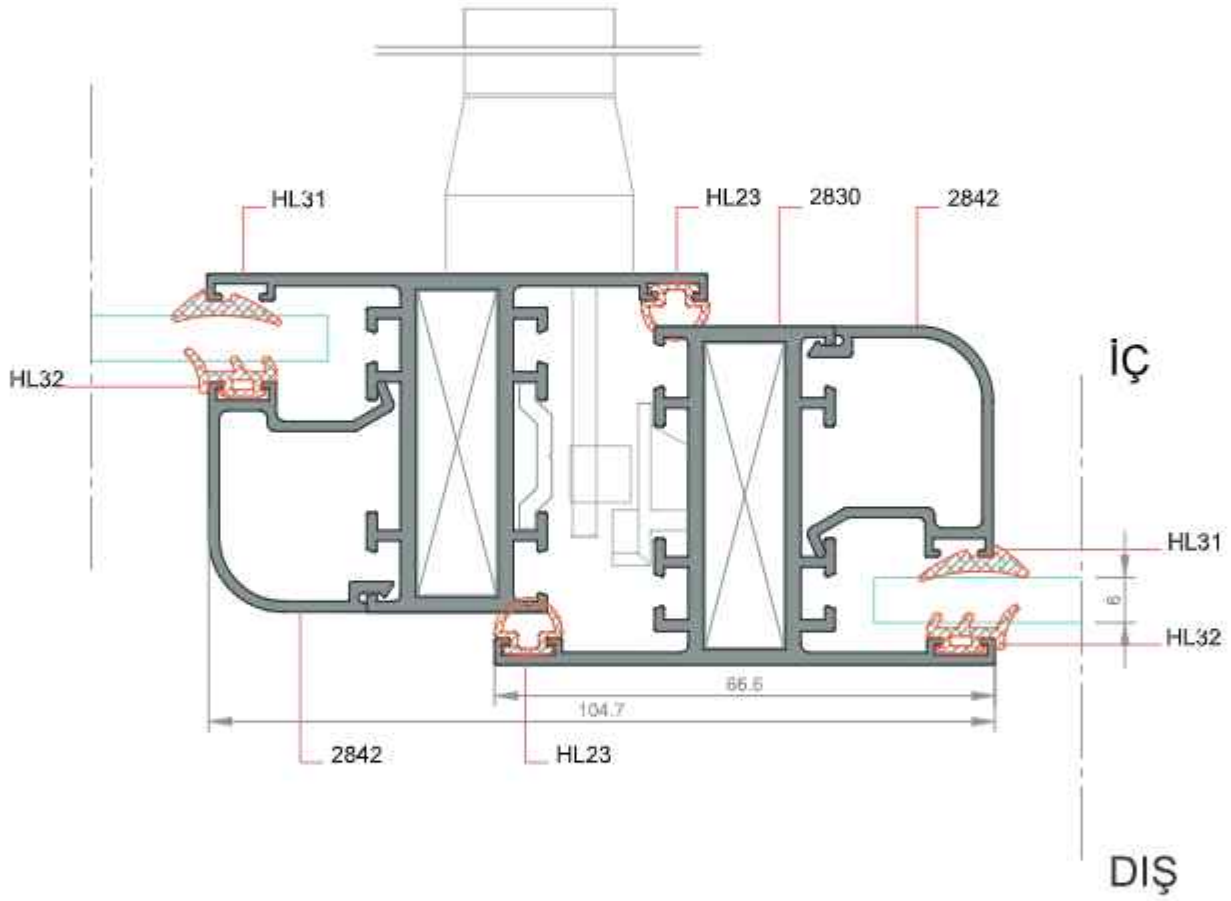

DETAY- 5
ÖLÇEK:1/1

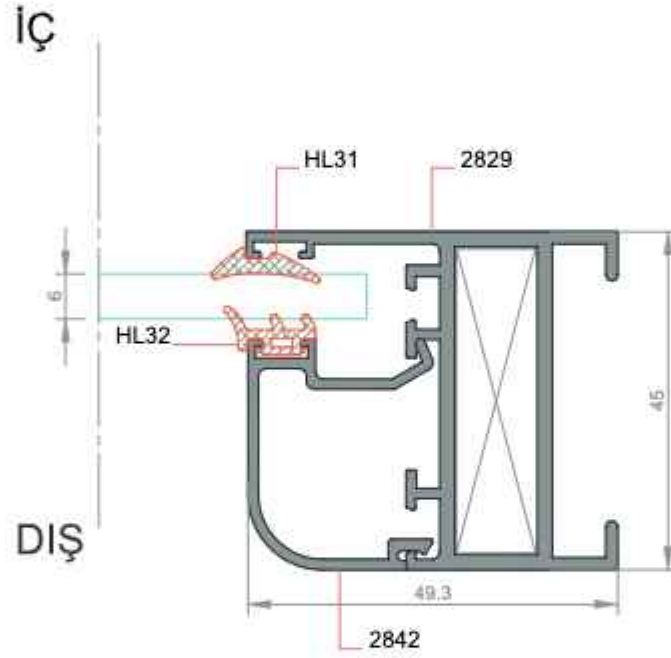
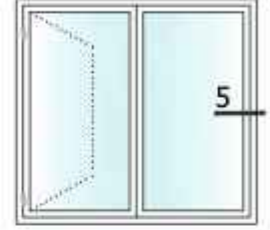

★ Yandaki profil birim ağırlıkları, bilgisayarda hesaplanmış teorik ağırlıklardır.

DETAY- 1a
ÖLÇEK:1/1

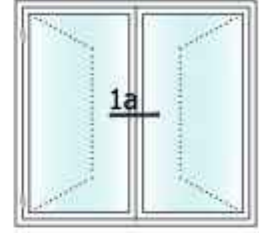

★ Yandaki profil birim ağırlıkları, bilgisayarda hesaplanmış teorik ağırlıklardır.

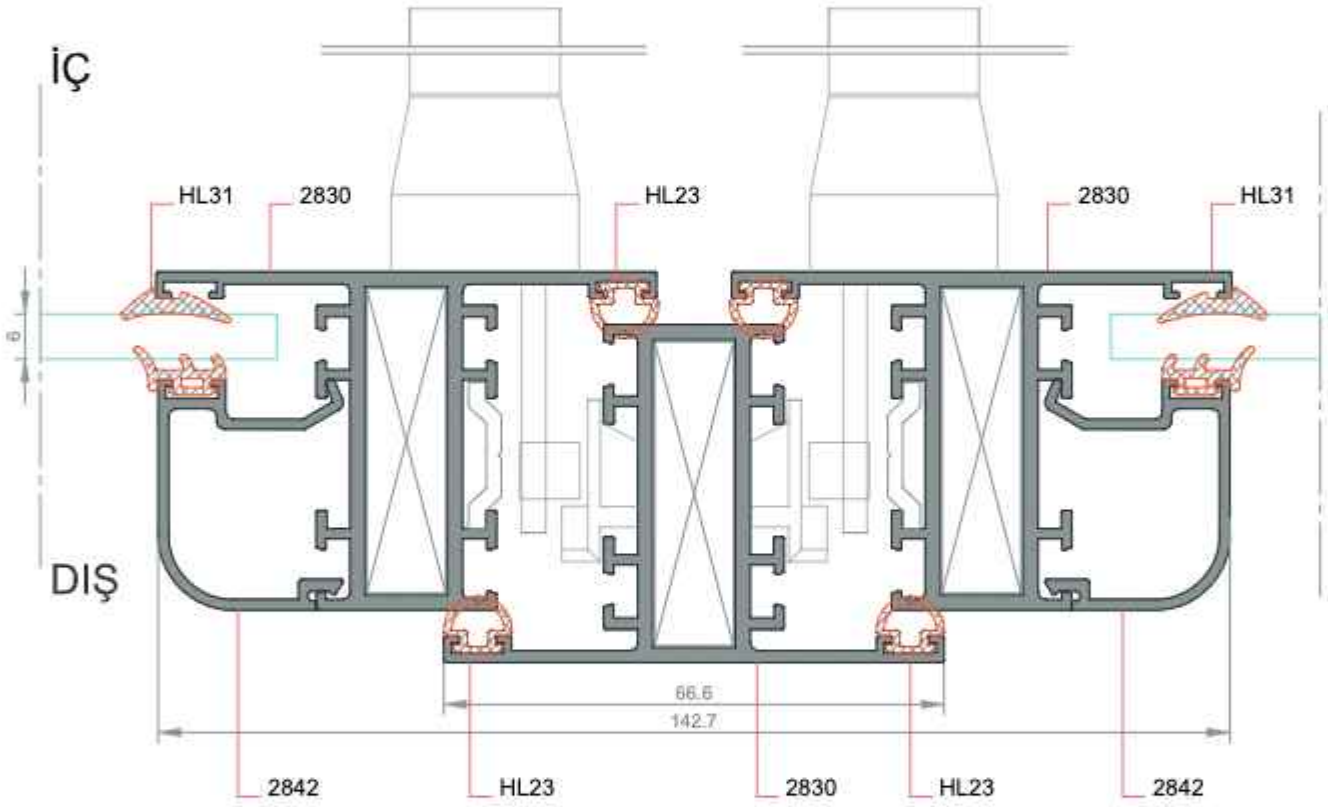

KAPI UYGULAMA TİPLERİ

★ Yandaki profil birim ağırlıkları, bilgisayarda hesaplanmış teorik ağırlıklardır.

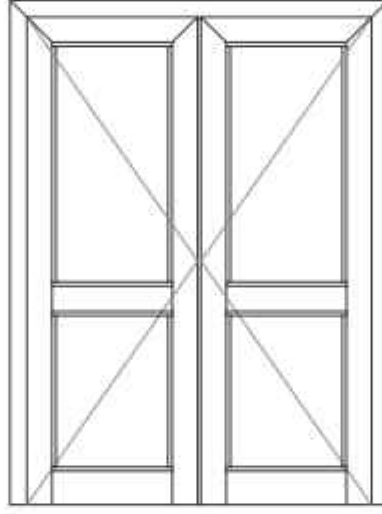

İçe Açılır Kapı

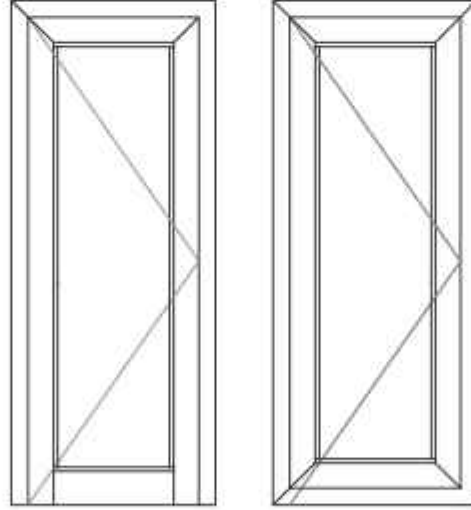

İçe Açılır Kapı

DETAY- 1
ÖLÇEK:1/1

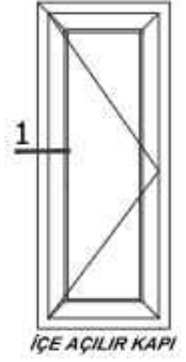

★ Yandaki profil birim ağırlıkları, bilgisayarla hesaplanmış teorik ağırlıklardır.

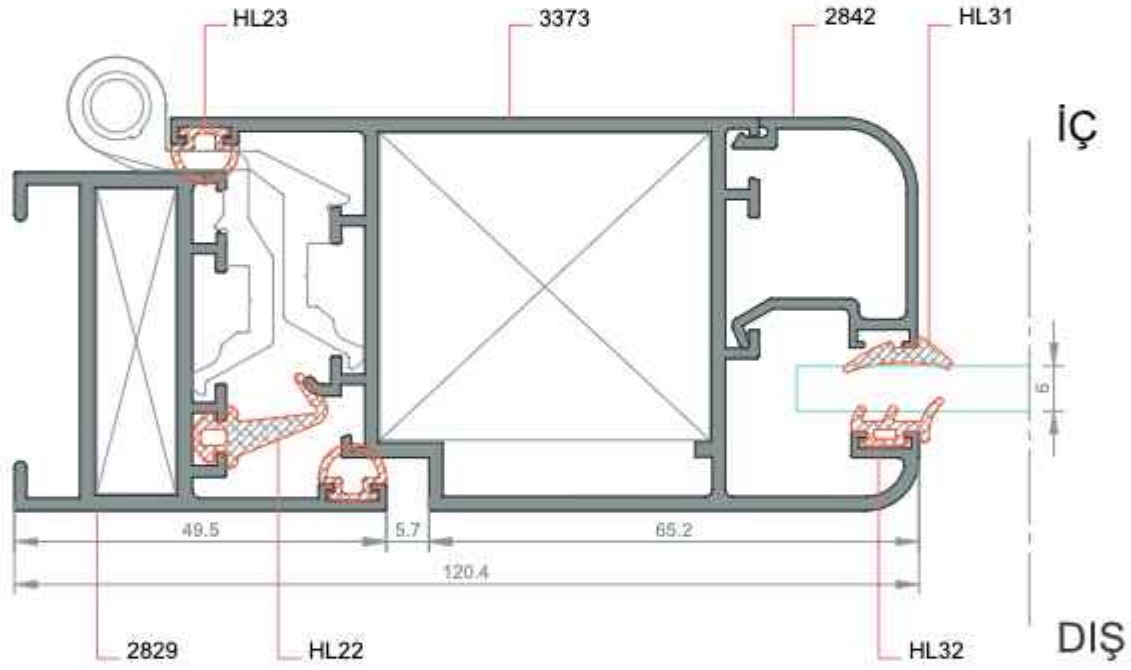

DETAY- 2a
ÖLÇEK:1/1

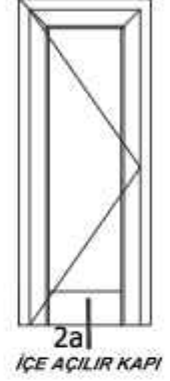
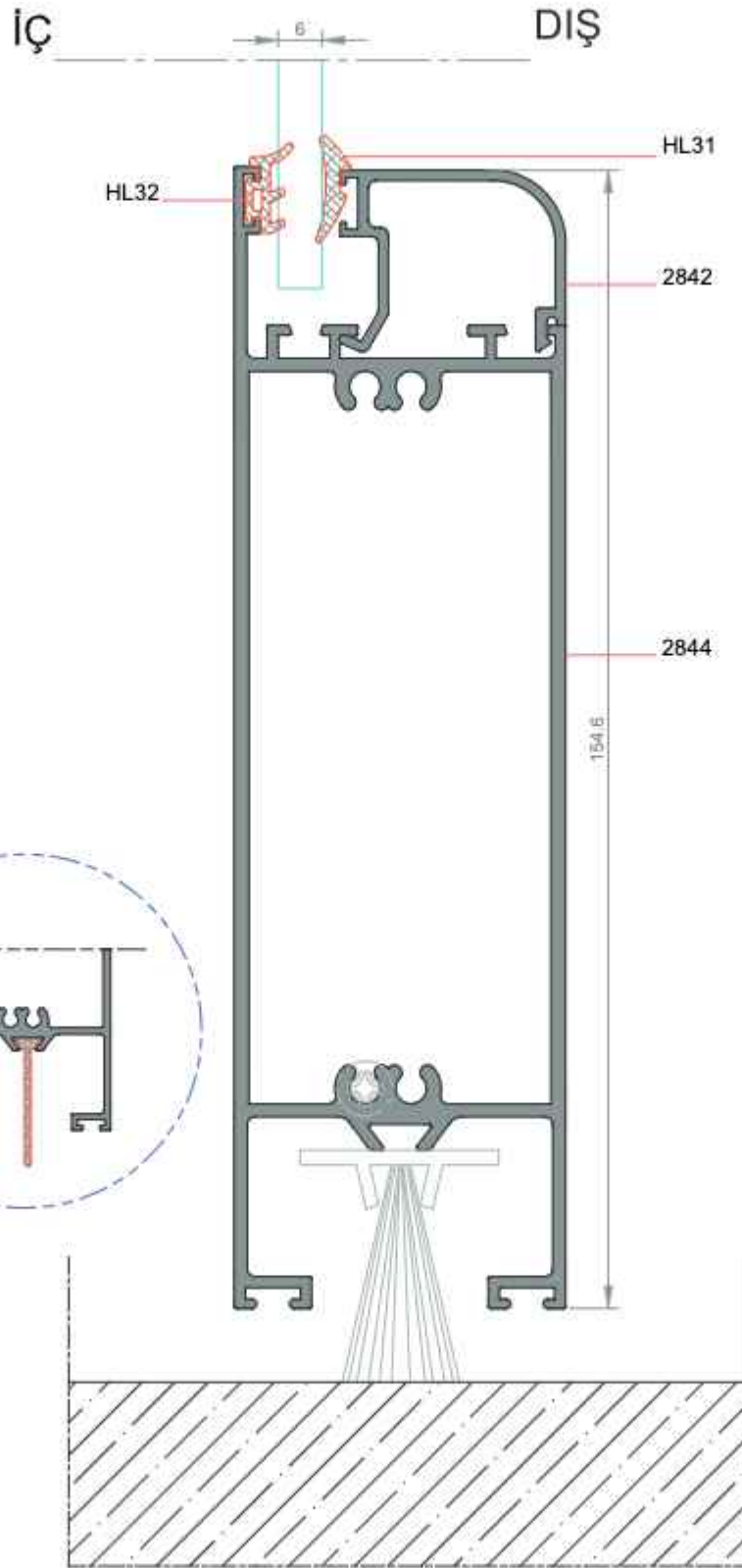

★ Yandaki profil ağırlıkları, bilgisayarda hesaplanmış teorik ağırlıklardır.

DETAY- 2b

ÖLÇEK:1/1

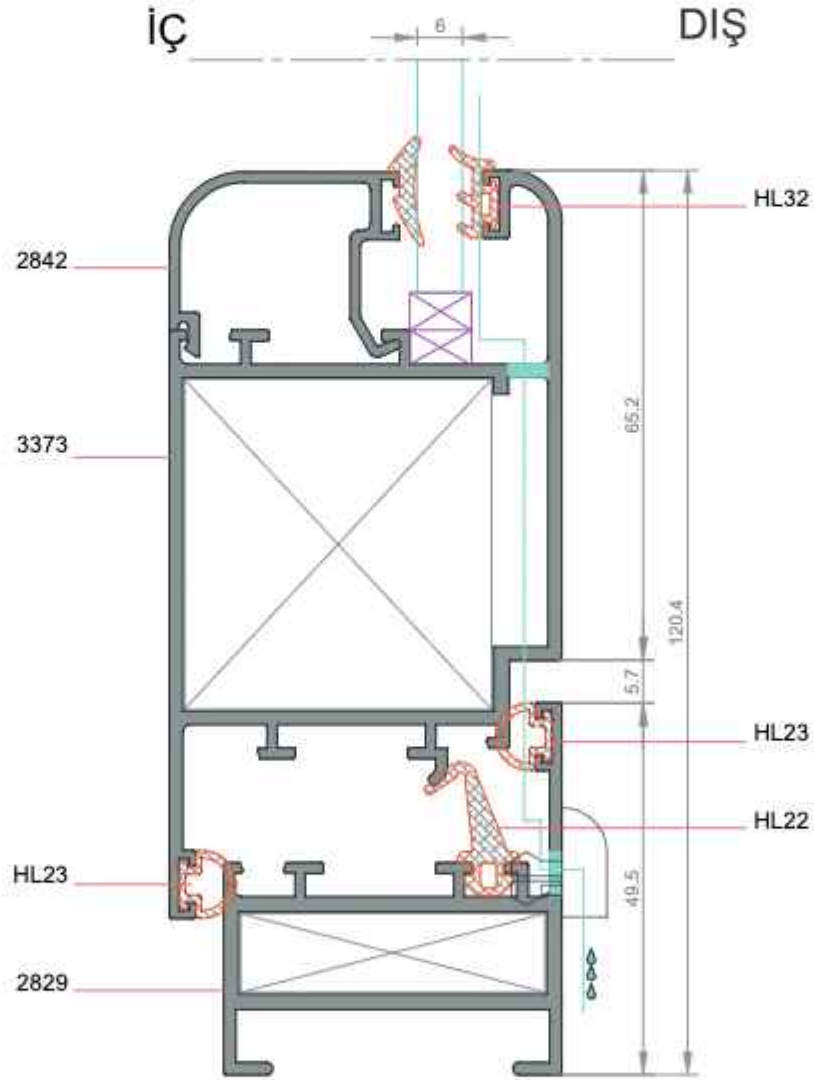
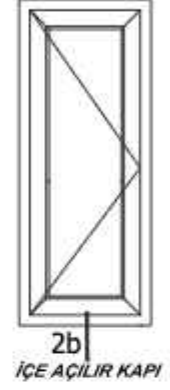

★ Yandaki profil birim ağırlıkları, bilgisayarla hesaplanmış teorik ağırlıklardır.

DETAY- 3
ÖLÇEK:1/1

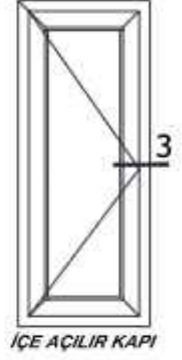

★ Yandaki profil birim ağırlıkları, bilgisayarda hesaplanmış teorik ağırlıklardır.

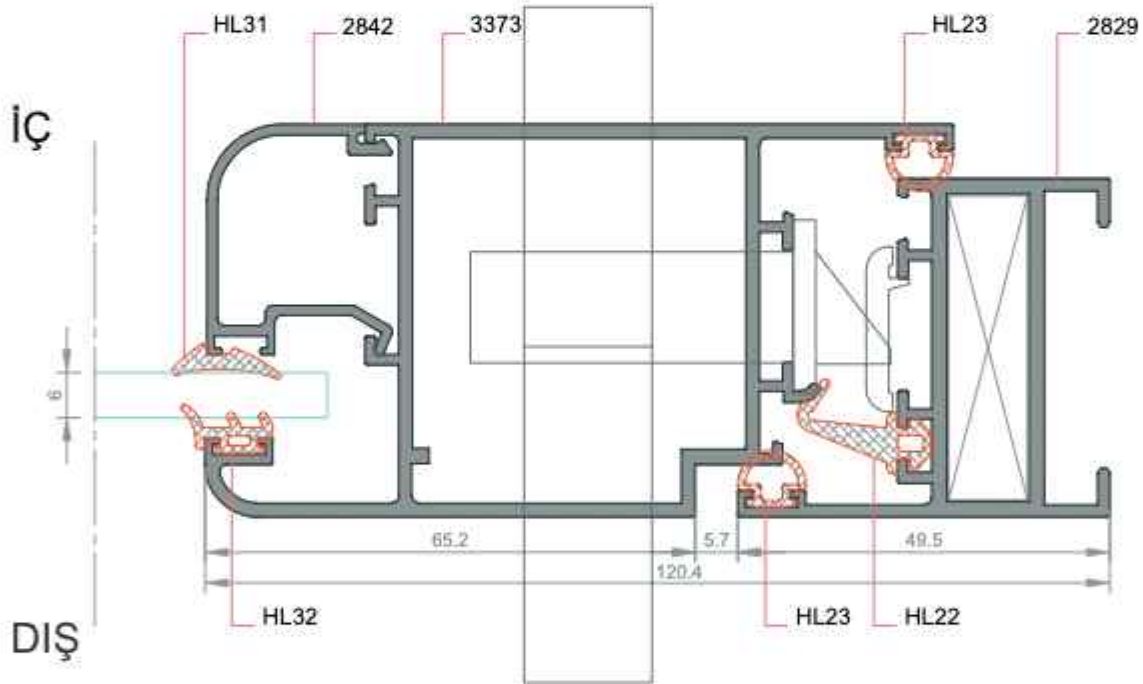

DETAY- 4
ÖLÇEK:1/1

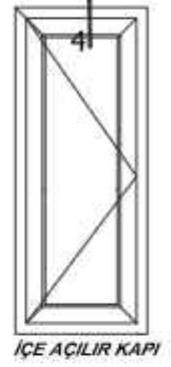

★ Yandaki profil birim ağırlıkları, bilgisayarla hesaplanmış teorik ağırlıklardır.

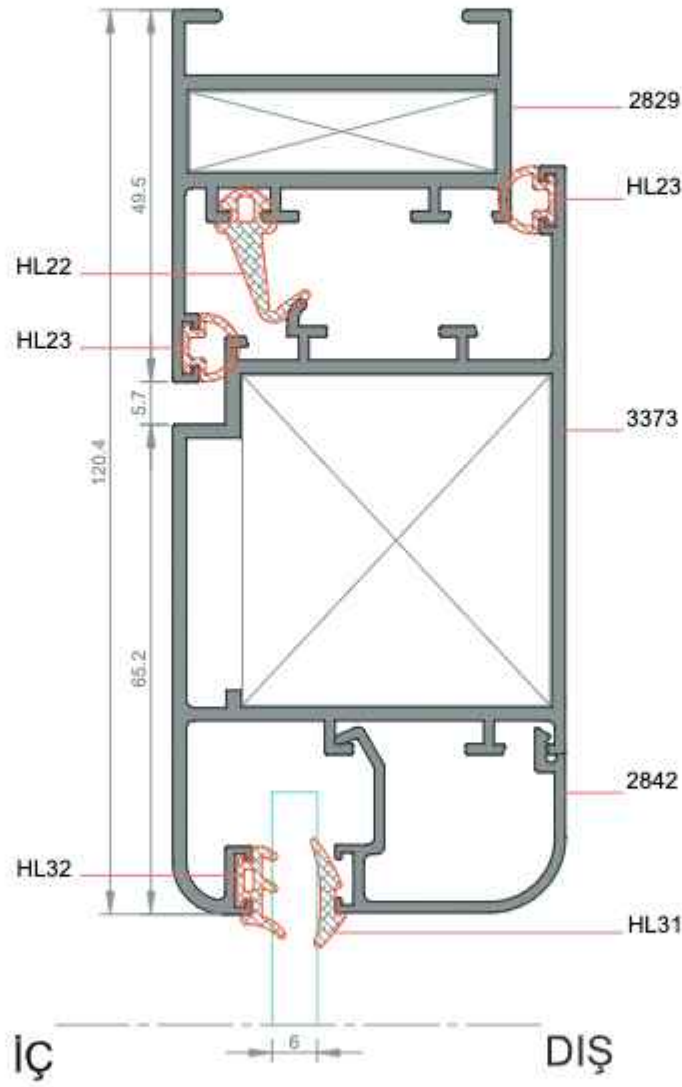

DETAY- 5
ÖLÇEK:1/1

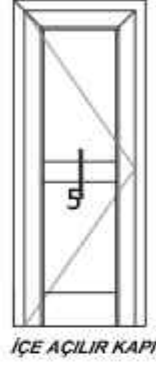

★ Yandaki profil birim ağırlıkları, bilgisayarda hesaplanmış teorik ağırlıklardır.

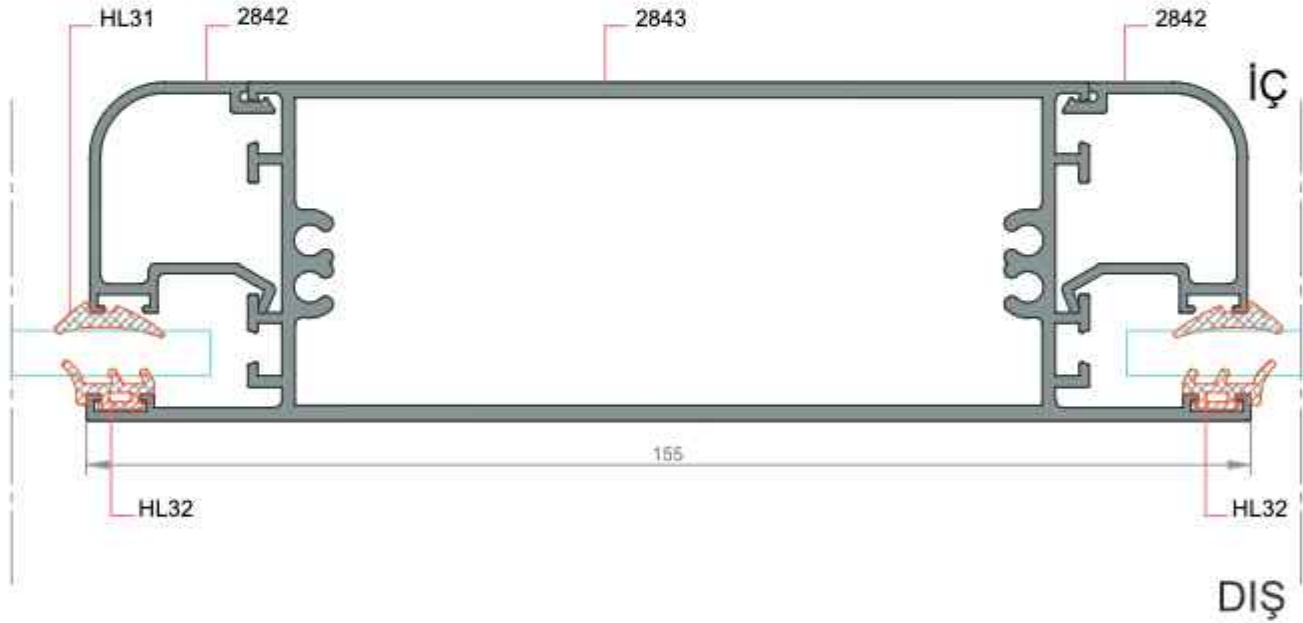

DETAY-1
ÖLÇEK:1/1

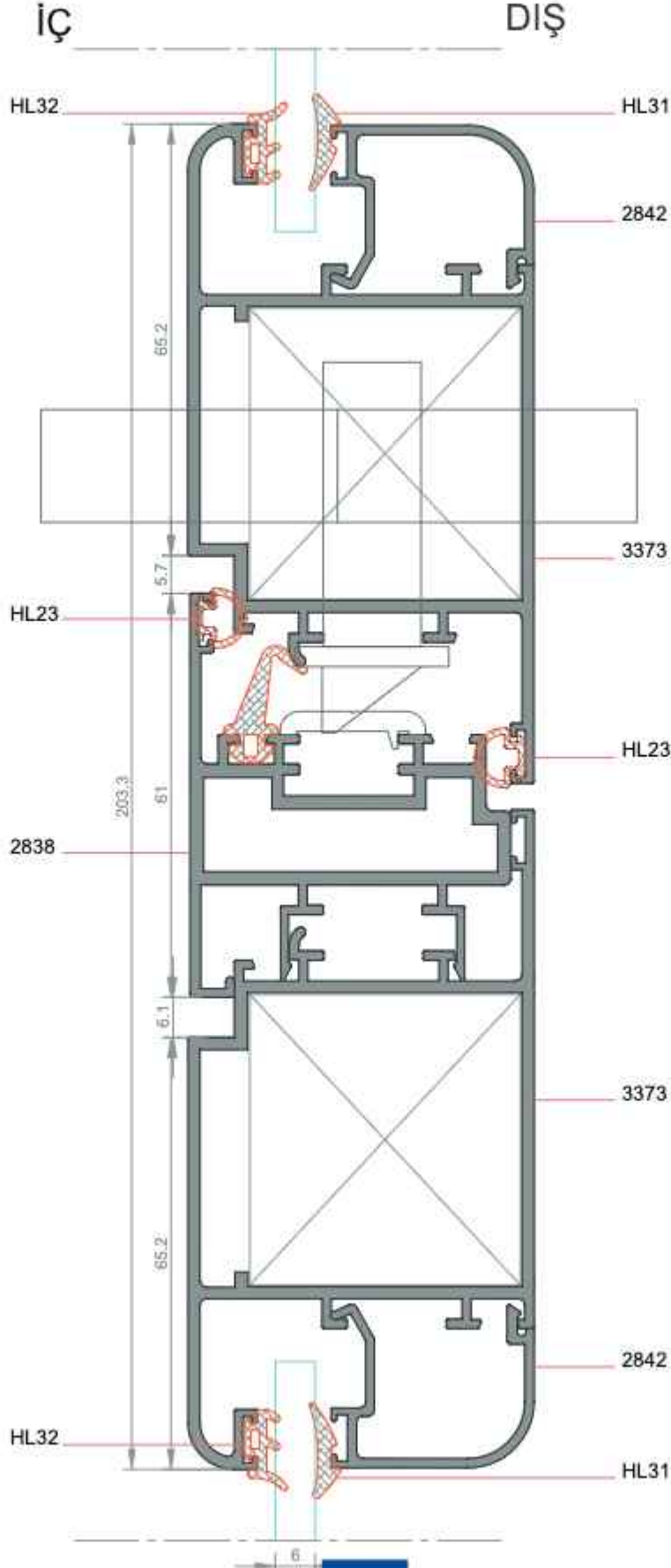

★ Yandaki profil birim ağırlıkları, bilgisayarla hesaplanmış teorik ağırlıklardır.

★ Yandaki profil birim ağırlıkları, bilgisayarda hesaplanmış teorik ağırlıklardır.

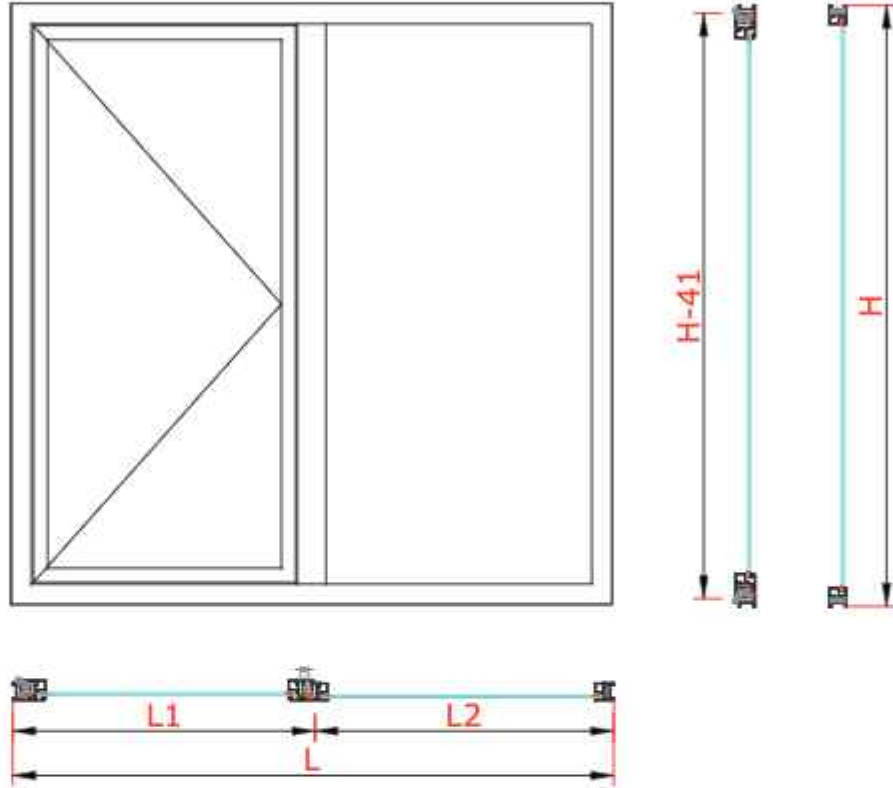

Profilin Adı	Profil Kesiti	Profil Kodu	Adet	Kesim Ölçüsü(mm)
Kasa Profili		2829	2	L
			2	H
Kanat Profili		2830	2	L1-24.8
			2	H-41
Orta Kayıt Profili		2831	1	H-47.4
Cam Çıtası Profili <small>Not: Cam Çıtası profillerinin ölçülerini belirleyen her şeyi kendi ölçülerine kaydediniz.</small>	Kanat	3374	2	
			2	
Cam Çıtası Profili <small>Not: Cam Çıtası profillerinin ölçülerini belirleyen her şeyi kendi ölçülerine kaydediniz.</small>	Kasa Orta Kayıt	3374	2	
			2	

Bağlantı Elemanları	Kod	Birim	Miktar
Köşe Takozu (Kasa)	K2957 405	Adet	4
Köşe Takozu (Kanat)	K2957 405	Adet	4

Cam (Açılır)	Adet	Cam Detayı	Kesim Ölçüsü (mm)
Dış Cam	1		
İç Cam			

Cam (Sabit)	Adet	Cam Detayı	Kesim Ölçüsü (mm)
Dış Cam	1		
İç Cam			

★ Yandaki profil birim ağırlıkları, bilgisayarda hesaplanmış teorik ağırlıklardır.

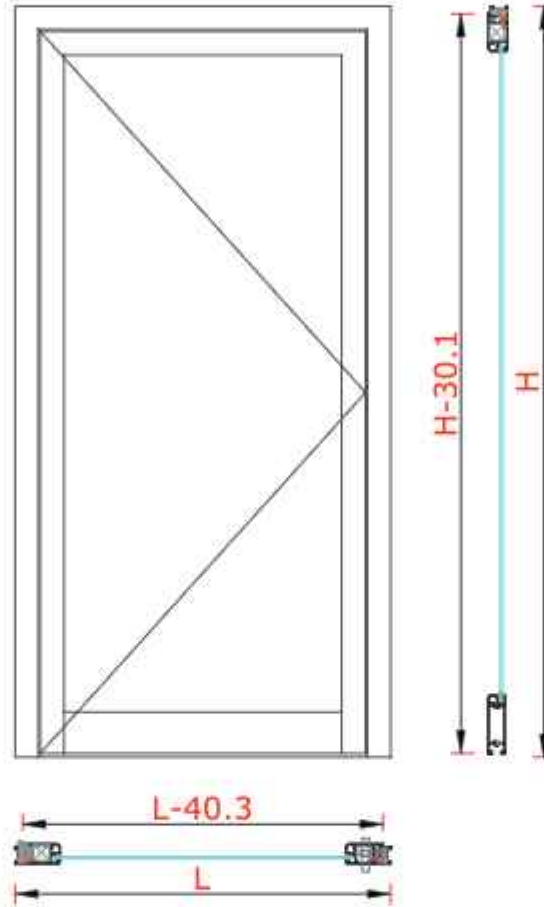

Profilin Adı	Profil Kesiti	Profil Kodu	Adet	Kesim Ölçüsü(mm)
Kasa Profili		2829	1	L
			2	H
Kanat Profili		3373	1	L-40.3
			2	H-30.1
Elek Profili		2844	1	L-187.9
Cam Çıtası Profili	Kanat	2842	2	
			2	

Bağlantı Elemanları	Kod	Birim	Miktar
Köşe Takozu (Kasa)	K2957 405	Adet	2
Köşe Takozu (Kanat)	K3041 408	Adet	2

CAM (Açılır)	Adet	Cam Detayı	Kesim Ölçüsü (mm)
Dış Cam	1		
İç Cam			



METALPLAST GROUP

METALPLAST GROUP – Worldwide DÜNYA ÇAPINDA METALPLAST GRUP

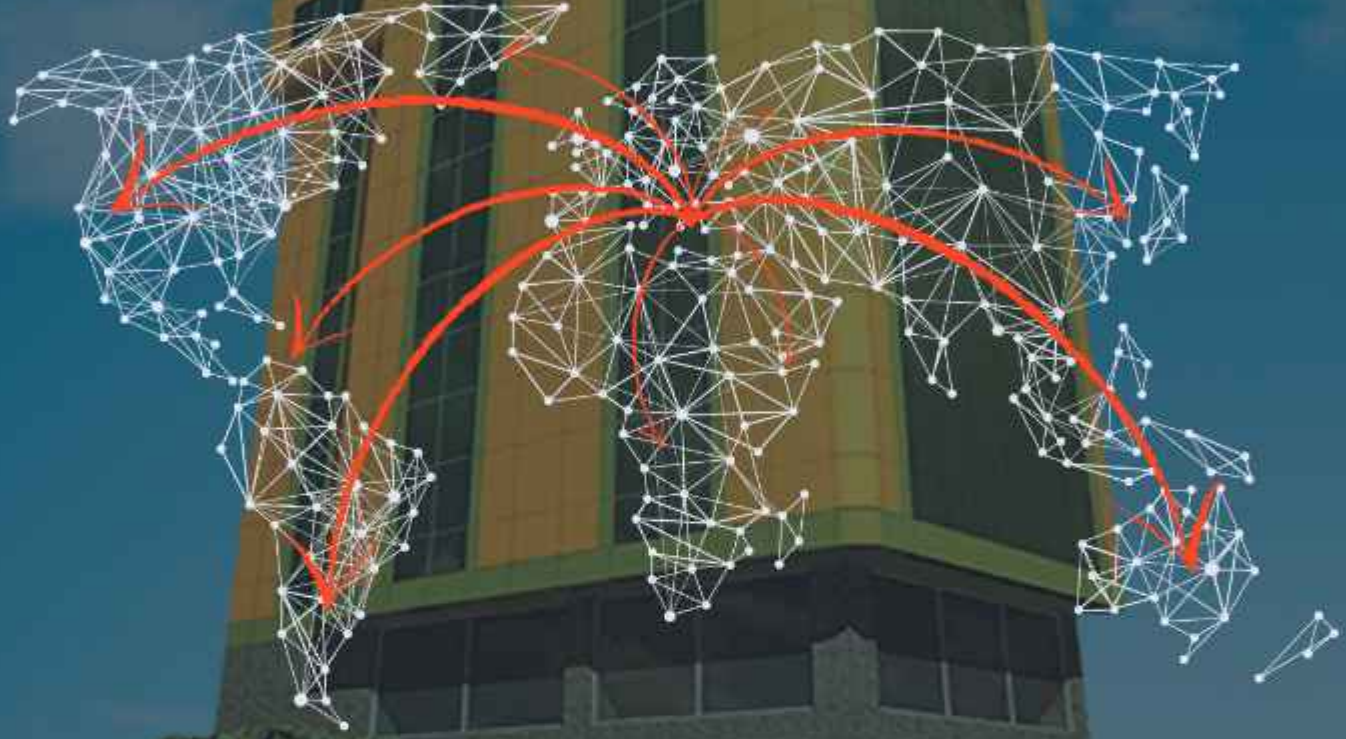

METALPLAST GROUP ALÜMİNYUM TURİZM İTH. İHR. SAN. TİC. LTD. ŞTİ.

Oruçreis Mah. Tekstilkent Cad. 10-V Blok No:214 (2.Kat)
Tekstilkent Ticaret Merkezi Esenler / İstanbul / Türkiye

MPG
METALPLAST GROUP



www.metalplastgroup.com



info@metalplastgroup.com